

Gigaset

ION

Contents

| | |
|--|----|
| Overview | 2 |
| Handset | 2 |
| Charger and USB DECT stick | 3 |
| Symbols in the user guide | 4 |
| Icons | 4 |
| Keys | 4 |
| Safety precautions | 5 |
| Getting started | 6 |
| Package contents | 6 |
| Getting started | 6 |
| Making calls | 10 |
| Making calls | 10 |
| Incoming calls | 10 |
| During a call | 10 |
| LED displays | 12 |
| Charge level indicator | 12 |
| LED displays during use | 13 |
| Customer Service & Help | 14 |
| Guarantee Certificate - United Kingdom and Ireland | 14 |
| Manufacturer's advice | 15 |
| Authorisation | 15 |
| Data protection | 15 |
| Environment | 16 |
| Care | 16 |
| Contact with liquid | 16 |
| Technical data | 17 |

Overview

Handset

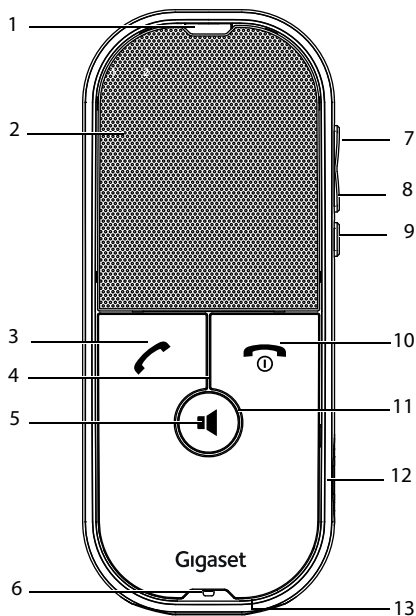

- 1 **Proximity sensor**
- 2 **Speaker**
- 3 **Talk key**
- 4 **"Mute" LED**
Accept call; put call on hold;
- 5 **Handsfree key**
Mute indicator (ON or OFF)
- 6 **Microphone**
- 7 **Volume +**
- 8 **Volume -**
- 9 **Muting**
- 10 **End call key, On/Off key**
Accept call; switch between earpiece and handsfree modes
- 11 **Ring LED**
End call; switch phone on/off
- 12 **Micro-USB C socket**
LED status display; for functions, see "LED displays", p. 12
- 13 **Charge contacts**
USB cable for charging or manual software update

Charger and USB DECT stick





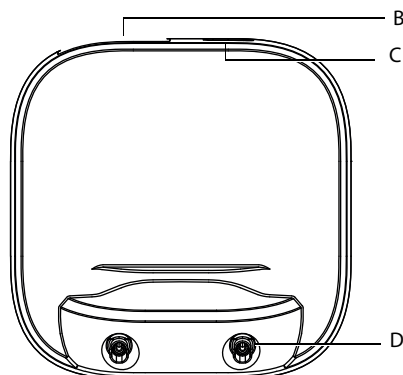

- A **A USB DECT stick**
Connects the handset to the charger or PC/laptop







- B **B USB slot for USB DECT stick**
C **C USB C port**
For connecting a USB cable between PC/laptop and charger
D **D Charge contacts for handset**

Symbols in the user guide

Icons

| | |
|--|---|
|  | Warnings, the non-adherence to which can result in damage to devices or personal injury. |
|  | Important information regarding function and appropriate handling or functions that could generate costs. |
|  | Prerequisite for carrying out the following action. |
|  | Additional helpful information. |

Keys

| | | | |
|--|-------------|---|--------------------------|
|  | Talk key |  | End call key, On/Off key |
|  | Speaker key |  | Mute key |
|  | Volume +/- | | |

Safety precautions



Read the safety precautions and the user guide before use.

Comprehensive user guides for all telephones and telephone systems as well as for accessories can be found online at gigasetpro.com in the Support category. We thereby help to save paper while providing fast access to the complete up-to-date documentation at any time.



The device cannot be used in the event of a power failure. In case of a power failure it is also **not** possible to make **emergency calls**.



Use only **rechargeable batteries** that correspond to the **specification** (see list of permitted batteries → www.gigaset.com/service). Never use a conventional (non-rechargeable) battery or other battery types as this could result in significant health risks and personal injury. Rechargeable batteries, which are noticeably damaged, must be replaced.



The handset must not be operated if the battery cover is open.



Do not use the devices in environments with a potential explosion hazard (e.g. paint shops).



The devices are not splashproof. For this reason do not install them in a damp environment such as bathrooms or shower rooms.



Remove faulty devices from use or have them repaired by our Service team, as these could interfere with other wireless services.



Keep small cells and batteries, which can be swallowed, out of the reach of children.

Swallowing a battery can lead to burns, perforation of soft tissue and death. Severe burns can occur within 2 hours of swallowing.
In the case of a swallowed cell or battery, seek medical care immediately.



Using your telephone may affect nearby medical equipment. Be aware of the technical conditions in your particular environment, e.g. doctor's surgery. If you use a medical device (e.g. a pacemaker), please contact the device manufacturer. They will be able to advise you regarding the susceptibility of the device to external sources of high frequency energy (for the specifications of your Gigaset product see "Technical data").



Clean the proximity sensor occasionally to guarantee correct and safe function.

Getting started

Package contents

- one Gigaset ION handset
- one battery cover
- one charger
- one USB DECT stick
- one charger cable for charging from a PC and for data transfers
- two AAA batteries

Getting started

Soft client



To make calls, the installation of a soft client is required on the PC/laptop connected, and a working Internet connection. The handset can not be used without the soft client and Internet connection.

Detailed information on compatible soft clients is available from:

→ wiki.gigasetpro.com.

ION app

From the app, software updates for the handset and USB DECT stick can be performed.

Also, different user settings can be configured, such as

- ▶ automatic call accept on removing from the charging cradle
- ▶ automatic ending of call on placing back into the charging cradle

detailed information on our app and software updates

→ wiki.gigasetpro.com.

Inserting the batteries and closing the cover

- ▶ Insert the batteries.
- ▶ Carefully press down the cover (included) until it clicks into place.

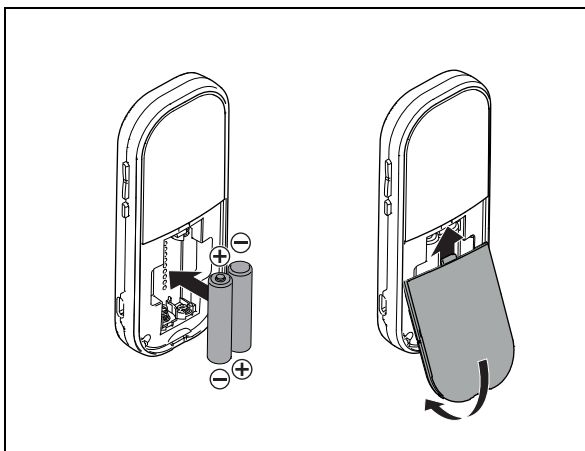

Connection option 1: Charger with USB DECT stick on laptop/PC

Plug in the USB DECT stick

- ▶ Plug the USB DECT stick into the USB slot on the charger.

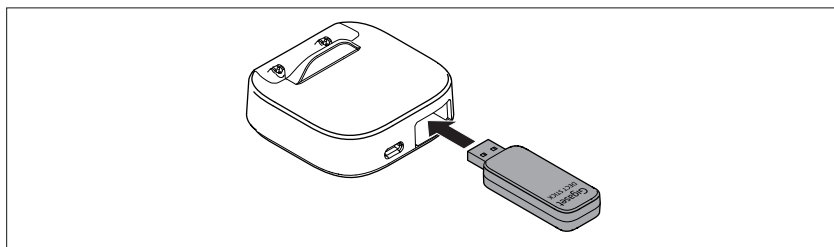

Connecting the charger

- ▶ Use the USB cable to connect the charger to the laptop/PC.

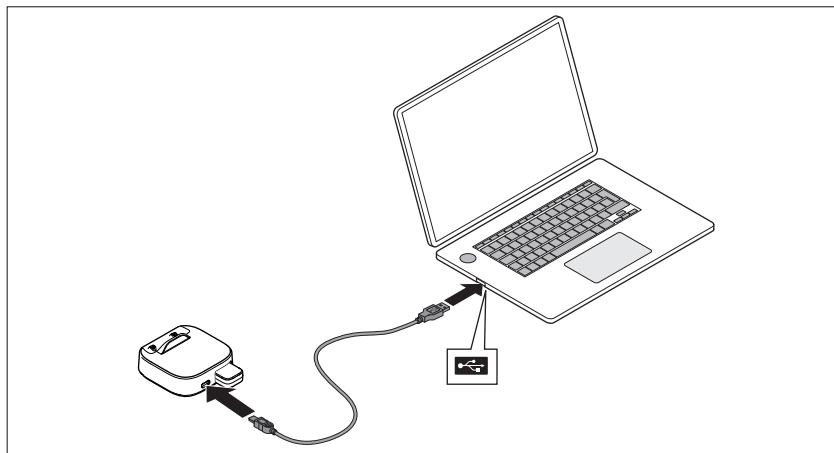

Charge the batteries

- ▶ Place the handset into the charger.
 - This automatically turns on the handset and the software is installed automatically.
 - The LED charge level indicator shows the current charge level.



The battery is fully charged when the LED charge level indicator shows a full green circle.

The batteries can be used straight away. There is no need for full charging prior to initial use.

Connection option 2: USB DECT stick directly on laptop/PC

Plug in the USB DECT stick

- ▶ Plug the USB DECT stick into the laptop/PC.

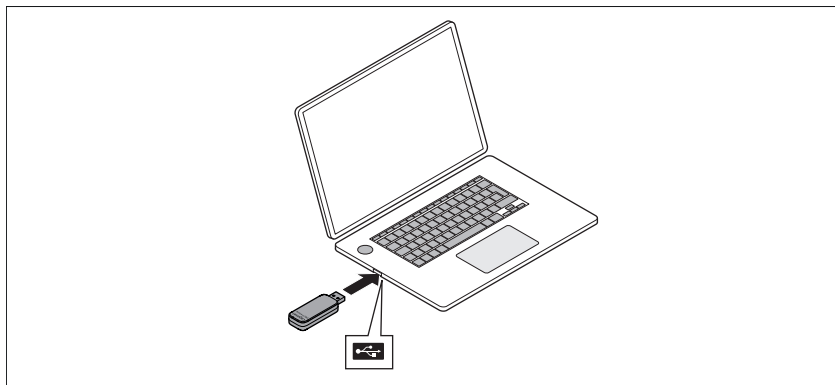

Charge the batteries

- ▶ Connect a compatible USB-C charger to the handset.
 - This automatically turns on the handset and the software is installed automatically.
 - The LED charge level indicator shows the current charge level.



The battery is fully charged when the LED charge level indicator shows a full green circle.

The batteries can be used straight away. There is no need for full charging prior to initial use.

Making calls



The “Call”, “Accept call” and “End call” functions are based on the functionality of the soft client. It is possible that not all functions work the same way with every soft client.

Making calls

- ▶ Press **briefly** the Talk key  on the handset.



Cancel the call or dialling process:

- ▶ Press the End call key .

Incoming calls

An incoming call is indicated by ringing and blue flashing of the ring LED.

Accept the call:

- ▶ Press the Talk key  or Handsfree key . This function is dependent on the software client used.

or:

- ▶ Remove the handset from the charger.

During a call

Handsfree mode



Enable/disable Handsfree mode during a call and when the connection is being established:

- ▶ Press the handsfree key .



Your handset also switches to Handsfree mode when you hold it in front of you instead of to your ear. The proximity sensor is used for this.

Placing a handset in the charger during a call:

- ▶ Press and hold down the Handsfree key .
- ▶ Place the handset in the charger and keep the Handsfree key  pressed for 2 more seconds.

Call volume

During a call:

- ▶ Press the Volume keys  on the right of the handset: at the top for louder and bottom for quieter, until the required volume is reached.
- ▶ A signal sounds when the maximum or minimum volume is reached.

Muting the microphone

When the microphone is switched off, callers will no longer hear you.

During a call:



- ▶ Press the microphone key .





Cancelling muting:

- ▶ Press the microphone key  again.



LED displays

Charge level indicator

| Place the handset into the charger | | |
|---|--|--|
| LED status | | Meaning |
|  | The ring LED moves in a circle (green) | The handset is charging. Charging already taken place is indicated by continuously lit LEDs |
|  | The ring LED lights up full in green | The handset is charged 100% |
|  | The ring LED does not light up | The batteries inserted are not permitted or No batteries are inserted |

| Handset in Standby mode (not in the charger) | | |
|--|--|-----------------------------|
| LED status | | Meaning |
|  | 1 segment of the ring LED lighting orange | The handset is charged 25% |
|  | 2 segments of the ring LED lighting orange | The handset is charged 50% |
|  | 3 segments of the ring LED lighting green | The handset is charged 75% |
|  | The ring LED lights up full in green | The handset is charged 100% |

LED displays during use

| LED status | Meaning | |
|---|---|--|
|  | Ring LED lights red after the End call key is pressed for long time | The handset is powered off |
| | Ring LED flashes blue | Incoming call |
| | Ring LED lights light blue | Active call in Handsfree mode |
| | Ring LED lights dark blue | Active call in Earpiece mode |
| | Ring LED lights white when the handset is switched on | LED signals registration. LED goes out as soon as the handset is registered with the charger. |
| | Ring LED flashes white | No longer a wireless connection to the charger |
| | Ring LED flashes orange in Standby mode | Missed call |
| | Ring LED flashes red quickly | No longer a wireless connection to the laptop/PC |
|  | "Mute" LED flashes orange during a call | Microphone is muted |

Appendix

Customer Service & Help

Do you have any questions?

For quick help and information, please refer to this user guide or visit gigasetpro.com.

For online information and services concerning

- Products
- Documents
- Interop
- Firmware
- FAQ
- Support

please refer to wiki.gigasetpro.com.

For further information our Gigaset specialised reseller will be happy to help you related to your Gigaset product.

Guarantee Certificate - United Kingdom and Ireland

Without prejudice to any claim the user (customer) may have in relation to the dealer or retailer, the customer shall be granted a manufacturer's Guarantee under the conditions set out below:

- In the case of new devices and their components exhibiting defects resulting from manufacturing and/or material faults within 24 months of purchase, Gigaset Communications shall, at its own option and free of charge, either replace the device with another device reflecting the current state of the art, or repair the said device. In respect of parts subject to wear and tear (including but not limited to, batteries, keypads, casing), this warranty shall be valid for six months from the date of purchase.
- This Guarantee shall be invalid if the device defect is attributable to improper care or use and/or failure to comply with information contained in the user manuals. In particular claims under the Guarantee cannot be made if:
 - The device is opened (this is classed as third party intervention)
 - Repairs or other work done by persons not authorised by Gigaset Communications.
 - Components on the printed circuit board are manipulated
 - The software is manipulated
 - Defects or damage caused by dropping, breaking, lightning or ingress of moisture. This also applies if defects or damage was caused by mechanical, chemical, radio interference or thermal factors (e.g.: microwave, sauna etc.)
 - Devices fitted with accessories not authorised by Gigaset Communications
- This Guarantee shall not apply to or extend to services performed by the authorised dealer or the customer themselves (e.g. installation, configuration, software downloads). User manuals and any software supplied on a separate data medium shall be excluded from the Guarantee.
- The purchase receipt, together with the date of purchase, shall be required as evidence for invoking the Guarantee. Claims under the Guarantee must be submitted within two months of the Guarantee default becoming evident.
- Ownership of devices or components replaced by and returned to Gigaset Communications shall vest in Gigaset Communications.
- This Guarantee shall apply to new devices purchased in the European Union. For Products sold in the United Kingdom and in the Republic of Ireland the Guarantee is issued by: Gigaset Communications UK Limited, 2 White Friars, Chester, CH1 1NZ.
- Any other claims resulting out of or in connection with the device shall be excluded from this Guarantee. Nothing in this Guarantee shall attempt to limit or exclude a Customers Statutory Rights, nor the manufacturer's liability for death or personal injury resulting from its negligence.

- The duration of the Guarantee shall not be extended by services rendered under the terms of the Guarantee.
- Insofar as no Guarantee default exists, Gigaset Communications reserves the right to charge the customer for replacement or repair.
- The above provisions do not imply a change in the burden of proof to the detriment of the customer.

To invoke this Guarantee, please contact the Gigaset Communications helpdesk. This number is also to be found in the accompanying user guide.

Exclusion of liability



Signs of wear on the display and casing are excluded from the warranty.

Certain content and services which can be accessed using this device are the property of third parties and are protected by copyrights, patents, trademarks and/or other laws for the purpose of safeguarding intellectual property. Such content and services are provided solely for non-commercial, private usage. You may not use content or services which has/have not been authorised by the owner of particular content or a service provider. Without limiting the generality of the foregoing, except as expressly specified by the owner of the content or the service provider, the modification, reproduction, dissemination, uploading, publication, transmission, translation, sale, creation of derived works, distribution of content or services shown on this device are not permitted in any form and on any medium.

Manufacturer's advice

Authorisation

This device is intended for use worldwide. Use outside the European Economic Area (with the exception of Switzerland) is subject to national approval.

Country-specific requirements have been taken into consideration.

Hereby, Gigaset Communications GmbH declares that the radio equipment type Gigaset ION is in compliance with Directive 2014/53/EU and the UK Radio Equipment Regulations 2017.

The full text of the EU and UK declaration of conformity is available at the following internet address:

www.gigaset.com/docs.

This declaration could also be available in the "International Declarations of Conformity" or "European Declarations of Conformity" files.

Therefore please check all of these files.

Data protection

We at Gigaset take the protection of our customers' data very seriously. It is precisely for this reason that we are ensuring all our products feature "Privacy by Design" as standard. All information we collect is used to make our products as good as possible. In the process, we ensure your details are protected and only used for the purposes of making available to you a product or service. We know which path your data takes through the company and ensure this happens in line with data protection specifications in a secure and protected manner.

The full text of the privacy policy is available from: www.gigaset.com/privacy-policy

Environment

Environmental management system



Gigaset Communications GmbH is certified pursuant to the international standards ISO 14001 and ISO 9001.

ISO 14001 (Environment): Certified since September 2007 by TÜV SÜD Management Service GmbH.

ISO 9001 (Quality): Certified since 17/02/1994 by TÜV SÜD Management Service GmbH.

Disposal

Batteries should not be disposed of in general household waste. Observe the local waste disposal regulations, details of which can be obtained from your local authority.

All electrical and electronic products should be disposed of separately from the municipal waste stream via designated collection facilities appointed by the government or the local authorities.



This crossed-out wheeled bin symbol on the product means the product is covered by the European Directive 2012/19/EU.

UK: The Waste Electrical and Electronic Equipment Regulations 2013.

The correct disposal and separate collection of your old appliance will help prevent potential negative consequences for the environment and human health. It is a precondition for reuse and recycling of used electrical and electronic equipment.

For more detailed information about disposal of your old appliance, please contact your local council refuse centre or the original supplier of the product.

Care

Wipe the device with a **damp** cloth or an antistatic cloth. Do not use solvents or microfibre cloths.

Never use a dry cloth; this can cause static.

In rare cases, contact with chemical substances can cause changes to the device's exterior. Due to the wide variety of chemical products available on the market, it was not possible to test all substances.

Impairments in high-gloss finishes can be carefully removed using display polishes for mobile phones.

Contact with liquid

If the device comes into contact with liquid:

- 1 Unplug all cables from the device.
- 2 **Remove the batteries and leave the battery compartment open.**
- 3 Allow the liquid to drain from the device.
- 4 Pat all parts dry.
- 5 Place the device in a dry, warm place **for at least 72 hours** (not in a microwave, oven etc.) with the battery compartment open and the keypad facing down (if applicable).
- 6 **Do not switch on the device again until it is completely dry.**

When it has fully dried out, you will normally be able to use it again.

Technical data

General technical details

| | |
|--|--|
| DECT standard | supported |
| CAT-iq standard | Certified in accordance with standard CAT-iq 2.0 with HD Voice www.dect.org/cat-iq-certification.aspx |
| GAP standard | supported |
| No. of channels | 60 duplex channels |
| Radio frequency range | 1880 - 1900 MHz |
| Duplex mode | Time division multiplexing, 10 ms frame length |
| Repetition frequency of the transmission pulse | 100 Hz |
| Duration of the transmission pulse | 370 µs |
| Channel grid | 1728 kHz |
| Bit rate | 1152 Kbit/s |
| Modulation | GFSK |
| Speech coding | 32 Kbit/s |
| Transmission power | 10 mW average power per channel, 250 mW pulse power |
| Range | Up to 50 m indoors, up to 300 m outdoors |
| Environmental conditions for operation | +5°C to +45°C, 20% to 75% relative humidity |

Batteries

| | |
|-------------|--------------|
| Technology: | 2 x AAA NiMH |
| Voltage: | 1.2 V |
| Capacity: | 750 mAh |

Handset operating times/charging times

The operating time of your Gigaset depends on the capacity of the battery, its age and the way it is used (all times are maximums).

| | |
|---|-----|
| Standby time (hours) | 280 |
| Talktime (hours) | 14 |
| Operating time for 1.5 h of calls per day (hours) | 120 |
| Charging time in charging cradle (hours) | 16 |

Power consumption of the handset in the charging cradle

| | |
|--------------------------------|---------------|
| When charging: | approx. 1.5 W |
| To maintain the charge status: | approx. 0.5 W |

Issued by
Gigaset Communications GmbH
Frankenstr. 2a, 46395 Bocholt, Germany

© Gigaset Communications GmbH 2021
Subject to availability.
All rights reserved. Rights of modification reserved.
www.gigaset.com