

Gigaset pro

N610 IP PRO

Installation, configuration and operation

Content

Gigaset DECT IP PRO devices – overview	4
N610 IP PRO – Introduction	5
Overview	7
First steps	8
Package content	8
Mounting the device	8
Wall mounting	10
Operation hints	11
Light emitting diodes (LED)	11
Resetting the base station	11
Emergency reset to factory settings	12
Configuring the system	13
The web configurator	13
Network administration	18
IP and VLAN settings	18
Provider and PBX profiles	21
Configuring provider or PBX profiles	21
Mobile devices	28
Mobile devices administration	28
Registering/de-registering handsets	30
Handset Registration Centre	35
Telephony settings	37
General VoIP settings	37
Audio quality	38
Call settings	39
XSI services	41
Online directories	42
Corporate online directories (LDAP)	42
Online directories in XML format	46
Online directories – XSI	47
Central phone book	49
Online services	50
XHTML	50

System settings	53
Web configurator access rights	53
Provisioning and configuration	54
Security	56
Date and time	57
Firmware	58
Save and restore	59
Reboot and reset	60
DECT settings	61
Diagnostics and troubleshooting	63
Status information	63
Base station events	64
Incidents	66
System log and SNMP manager	67
Diagnostics	68
Using a handset connected to an N610 IP PRO base	69
Making calls	69
Accepting calls	70
Conversation with three participants	71
Message indication	72
Using directories	73
Using the network mailbox	74
LDAP directory – configuration example	75
Access to the LDAP server	75
Filters	77
Attributes	80
Display on the handsets	81
Appendix	84
Safety precautions	84
Service (Customer Care)	84
Authorisation	85
Environment	85
Care	86
Contact with liquid	86
Technical data	87
Specifications	87
Index	89

Gigaset DECT IP PRO devices – overview

Gigaset PRO DECT IP devices combine the possibilities of IP telephony with the use of DECT phones. They offer scalable telephone solutions for different company sizes and requirements.

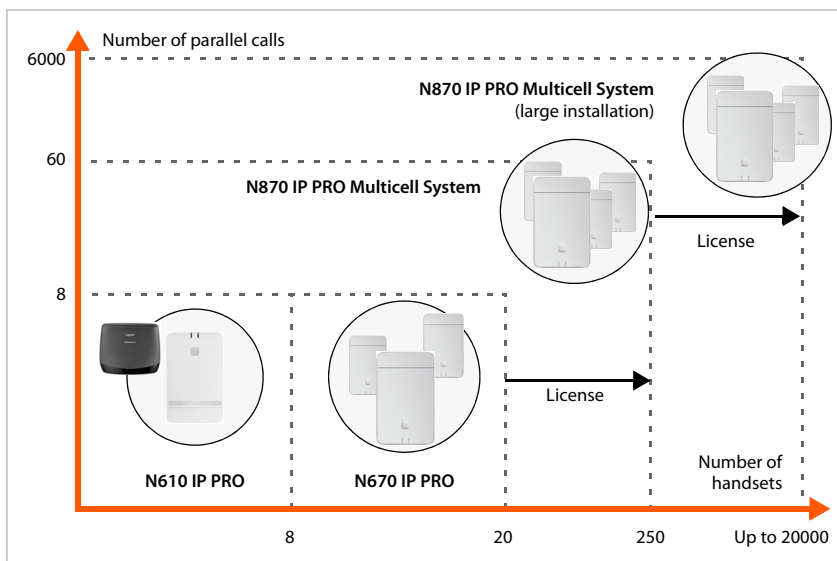

- N610 IP PRO** Single cell, 8 handsets, 8 simultaneous calls
Repeater support for range extension (up to 6)
- N670 IP PRO** Single cell, 20 handsets, 8 simultaneous calls
Possible upgrades:
- to a mini multicell system (3 base stations) for range extension
 - to a device in an N870 IP PRO Multicell System via license key
- N870 IP PRO** Multicell system, 60 bases stations, 250 handsets, 60 simultaneous calls
Possible upgrade to a large system with up to 6000 base stations, 20000 handsets, 6000 simultaneous calls via license key.

N610 IP PRO – Introduction

N610 IP PRO is a DECT base station for connecting to a VoIP PBX.

The following illustration shows the way the N610 IP PRO is embedded in the IP telephone environment:



- **N610 IP PRO**

- Provides cell site DECT functions
- Combines all necessary functions in one device – integrator for central management, DECT manager and base station
- Provides media processing from handset directly towards PBX
- Provides connection channels for the handsets, the number depends on various factors such as the approved bandwidth
- Has an integrated DECT manager providing an application gateway between SIP signalling and DECT signalling as well as handset DECT registration
- Up to six repeaters can be registered to extend the range of the base station's DECT network. The repeaters can only be arranged in a star configuration, not as a chain.



For the time being, repeaters without encryption can be registered (e.g., Gigaset Repeater V1.0). For information on registering repeaters to the base station, visit wiki.gigasetpro.com.

N610 IP PRO – Introduction

- **Handsets (mobile devices)**

- N610 IP PRO can manage up to 8 handsets.
- Eight DECT calls could be made simultaneously via VoIP, including network directory sessions and info centre sessions. For information on handset functions in relation to Gigaset base stations, visit wiki.gigasetpro.com.

Number of parallel calls depending on the bandwidth: → p. 26

Configuring handsets → p. 28

Detailed information about approved Gigaset handsets can be found in the relevant user guide. These are provided on the Internet at wiki.gigasetpro.com.

- **PBX (Private Branch Exchange)**

You need to connect your DECT telephone system to an IP PBX or Provider with VoIP (SIP) connections, e.g.,

- On premise PBX
- Hosted PBX
- Cloud PBX
- VoIP Provider

The PBX

- Establishes the connection to a public telephone network
- Enables central management of telephone connections, directories, network mailboxes

Overview

Front

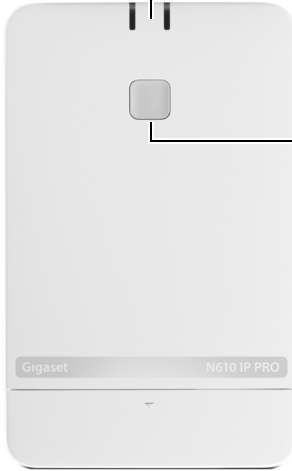

LED displays

Operation status of the device
→ p. 11

Device button

Reset the device → p. 11

Bottom



LAN and power cable slot

Connecting the device → p. 8

Rear



Wall mounting slots

Wall mounting → p. 10

First steps

Package content

- One N610 IP PRO
- Power adapter
- Security leaflet
- Screws and wall plugs for wall mounting

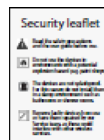

Whenever there are new or improved functions for your Gigaset device, firmware updates are made available for you to download to your DECT base station. If this results in operational changes when using your phone, a new version of this user guide or the necessary amendments will be published on the Internet at

wiki.gigasetpro.com

Select the product to open the relevant product page for your device, where you will find a link to the user guides.

To find out which version of the firmware is currently loaded, see → p. 58 and/or p. 63.

Mounting the device

- The N610 IP PRO is intended for wall mounting (→ p. 10).



- The N610 IP PRO is designed for use in dry rooms with a temperature range of +5°C to +45°C.
- Never expose the N610 IP PRO to heat sources, direct sunlight or other electrical appliances.
- Protect your device from moisture, dust, corrosive liquids and fumes.

Connecting the power supply



Your N610 IP PRO is supplied with sufficient power via PoE (Power over Ethernet) if the device is connected to an Ethernet switch with PoE functionality (PoE class IEEE802.3af). In this case, you do **not** need to connect the device to the mains power supply.



- ▶ Pull down the lower part of the housing and fold it forwards **1**.
- ▶ Connect the power supply cable to the power connector on the base station **2**.
- ▶ Plug in the power supply **3**.

Connecting to the LAN

You can connect the N610 IP PRO to your local network via a router, switch, or hub. A VoIP PBX is required for Internet telephony. This must be accessible via the local network and must have network access (to the Internet and/or the analogue or ISDN telephone network), because base stations do not offer any NAT-traversal support. NAT-traversal support of a PBX or providers might not provide unlimited support for a system with SIP and media traffic transferred via different hosts. Otherwise it will only be possible to make calls within the LAN.

You also need a PC connected to the local network, so that you can configure your telephone system via the web configurator.

For each device to be connected to the local network an Ethernet cable is required.

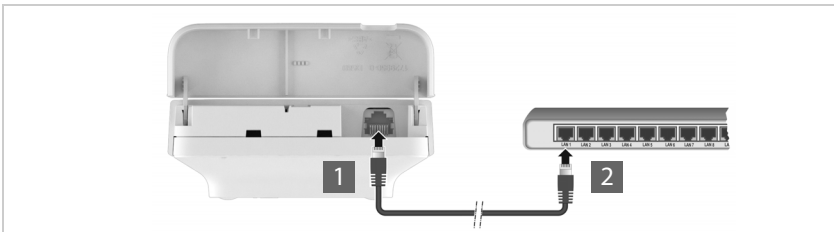

- ▶ Insert a plug from an Ethernet cable into the LAN connection socket at the bottom of the device **1**.

First steps

- ▶ Insert the second Ethernet cable plug into a LAN socket for your local network or on the PoE switch 2.
- ▶ Close the flap.



Data protection notice

Once the device is connected to the Internet, it automatically contacts the Gigaset support server to make it easier for you to configure the devices and to enable communication with Internet services.

For this purpose, the system sends the following information when it is started and then once a day:

- MAC address
- IP address on the LAN/its port numbers
- Device name
- Software version

On the support server, this information is linked to the existing device-specific information:

- System-related/device-specific passwords

Wall mounting

N610 IP PRO is intended for wall mounting. After connecting the LAN cable you can place it to the destined location.

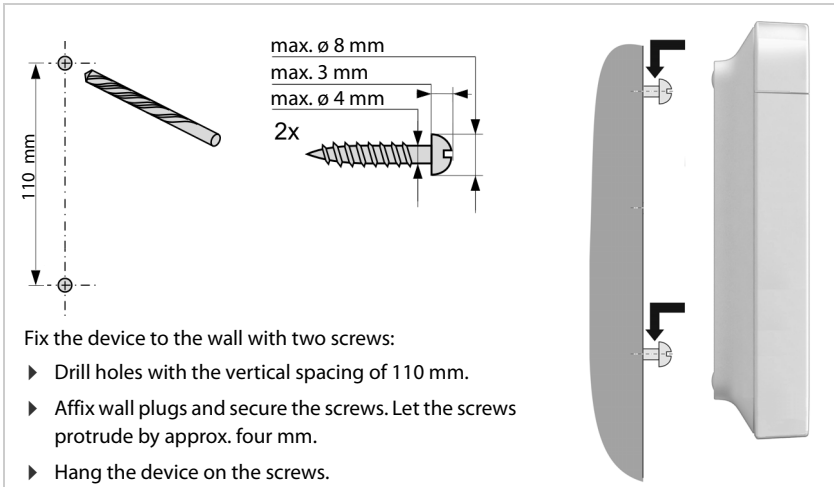

Operation hints

Light emitting diodes (LED)

The LEDs on the front side show different operational states. The LEDs can have three different colours (red, blue, green) or can be off.



LED 1 (left)				LED 2 (right)				Description
0.5 s	0.5 s	0.5 s	0.5 s	0.5 s	0.5 s	0.5 s	0.5 s	
[Grey]				[Grey]				Power off
[Red]				[Red]				Device is booting
[Grey]		[Blue]		[Blue]		[Grey]		Firmware update in progress
[Grey]		[Red]		[Red]		[Grey]		No connection to LAN or no IP address available/assigned
[Green]				[Blue]				DECT ready
[Green]			[Grey]	[Blue]			[Grey]	DECT or RTP traffic
[Green]	[Grey]			[Blue]			[Grey]	DECT or RTP overload



LED status display for base stations can be disabled.

Resetting the base station

You use the device button on the front side to reset the base station.

- ▶ Press the device button for at least 10 seconds until all LEDs switch off. ▶ Release the button ... the device is now in programming mode.
- ▶ Short press the device button until both LED lights blue.
- ▶ Press the device button at least three seconds but less than 10 seconds ... the device is reset and rebooted.



The system is reset to factory setting. This means, that existing configuration and user data will be lost.

Emergency reset to factory settings

When the device is booting

- ▶ Press the device button for at least 10 seconds until all LED switch off ▶ release the button ... the device is now in programming mode.
- ▶ Press the device button until both LED lights blue
- ▶ Press the device button for at least four seconds ... the device is reset and rebooted.

Configuring the system

System settings are made via the web configurator of the N610 IP PRO and cannot be changed using the handsets.

This applies in particular for:

- Registering and de-registering the handset at the telephone system, handset name.
- All settings for the VoIP account used by a handset for calls.
- Configuration of online directories.

Handset-specific settings are preset on your handset. You can change these settings.

This applies, for example, for

- Display settings, such as language, colour, backlight etc.
- Settings relating to ringtones, volume, speaker profiles etc.

Information about this can be found in the user guide for the relevant handset.

The web configurator

Use the web configurator to set up your N610 IP PRO and configure your DECT network.

- Make basic settings for the VoIP connections and register and configure the handsets you wish to use in the DECT network.
- Make additional settings, e.g., meet particular prerequisites for connecting the handsets to a corporate network or adjust the voice quality on VoIP connections.
- Save data required to access specific services on the Internet. These services include access to online directories, as well as synchronising the date/time with a time server.
- Save your DECT network's configuration data as files on your PC and reload these in the event of an error. Upload new firmware, if available, and plan firmware updates at a specific date.

Starting



A standard web browser is installed on the PC/tablet.

The N610 IP PRO and the PC/tablet are directly connected to one another in a local network. The settings of any existing firewall installed on your PC allow the PC/tablet and the N610 IP PRO to communicate with each other.



Depending on your VoIP PBX/VoIP provider, it is possible that you will be unable to change individual settings in the web configurator.

While you are connected to the web configurator, it is blocked to other users. Simultaneous access is not possible.

- ▶ Launch the web browser on your PC/tablet.
 - ▶ Enter gigaset-config.com in the address field of the web browser
- If several Gigaset devices can be reached at this address, a list is displayed ▶ Select device or

Configuring the system

- ▶ Enter the current IP address of the base station in the address field of the web browser (for example: <http://192.168.2.10>).

IP address of the device

If the IP address is assigned dynamically via your local network's DHCP server, you can find the current IP address on the DHCP server in the list of registered DHCP clients. The MAC address can be found on the rear of the device. If necessary, contact the network administrator for your local network.

Your DECT manager's IP address may change occasionally depending on the DHCP server settings (→ p. 18).

Logging into/off the web configurator

Once you have successfully established the connection, the login screen is displayed in the web browser. There are two user roles with different user IDs:

admin has unlimited access to all functions of the web configurator.

user has only limited access to some settings and system information, e.g., handset registration and some system settings. The **user** role must be activated before it can be used (→ p. 53).

- ▶ Enter the user ID in the **Username** text field (**admin/user**).
- ▶ Enter the password in the **Password** text field. Default **admin/user**
- ▶ From the options menu **Language** select the desired language.
- ▶ Click on **Login**.

Logging in the first time

You will be asked to change the default password and to set the appropriate radio frequency band.

- ▶ Enter a new password in the **New password** field and repeat it in the **Repeat password** field
The password must contain:
 - at least one upper-case character
 - at least one number
 - at least one special character
 - from 8 to 74 characters
- ▶ Select the radio frequency band used in your region from the list (→ p. 62).
- ▶ Click on **Set** to save the settings and to open the administrator interface.



If you do not make any entries for a lengthy period (approx. 10 minutes), you are automatically logged off. The next time you try to make an entry or open a web page, the login screen is displayed again. Enter the password again to log back in.

Any entries that you did not save on the telephone system before automatic logoff will be lost.

Logging off

You will find the log off function at the top right of each web page, below the product name.

- ▶ Click on  Logout



The session is automatically terminated after ten minutes of inactivity.

Always use the logout function to end the connection to the web configurator. If, for example, you close the web browser without logging off beforehand, access to the web configurator may be blocked for a few minutes.

Changing language

You can change the language at any time.

- ▶ From the option menu  Language ▼ at the top right of any web page select the desired language.

Licence terms

The login screen provides information on the open source software included in the product.

- ▶ In the lower right corner of the login screen click on **Licence terms**.

Showing/hiding the navigation menu

On each web configurator page a side menu on the left allows you to navigate through the available functions. The menu currently used is unfolded and the currently selected menu entry is coloured orange.

The navigation menu can be displayed permanently or can be hidden in the case the pointer is moved out of the menu area.

- ▶ Use the **Auto-hide menu** check box beneath the menu list to show/hide the menu.



unchecked The navigation menu is shown permanently. (Default)



checked The menu is hidden as soon as you move the pointer out of the menu area. Only the upper menu level symbols are shown on the left.

To re-display the menu: ▶ Move the pointer to the area the menu symbols are shown.

Help function

Parameter description





- ▶ Click on the question mark next to the parameter for which you need information. A popup window is opened displaying a short description for the selected parameter.

Function description for the entire web configurator page

- ▶ Click on the question mark in the upper right corner of the page. The online help is opened in a separate window. It provides information about the functions and tasks that can be performed via this page.

Configuring the system

You have access to the total online help:

- Browse through the online help: ▶ Use the   buttons.
- Open the table of contents: ▶ Click on the  button.
- Open the index to search for specific keywords: ▶ Click on the  button.

Applying/discarding changes

Applying changes

- ▶ Select the **Set** button as soon as you have completed your change on a page ... the new settings are saved and activated in the configuration.



Changes that have not been saved are lost if you move to another web page or the connection to the web configurator is lost, e.g., due to exceeding the time limit (→ p. 14).

Discarding changes

- ▶ Select the **Cancel** button ... changes made on the web page are rejected and the settings that are currently saved in the telephone system configuration are reloaded.

Working with lists

Changing the appearance of the list

Filtering the list:

- ▶ Enter a search item (full field content) in the text field ... only entries containing text matching the search item in any column are shown in the table.



Filtering the list by column content:

- ▶ In the **Search in** option menu select the columns which should be searched for the entered search item ... only entries containing text matching the search item in the selected column are shown in the table.

Sorting the list:

- ▶ Click on the arrows next to the column header to sort the table on the column content in ascending or descending order.

Displaying/ hiding columns:

- ▶ Click on the **View** option menu on the right ▶ Select the columns you want to be displayed in the table ( /  = displayed/hidden).

Names of columns which cannot be hidden are greyed out.

Changing the number of list entries

- ▶ On the right side below the list select the maximum number of entries that should be displayed on a page (10, 25, 50, 100).

Browsing through the list

If there are more list entries than the selected number, you can browse through the whole table page by page. The number of pages is shown below the list. The current page is highlighted.

- ▶ Click on **Previous** or **Next** to scroll through the list page by page.
- ▶ Click on a specific page number, to go to the desired page directly.

Web configurator menu overview

Settings	Network	IP/LAN	→ p. 18
	Provider or PBX profiles		→ p. 21
	Mobile devices	Administration	→ p. 28
		Registration Centre	→ p. 35
	Telephony	VoIP	→ p. 37
		Audio	→ p. 38
		Call settings	→ p. 39
	Online directories	Corporate	→ p. 42
		XML	→ p. 46
		XSI	→ p. 47
		Central phonebook	→ p. 49
	Online services	XHTML	→ p. 50
	System	Web configurator	→ p. 53
		Provisioning and configuration	→ p. 54
		Security	→ p. 56
System log		→ p. 67	
Date and time		→ p. 57	
Firmware		→ p. 58	
Save and restore		→ p. 59	
Reboot and reset		→ p. 60	
DECT		→ p. 61	
Status	Overview	→ p. 63	
	Statistics	Base stations	→ p. 64
		Incidents	→ p. 66



The **user** role has only restricted access to the user interface. If you login as **user**, most of the menus entries are hidden.

Network administration

IP and VLAN settings

This page is used to integrate the device into your company's local network.

It is only available for the user role **admin**.

▶ **Settings** ▶ **Network** ▶ **IP/LAN**



If you change the IP address of the device or an error occurs when you are changing the IP settings, the connection to the web User Interface may be lost.

IP address changed: ▶ Re-establish the connection with the new address.

An error occurred: ▶ Reset the device to the factory settings.

Resetting the base station (→ p. 11)

Device name in the network

▶ Enter a label for the device. It is used to identify the device in network communication.

Address assignment

Network type

▶ Select the IP protocol used in your local network: Currently only **IPv4** is supported.

IP address type

▶ Select **Dynamic**, if your device receives the IP address via a DHCP server.

▶ Select **Static**, if you want to assign a fixed IP address to the device.

If the **Dynamic** setting is selected, all further settings are automatically configured. They are displayed and cannot be changed.

If you have selected **Static** as the address type, you must create the following settings.

IP address

▶ Enter an IP address for your device. This IP address allows your device to be reached by other subscribers in your local network.

The IP address comprises four individual groups of numbers with decimal values from 0 to 255 that are separated by a dot, e.g., 192.168.2.1.

The IP address must be included in the address block used by the router/gateway for the local network. The valid address block is defined by the IP address for the router/gateway and the **Subnet mask**.



The IP address must be unique across the network, which means that it must not be used by another device connected to the router/gateway.

The fixed IP address must not belong to the address block that is reserved for the DHCP server for the router/gateway.

Check the settings on the router or ask your network administrator.

Subnet mask

The Subnet mask specifies how many parts of an IP address the network prefix must comprise. For example, 255.255.255.0 means that the first three parts of an IP address must be the same for all devices in the network, while the last part is specific to each device. In subnet mask 255.255.0.0, only the first two parts are reserved for the network prefix.

- ▶ Enter the subnet mask that is used by your network.

Standard gateway

The Standard gateway is generally the router/gateway of the local network. Your Integrator/DECT manager device requires this information to be able to access the Internet.

- ▶ Enter the local (private) IP address for the standard gateway through which the local network is connected to the Internet (e.g., 192.168.2.1).

Preferred DNS

DNS (Domain Name System) allows you to assign public IP addresses to symbolic names. The DNS server is required to convert the DNS name into the IP address when a connection is being established to a server.

- ▶ Enter the IP address for the preferred DNS server. You can specify the IP address for your router/gateway here. This forwards address requests from the Integrator/DECT manager to its DNS server. There is no default setting for a DNS server.

Alternate DNS

- ▶ Enter the IP address for the alternate DNS server that should be used in situations where the preferred DNS server cannot be reached.

VLAN

Details in this area are only required if you connect your phone system to a local network that is divided into virtual subnetworks (VLAN – Virtual Local Area Network). In a tagged VLAN, data packets are assigned to the individual subnetworks via tags (markings) that consist of a VLAN identifier and the VLAN priority, amongst others.

You will need to save the VLAN identifier and VLAN priority on the phone system configuration. Your VLAN provider will supply you with this data.

VLAN tagging

- ▶ Select the check box next to **VLAN tagging**, if you want the phone system to use VLAN tagging.

VLAN identifier

- ▶ Enter the VLAN identifier that uniquely identifies the subnetwork. Value range: 1–4094.

VLAN priority

The VLAN priority allows voice data transport to take priority, for example.

- ▶ From the option menu select the priority for the phone system data.
Value range: 0–7 (0 = lowest, 7 = highest priority; Default = 6)

Network administration



Ensure that the details in **VLAN identifier** or **VLAN priority** are set correctly. Incorrect settings can cause problems when connecting the device for configuration purposes.

If required, you must carry out a hardware reset via device button (→ p. 11). This means that all settings are lost.

Provider and PBX profiles

You can use up to 20 different VoIP PBX or VoIP provider profiles, e.g.

- your company's VoIP PBX
- and/or public providers from which you have requested VoIP services.

This page allows you to create a list of systems providing VoIP connections and other services for your phones.

This page shows all available VoIP connections.

It is only available for the user role **admin**.

▶ **Settings ▶ Provider or PBX profiles**

Name The name that you have defined for the connection is displayed, or the default name (IP1 - IP20). It can be edited (→ p. 21).

Domain Domain part of the user address. In the case that a connection is not used **Not configured** is displayed.

▶ Use the **Previous/Next** button to change between VoIP connection 1 to 10 and 11 to 20.

Configuring provider and/or PBX profiles

▶ Click on  next to the name of the VoIP connection you want to edit ... the provider/PBX configuration page is opened (→ p. 21).

Configuring provider or PBX profiles

On this page you can edit the data for the selected provider or PBX telephony server profile.

It is only available for the user role **admin**.

Connection name or number

▶ Enter a name for the provider or PBX profile. This name is shown in the Provider/PBX list. To distinguish between different connections it should specify the respective VoIP service provider.

Phone system

System

▶ Select the type of PBX you use for VoIP provisioning from the option menu.

General provider data

Domain

▶ Enter the domain part of the user address (SIP URI). Together with the phone's user name it is used to build the Address Of Record (AOR) or to build a destination out of the dialled number.

Provider and PBX profiles

Examples:

sip.domain.net for john.smith@sip.domain.net
10.100.0.45 for 02871913000@10.100.0.45

Proxy server address

The SIP proxy is your VoIP provider's gateway server and the first SIP server, where the device should send SIP requests and expects to receive requests.

- ▶ Enter the IP address or the (fully qualified) DNS name of your SIP proxy server (max. 74 characters, 0 - 9, a - z, A - Z, -, , , _).

Examples: **10.100.0.45** or **sip.domain.net** or **sipproxy01.domain.net**

Proxy server port

- ▶ Enter the port number of the first SIP server, where the device should send SIP requests and expects to receive requests.

Range: 1-65535; Default: **5060** (for UDP/TCP), **5061** (for TLS)

DNS SRV SIP server redundancy lookup might provide a different server port which is used then.

Registration refresh time

- ▶ Enter the time intervals (in seconds) at which the phone should repeat the registration with the VoIP server (SIP proxy). A request will be sent to establish a session. The repeat is required so that the phone's entry in the tables of the SIP proxy is retained and the phone can therefore be reached. The repeat will be carried out for all enabled VoIP connections.

Values: 1 - 5 digits, > 0; Default: **600** seconds

Transport protocol

- ▶ Select between UDP, TCP and TLS.

UDP (User Datagram Protocol) UDP is a non session-based protocol. UDP does not establish a fixed connection. The data packets ("datagrams") are sent as a broadcast. The recipient is solely responsible for making sure the data is received. The sender is not notified about whether it is received or not.

TCP (Transmission Control Protocol) TCP is a session-based transmission protocol. It sets up, monitors and terminates a connection between sender and recipient for transporting data.

TLS (Transport Layer Security) TLS is a protocol for encrypting data transmissions on the Internet. TLS is a superordinate transport protocol.

Use SIP Security (SIPS)

Only if TLS is selected. SIPS enhances SIP with TLS/SSL encryption. Using SIPS makes it more difficult to listen in on the connection. Data is transmitted encrypted over the internet.

- ▶ Mark/unmark the check box to enable/disable the use of SIPS.

SRTP options

SRTP (Secure Realtime Protocol) is a security profile to ensure confidentiality, integrity, replay protection and message authentication for audio-visual data transmission over IP-based networks.

- ▶ Select which calls should be accepted:

Secure Real Time Protocol Security is activated for voice connections.

Accept non-SRTP calls Insecure calls are accepted even when SRTP is activated.

Deregister detached HS

The SIP account of handsets that are not reachable can be de-registered automatically.

- ▶ Click on **Yes/No** to enable/disable automatic de-registration.

Redundancy settings

Redundancy - DNS query

VoIP providers provide SIP server redundancy for load balancing and service reliability. SIP servers can be identified by DNS using different queries:

A Records just the specified IP addresses and the related port numbers.

SRV + A Finds an available server port for the specified proxy and registration server. DNS SRV allows a client to only have to know what type of service it is looking for instead of the actual server.

Failover server

If **Redundancy - DNS query = A**

In case your provider supports a failover server you can enter the data here.

- ▶ Enable/disable the use of a failover server via the radio boxes next to **Enable registration**.

Registration server

- ▶ Enter the IP address or the (fully qualified) DNS name of the failover registration server.

SIP server port

- ▶ Enter the communication port used on the failover registrar.

Range: 1-65535; Default: **5060** (for UDP/TCP), **5061** (for TLS)

Network data of the service provider

Outbound proxy mode

The N610 IP PRO allows you to configure an outbound proxy. Despite any other SIP protocol rules, if activated (**Always**), the system will always send all outgoing requests towards this outbound proxy. It can be an outbound proxy in the local network provided by the local network provider or in the public network provided by the network/VoIP provider.

- ▶ Specify when the outbound proxy should be used.

Always: All signalling and voice data sent by the system is sent to the outbound proxy.

Never: The outbound proxy is not used.

Provider and PBX profiles

If the further outbound proxy configuration is identical to the proxy and registrar configuration it is useless and will be ignored.



The DHCP option 120 "sip server" sent by a SIP phone would internally override the outbound proxy address and port setting. **Outbound proxy mode** is still and exclusively in the hands of the local device administrator. By setting **Outbound proxy mode** to **Never**, you can prevent any usage of DHCP option 120 by the DECT VoIP phone. To allow for DHCP option 120, you should set **Outbound proxy mode** to **Always**.

Outbound server address

This is the address, where the device should send all SIP requests to and where (in case of successful registration) it expects to receive requests from.

- ▶ Enter the (fully qualified) DNS name or the IP address of your provider's outbound proxy.

Example: **10.100.0.45** or **sip.domain.net** or **sipproxy01.domain.net**

If the **Outbound server address** field is empty, the system behaves independently of the selected mode, as with **Outbound proxy mode = Never**.

Outbound proxy port

This is the port number of the outbound proxy server, where the device should send all SIP requests to (and where it in case of successful registration expects to receive requests from).

- ▶ Enter the communication port used by the outbound proxy.

Range: 1-65535; Default: **5060** (for UDP/TCP), **5061** (for TLS)

Outbound proxy port is empty and **Outbound server address** is a name:

The RFC3263 rules will be used to locate SIP servers and select them for load balancing and redundancy.

Outbound proxy port is a fixed number:

The usage of DNS SRV records according to RFC3263 is blocked.

SIP SUBSCRIBE for Net-AM MWI

If activated a subscription is established for the purpose of receiving notifications about new messages on the network mailbox.

- ▶ Enable/disable SIP subscription via the radio boxes next to **SIP SUBSCRIBE for Net-AM MWI**.

DTMF over VoIP Connections

DTMF signalling (Dual Tone Multi Frequency) is required, for example, for querying and controlling certain network mailboxes via digit codes, for controlling of automatic directory enquiries or for remote operation of the local answering machine.

To send DTMF signals via VoIP, you must define how key codes should be converted into and sent as DTMF signals: as audible information via the speech channel or as a "SIP Info" message.

Ask your VoIP provider which type of DTMF transmission it supports.

Automatic negotiation of DTMF transmission

- ▶ For each call, the phone attempts to set the appropriate DTMF signalling type for the codec currently being negotiated: select **Yes**.

The system will use the transmission method matching best the received capabilities from the peer based on the following priority order:

- send via RFC2833, if the PT (Payload Type) for the telephone event is provided by the peer
 - send via SIP INFO application/dtmf-relay, if SIP INFO method is supported by the peer
 - send in-band audio
- ▶ No automatic attempts to set DTMF transmission type: select **No** (DTMF transmission type is **Audio** by default).

Send settings of DTMF transmission

- ▶ Make the required settings for sending DTMF signals:

Audio or RFC 2833 DTMF signals are to be transmitted acoustically (in voice packets).

SIP Info DTMF signals are to be transmitted as code.

Connection ringtones

Different ringtones are possible for internal, external, group, door, emergency and optional calls.

Prerequisite: The provider/platform sends the correct information via the Alert-Info field in the SIP header.

The user can select different ringtones for specific calls at the handset. You can here define which different ringtones are allowed to be set by the user.

- ▶ In the **Name** field enter the name for the menu entry that should be shown in the handset menu.

Note: Internal calls cannot be changed.

- ▶ The **Alert-Info pattern** field contains the Info-Alert definition that must be contained in the SIP header to identify the appropriate call type.

Field is empty: The entry is not shown in the handset menu.

Settings for codecs

The voice quality of VoIP calls is mainly determined by the codec used for the transmission and the available bandwidth of your network connection. A "better" codec (better voice quality) means more data needs to be transferred, i.e. it requires a network connection with a larger bandwidth. You can change the voice quality by selecting the voice codecs your phone is to use, and specifying the order in which the codecs are to be suggested when a VoIP connection is established. Default settings for the codecs used are stored in your phone; one setting optimised for low bandwidths and one for high bandwidths.

Both parties involved in a phone connection (caller/sender and recipient) must use the same voice codec. The voice codec is negotiated between the sender and the recipient when establishing a connection.

Active codecs / Available codecs

The following voice codecs are supported:

- G.722** Outstanding voice quality. The G.722 wideband voice codec works at the same bit rate as PCMA/PCMU (64 kbit/s per voice connection) but at a higher sampling rate (16 kHz). To enable wideband connections via G.722 you have to activate the codec explicitly on the **Telephony – VoIP** page (→ p. 38)
- PCMA/PCMU** (Pulse Code Modulation) Excellent voice quality (comparable with ISDN). The required bandwidth is 64 kbit/s per voice connection.
 PCMA (G.711 a law): Used in Europe and most countries outside of USA.
 PCMU (G.711 μ law): Used in USA.
- G.729A** Average voice quality. The necessary bandwidth is less than or equal to 8 kbit/s per voice connection.

Activate/deactivate a codec:

- ▶ Select the required codec from the **Available codecs/Active codecs** list and click on ← / →.

Define the sequence in which the codecs should be used:

- ▶ In the **Active codecs** list select the required codec and click on ↑ / ↓ to move it up/down.



Selection of codecs G.722 and G.729 influence the system capacity in direction to lower amount of parallel calls per base station.

Number of parallel calls per base station depending on bandwidth

Codecs enabled	Number of calls
G729 and G711	8
G722 and G729 and G711	5

RTP Packetisation Time (ptime)

Length of time in milliseconds represented by the audio data in one packet.

- ▶ Select the size of RTP packets to send. Select between 10 / 20 / 30 ms.

Signalling options for 'Hold' in Session Description Protocol (SDP)

Call hold means that a user requests to put an active call on hold. The holding part sends a re-INVITE request to the held client with an SDP offer (Session Description Protocol). This SDP offer contains the attribute line a=inactive or a=sendonly.

- ▶ Select which attribute should be sent in the SDP offer:

inactive The SIP endpoint would neither send nor receive data.

sendonly The SIP endpoint would only send and not receive data.

Hold towards Transfer-Target

The device enables call transfer after consultation or without consultation.

- ▶ Define, whether a consultation call with transfer target is put on-hold prior to the execution of the call transfer (**Yes**) or not (**No**).

Display of caller information

- ▶ From the **Calling Party (User Part)** option menu select which information is allowed to be transferred to the receiving part within the SIP header. Which information is actually transferred is determined by the provider.

Service Codes

Service codes are key sequences provided by the provider or PBX in order to activate/deactivate specific functions on the handset. You can set the adequate service codes for activating/deactivating CCBS and CCNR.

CCBS (Completion of Call to busy Subscriber) Ringback if busy

CCNR (Completion of Calls on No Reply) Ringback if no answer

- ▶ In the text fields **Call Completion on (CCBS, CCNR)/Call Completion off (CCBS, CCNR)** enter the key sequence for activating/deactivating CCBS and CCNR.

CSTA

Computer Supported Telecommunications Applications is a standard for the interaction between a computer and a PBX, independently from the manufacturer. If your PBX provides CSTA applications to be used by the registered handsets you have to activate the standard here. Account data for handset access can be configured for each handset (→ p. 34).

- ▶ Define, whether CSTA should be activated (**Yes**) or not (**No**).

Deleting the profile

- ▶ Click on **Delete** to delete the profile ▶ Confirm the operation with **Yes**.

Mobile devices

You can use the web configurator to register all handsets at the DECT network and for a VoIP connection. Use the add function of the **Administration** page to register single handsets or use the **Registration Centre** to register groups of handsets in one process.

You can edit the settings for handsets, deactivate or delete them and make further settings e.g., for using directories and network services.









Mobile devices administration

This page allows you to register single handsets to the phone system.

It is available for both the user role **admin** and **user**.

► Settings ► Mobile devices ► Administration

The currently registered handsets and place holders for handsets that could be registered are listed on the page with the following information:

IPUI	International Portable User Identity used in order to uniquely identify a handset within the DECT network.										
Username	User name from the SIP account that is assigned to the handset, usually the phone number. The name is displayed on the handsets when they are in idle status. The setting can be changed.										
Display name	Display name from the SIP account that is assigned to the handset. The display name indicates the originator of the request when the user initiates a call.										
Location	Name of the DECT manager the handset belongs to. The symbol  indicates that the DECT manager is currently disconnected.										
DECT	DECT registration state of the handset: <table> <thead> <tr> <th>Status</th> <th>Meaning</th> </tr> </thead> <tbody> <tr> <td>To register</td> <td>System ready to register a handset</td> </tr> <tr> <td>Not registered</td> <td>Registration not possible</td> </tr> <tr> <td>Registering</td> <td>Registration in progress</td> </tr> <tr> <td>Registered</td> <td>Handset is registered</td> </tr> </tbody> </table> <p>The symbol  indicates that the handset is currently not reachable (powered down, battery removed, out of range, broken, stolen, ...)</p>	Status	Meaning	To register	System ready to register a handset	Not registered	Registration not possible	Registering	Registration in progress	Registered	Handset is registered
Status	Meaning										
To register	System ready to register a handset										
Not registered	Registration not possible										
Registering	Registration in progress										
Registered	Handset is registered										
SIP	Indicates, if the handset has a working VoIP connection. <table> <tbody> <tr> <td></td> <td>A VoIP connection is registered for the handset and a connection has been established successfully.</td> </tr> <tr> <td></td> <td>There is no VoIP connection configured or it is not possible to establish a connection to the configured VoIP provider.</td> </tr> </tbody> </table>		A VoIP connection is registered for the handset and a connection has been established successfully.		There is no VoIP connection configured or it is not possible to establish a connection to the configured VoIP provider.						
	A VoIP connection is registered for the handset and a connection has been established successfully.										
	There is no VoIP connection configured or it is not possible to establish a connection to the configured VoIP provider.										

DND	Indicates, if DND (Do not Disturb) is activated for the handset.
Type	Model designation of the handset.
FW	Current firmware version of the handset.
PIN	Authentication code defined for handset registration.

Actions

Adding a handset to the list

- ▶ Click on **Add** ... the mobile devices data page is opened (→ p. 30).

Copying handset data for another configuration

- ▶ Select the check box next to the handset whose settings you want to copy. ▶ Click on **Copy** ... the mobile devices data page is opened (→ p. 30). The settings of the selected mobile device except personal data are taken over for the new handset configuration.

Replace a mobile device for a user by another one

- ▶ Select the check box next to the handset of a user who should get another handset. ▶ Click on **Replace** ... the mobile devices data page is opened (→ p. 30). The old mobile device will be set to **To deregister**. Personal provider data will be removed. User-specific data remain preserved. You will be prompted register a new mobile device.

Deleting a handset from the list

- ▶ Select the check box next to the handset you want to delete. Multiple choice is possible. ▶ Click on **Delete** ▶ Confirm with **Yes** ... all selected handsets are deleted.

Exporting/Importing the handset configuration

You can export the handset configuration and import it into another device.

Exporting:

- ▶ Select all handsets you want to be transferred via the check mark next to the IPUI.
- ▶ Click on **Export** ▶ Select the location where the export file should be stored using the system file selection dialogue.

Importing:

- ▶ Click on **Import** ▶ Select the previously exported handset configuration file from your computer's file system.

Editing the data of a handset

- ▶ Click on  next to the handset you want to edit ... the mobile devices data page is opened (→ p. 30).

Setting the name to be displayed in the idle display

By default, the **Username** is displayed in the handset's idle display. You can determine that the **Display name** should be used instead.

Registering/de-registering handsets

The page allows you to register a handset with the DECT network or to prepare the registration of numerous handsets via the Registration Center. You can assign a VoIP account, enable online directories, and make further settings for the handsets.

It is available for both the user role **admin** and **user**.



Registration/de-registration in this context refers to the handset's relationship to the DECT network but not to SIP registration.

Registering handsets

- ▶ Enter an IPUI, if you want to restrict the registration to a specific handset.
- ▶ Enter an authentication code manually or generate it via the **Generate random PIN** button.
- ▶ Enter all configuration data for the handset.
- ▶ Click on **Register now**.

The handset with the matching IPUI is now allowed to register. If no IPUI is defined all handsets within range can register.



The system stays in registration mode as long as it is defined via the **Registration duration** parameter on the **Registration Centre** page (→ p. 35). Default: 3 min.

On the handset

- ▶ Start the registration procedure as described in the appropriate documentation. ▶ When prompted, enter the PIN that has been entered or generated.

Registering a set of handsets

You can register a set of handsets without restarting the registration mode. Prepare registration for new mobile devices as follows:

- ▶ Enter the actual IPUI and maybe an individual PIN
- or
- ▶ Use wildcards as IPUI (0_1, 0_2, 0_3 ...) and preferably the same PIN for all handsets.
 - ▶ Set the **RegStatus** of the handsets to **To register**
 - ▶ Open the registration window for a desired time and register all handsets without further Web UI interaction via the **Registration Centre** (→ p. 35).

Parameters

IPUI

(International Portable User Identity) Unique identifier of a handset within the DECT network. If you edit an existing handset registration entry, the IPUI is shown and cannot be changed.

For a new entry:

- ▶ Enter the IPUI of the handset that should be allowed to register with the DECT network in the text field.

If the field is empty, any handset will be allowed to register.

RegStatus

DECT registration status of the handset entry. The option menu allows you to change the status.

Status	Meaning / possible action to change the status
To register	The system is ready to register a handset using these settings. ▶ Select Not registered to disable registration.
Not registered	No registration possible. ▶ Select To register to allow a handset to register using these settings.
In registration	Registration in progress. ▶ Select Not registered to cancel the running registration process.
Registered	The handset is registered. ▶ Select To deregister to de-register the handset.

Authentication Code (PIN)

This PIN must be used on the handset to register with the DECT network.

- ▶ Enter a PIN in the text field. Value: 4 digits

or

- ▶ Click on **Generate random PIN** ... a four-digit PIN is generated and shown in the text field.

De-registering handsets

- ▶ In the handset list click on  next to the handset you want to de-register. The status is **Registered**.
- ▶ From the **RegStatus** option menu select **To deregister**. ▶ Click on **Set** ... the handset is de-registered.

DECT de-registration successful: The handset is deleted from the **Mobile devices** list.

DECT de-registration not successful: The handset stays in the **Mobile devices** list with status **To deregister**.

Settings for the handset

When registering a handset you can define important settings and assign functions at the same time.

Personal provider data

Configure the VoIP account for the handset. If the handset is successfully registered,  will be shown in the **SIP** column in the **Mobile devices** list.

 The VoIP/PBX account must be set-up beforehand (→ p. 21).

Mobile devices

VoIP provider

- ▶ Choose a configured VoIP PBX/provider from the option menu.
The connection must be configured on the **Provider or PBX profiles** page (→ p. 21).
- ▶ Enter the access data for the VoIP account in the relevant fields. These fields may vary depending on the PBX/provider profile.

Authentication name

- ▶ Specify the SIP authentication (HTTP digest) name. The **Authentication name** acts as access ID when registering with the SIP proxy/registrar server. It is usually identical to the phone number for the VoIP account. Value: max. 74 characters

Authentication password

- ▶ Enter the password for SIP authentication (HTTP digest). The phone needs the password when registering with the SIP proxy/registrar server. Value: max. 74 characters

Username

- ▶ Enter the caller ID for the VoIP provider account. It is usually identical to the phone number for the VoIP account. Value: max. 74 characters

Display name

The display name is used for presentation of the caller's name. In rare cases SIP networks check the display name for any local policy of the SIP network.

Usually, the display name is optional.

- ▶ Enter any name that should be shown for the caller on the other participant's display.
Value: max. 74 characters

If **Display name** is empty, the **Username** or the phone number will be used.

Online directories

The user can call up various directories using the handset control or INT key.

Directory for direct access

The user can open a directory via the handset directory key (bottom of the control key). By default, **short** pressing the directory key opens the list of online directories, **long** pressing opens the local directory of the handset.

- ▶ Choose which directory should be called up by short pressing the directory key.

Online directories A list of online directories is opened by short pressing. Long pressing opens the local directory.

Local directory The local directory is opened by short pressing. Long pressing opens the online directories.

Directory for INT key

If any online directory is available and configured the user can open it by pressing the INT key (left on the handset's control key).

- ▶ Choose from the list which directory is opened with the INT key.

Automatic look-up

- ▶ Select an online directory from the list for **Automatic look-up** or deactivate this option. When there is an incoming call, the caller's name is read from this directory and shown in the display (the availability of this function depends on the online directory provider).

LDAP authentication

Up to 10 directories in LDAP format can be provided by the phone system. The access to a corporate directory can be provided individually for specific handsets.

Selected LDAP book

- ▶ Select the LDAP directory to be provided on the handset from the option menu.



At least one LDAP directory must have been set-up.

Show other LDAP servers

- ▶ Select **Yes** if directories of other LDAP servers should be allowed to be shown.

LDAP authorisation type

- ▶ Select how the user authentication should be performed:

Global Credentials are set for all handsets during the LDAP directory set-up.

User Individual credentials are used.

- ▶ Enter **Username** and **Password** in the appropriate text fields.

SIP The credentials for the user's SIP account are used (**Authentication name** and **Authentication password**).

Network mailbox configuration

If a network mailbox is available for the VoIP account assigned to the handset, you have to activate this function.

- ▶ Enter the **Call number or SIP name (URI)** for the network mailbox.
- ▶ Activate the function via the check box.

Group pick-up

Group pick-up enables a user to accept a call for another subscriber, e.g., a pick-up group. Users belonging to the same call pick-up group can accept all calls for the group. A pick-up group must be established during SIP account registration. The call number or the SIP URI of a pick-up group can be assigned to the mobile device.

- ▶ Enter the **Call number or SIP name (URI)** of the pick-up group.
- ▶ Activate the function via the check box.

Mobile devices

Call manager

- ▶ From the **Accept calls directly via Call Manager** option menu select, whether calls that are initialised by a PBX call manager are to be accepted directly:

via Headset	To accept the call the handset automatically activates the connected headset.
via Handsfree	To accept the call the handset automatically activates the speaker phone function.
No	The call is not accepted automatically at all.



Direct call acceptance requires a secured signalling to the PBX (TLS).

Accepting calls via a Call Manager has no impact on the DECT system performance, because it is handled on SIP level.

Missed calls and alarms

You can define if missed and accepted calls should be counted and if new messages of specific types should be indicated via the MWI LED on the handset's message key.

- ▶ Select **Yes/No** next to **Missed calls count/Accepted calls count**, to activate/deactivate the call counter for missed and accepted calls. The information is displayed in the handset's call lists, missed calls are also shown on the handset's idle display.
- ▶ Select **Yes/No** next to the message type (missed calls, missed alarms, new message on the network mailbox), to activate/deactivate the MWI LED for the message type.

If **Yes** is selected, the message key will flash, if a new message of the selected types is received.

CSTA

CSTA (Computer Supported Telecommunications Applications) is a standard for the interaction between computer and PBX, independently from the manufacturer. If the provided CSTA applications require individual access control you can enter the access data for the handset here.



CSTA must be provided by your PBX and must be activated in the provider/PBX profile (→ p. 27)

Username

- ▶ Enter the user name for the handset's access to CSTA applications.

Authentication name

- ▶ Specify the authentication name for the handset's access to CSTA applications.

Authentication password

- ▶ Enter the password for the handset's access to CSTA applications.

Broadsoft XSI services

If BroadSoft XSI services should be provided to the user on the handset, enter the credentials.



XSI services must be activated (→ p. 41).

Use SIP credentials

If activated, the credentials for the user's SIP account (**Authentication name** and **Authentication password**) are used.

Alternatively, define the following credentials.

Username

- ▶ Enter a user name for the user access to the menu (max. 22 characters).

Password

- ▶ Enter a password for the user access to the menu (max. 8 characters).

Feature key synchronisation

This option permits the users to use keys on their phones to handle Do Not Disturb and Call Forwarding. If activated, the phones synchronise with the BroadWorks Application server on the status of these features.

- ▶ Select **Yes/No**, to activate/deactivate key synchronisation with the BroadWorks Application server.

Handset Registration Centre

The registration centre allows you to register groups of handsets in one registration process. All handsets which are listed in the mobile devices list and have the registration status **To register** or **Registering** can be registered together.

It is available for both the user role **admin** and **user**.

- ▶ **Settings ▶ Mobile devices ▶ Registration Centre**

The page shows the number of mobile devices in registration status **To register**, **Registering** and the total number of entries in the mobile devices list, including those in registration status **Registered** and **Not registered**.

Registering handsets time-controlled

Shows the current system time. Time settings: → p. 57

- ▶ In the **Registration start time** field enter the time when the next registration process should be started. Format: YYYY-MM-DD HH:mm.
- ▶ Click on **Start now**. . . the DECT manager starts a registration process at the given time. If no time is set, the DECT manager will start registration at once.

Setting the registration duration

- ▶ In the **Registration duration** fields determine how long (days, hours, minutes and seconds) the DECT manager should stay in registration mode. Default: 3 min.

Closing the window and resetting the timers

- ▶ Click on **Close** . . . the registration window is closed, the time settings are reset.

Mobile devices



When the first handset tries to register, the base closes the registration window and finalises the registration within a very few seconds. During this time any second handset registration attempt would be rejected. When the first handset is fully registered the base re-opens the registration window as long as defined with the **Registration start time** and **Registration duration** parameters.

If all handsets try to register in parallel, a lot of them will enter the base one by one and so will be successfully registered, but others might enter while another registration is not yet completed and so they will be rejected.

Single handsets that are rejected have to be registered by a new registration procedure or manually.

Telephony settings

General VoIP settings

This page allows you to make some general settings for the VoIP connections. It is only available for the user role **admin**.

- ▶ Settings ▶ Telephony ▶ VoIP

SIP port

- ▶ Enter the SIP port used for VoIP connections.

Range: 1-65535; Default: 5060

Secure SIP port

- ▶ Enter the SIP port used for secure VoIP connections (TLS).

Range: 1-65535; Default: 5061

SIP timer T1

- ▶ Enter the estimated round trip time of an IP packet between a SIP client and a SIP server (the time it takes between sending out the request to the point of getting a response).

Default: 500 ms

SIP session timer

- ▶ Defines a session expiry interval: If the session isn't refreshed within the interval, the session is released. Session refresh is started after half of the interval by a re-INVITE message, which the peer side has to confirm to get the session refreshed.

Values: max. 4 digits, min. 90 sec; Default: 1800 sec

Failed registration retry timer

- ▶ Specify after how many seconds the phone should attempt to re-register when the initial registration has failed.

Values: max. 4 digits, min. 10 sec; Default: 300 sec

Subscription timer

- ▶ Defines the expiration time (in seconds) of a subscription. In order to keep subscriptions effective, subscribers need to refresh subscriptions on a periodic basis.

Default: 1800 s

PRACK

- ▶ (Provisional Response Acknowledgement) SIP provisional responses do not have an acknowledgement system so they are not reliable. The PRACK method guarantees a reliable and ordered delivery of provisional responses in SIP.

Security settings

The phone system supports the establishment of secure voice connections over the internet via TLS certificates. Thereby, public and private keys are used to encrypt and decrypt the messages that are exchanged between SIP entities. The public key is contained within the certificate of an IP entity and is available for everyone. The private key is kept secret and is never revealed to anyone. The server certificate and the private key must be uploaded to the base stations.

- ▶ Click on **Browse...** and choose the file containing the certificate or the private key from the file system of your computer or network ▶ click on **Upload** ... the file is uploaded and shown in the appropriate list.

SIP security password

- ▶ If your private key is protected by a password, enter it here.

Quality of Service (QoS)

The voice quality depends on the priority of the voice data in the IP network. Prioritising the VoIP data packets is done using the QoS protocol DiffServ (Differentiated Services). DiffServ defines a number of classes for the quality of service and, within these classes, various priority levels for which specific prioritisation procedures are defined.

You can specify different QoS values for SIP and RTP packets. SIP packets contain the signalling data, while RTP (Real-time Transport Protocol) is used for the voice transfer.

- ▶ Enter your chosen QoS values in the **SIP ToS / DiffServ** and **RTP ToS / DiffServ** fields. Value range: 0 - 63.

Common values for VoIP (default setting):

SIP	34	High service class for fast switching of the data flow (Expedited Flow)
RTP	46	Highest service class for fast forwarding of data packets (Expedited Forwarding)



Do not change these values without consulting your network operator first. A higher value does not necessarily mean a higher priority. The value determines the service class, not the priority. The prioritisation procedure used in each case meets the requirements of this class and is not necessarily suitable for transferring voice data.

Audio quality

The phone system allows the user to make calls with excellent voice quality using the wideband codec G.722. One base station enables a maximum of five wideband calls.

The page allows you to enable/disable the use of the wideband codec G.722 for the telephone system.

It is only available for the user role **admin**.

- ▶ **Settings** ▶ **Telephony** ▶ **Audio**
- ▶ Mark/unmark the check box to enable/disable wideband calls
- ▶ Click on **Set** to save the settings of this page.



To allow users to make wideband calls, the codec G.722 must have been activated for the provider profile that is used for the connection (→ p. 26).

Call settings

On this page you can make advanced settings for VoIP connections. It is only available for the user role **admin**.

- ▶ Settings ▶ Telephony ▶ Call settings

Call transfer

Participants can transfer a call to another participant as long as the PBX/provider supports this function. The call is transferred using the handset menu (via the display key) or using the R key. You can expand or change the settings for call transfer.

Call transfer via R key

Activated: Users can connect two external callers with each other by pressing the R key. The connections with both parties are terminated.

Transfer call by on-hook

Activated: The two participants are connected with one another when the user presses the end call key. The intermediary's connections with the participants are terminated.

Determine target address

- ▶ Select how the transfer target address (Refer-To URI) is to be derived:

- From transfer target's AOR (Address of Record)**

- From transfer target's transport address (Contact URI)**

Most common PBX platforms show good results by using the AOR as transfer target address.

In case there are problems with transfer especially via transparent proxies, rather than call switching PBX, it might be worthwhile to test with transfer target address derived from transfer target's transport address.

Access Code

You may have to enter an access code for external calls (external prefixes e.g., "0"). You can save this access code in configuration. These settings apply to all registered handsets.

- ▶ Enter an access code in the **Access Code** text field. Value: max. 3 digits (0 – 9, *, R, #, P)
- ▶ Select when the phone numbers should be automatically prefixed with the digits, e.g. when dialling from a call list or a directory.

Area Codes

If you use VoIP to make a call to the fixed line, you may also have to dial the area code for local calls (depending on the provider).

You can set your telephone system so that the access code is automatically predialled when any VoIP call is made in the same local area, and also for national long-distance calls. This means that the access code is set before all phone numbers that do not start with 0 – even when dialling numbers from the directory and other lists.

You can change these settings if required.

Country

- ▶ From the option menu select the country or region where your telephone system is to be used ... the international and national prefix is then entered in the **Prefix** and **Area code** fields.

International settings

Prefix Prefix of the international area code. Value: max. 4 digits, 0-9

Area code International area code. Value: max. 4 digits, 0-9

Example "Great Britain": **Prefix** = 00, **Area code** = 44

Local settings

Prefix Prefix of the local area code. Value: max. 4 digits, 0 - 9. These digits are placed in front of the local area code for national long-distance calls.

Area code Local area code for your town/city (depending on country/provider). Value: max. 8 digits, 0-9

Example "London": **Prefix** = 0, **Area code** = 207

Tone Selection

Tones (e.g., dialling tone, ring tone, busy tone or call waiting tone) vary from one country or region to another. You can choose from various tone groups for your telephone system.

Tone scheme

- ▶ Select the country or region whose ring tones are to be used for your phone from the option menu.

XSI services

BroadSoft XSI (Xtended Service Interface) allows remote applications to integrate with BroadSoft services to perform telephony-related actions and to be notified about telephony events. The phone system enables the use of XSI services to provide the user with XSI directories and call lists.

If you want to use XSI services, you need to enable the services and enter the XSI server address on this page.

It is only available for the user role **admin**.

▶ **Settings ▶ Telephony ▶ XSI Services**

Server address

▶ Enter the URL of the XSI server in the text field.

Enable XSI directories

▶ Mark the check box, if you want to use XSI directories. Specific XSI directories must be set up as online directory on the XSI page (→ p. 47).

Enable XSI call logs

▶ Mark the check box, if you want to use XSI call logs.

Online directories

N610 IP PRO allows you to set up up to ten corporate directories in LDAP format, a public and a corporate directory in XML format, different XSI directories, as well as a central directory and make them available to the registered handsets.

Use the handset settings (→ p. 31) to specify which keys are to call up the directories.

Corporate online directories (LDAP)

You can set up up to ten corporate directories in LDAP format for the phone system and make one of them available to the registered handsets. If you wish to use a company directory on the telephone system, you must activate it on the Web configurator.

The page lists the available LDAP directories.

It is only available for the user role **admin**.

► **Settings** ► **Online directories** ► **Corporate**

Name The name that you have defined for the directory is displayed, or the default name (LDAP1 - LDAP10). It can be edited (→ p. 42).

Server url If the directory is configured, the server URL is displayed.

Activation status Indicates if the directory is activated or not.



The directory is activated.



The directory is not activated.

Configuring LDAP directories

► Click on  next to the name of the LDAP directory you want to edit ... the LDAP configuration page is opened (→ p. 42).



Detailed information about LDAP configuration can be found at wiki.gigasetpro.com

Configuring an LDAP directory

On this page you can edit the data for the selected LDAP directory.

It is only available for the user role **admin**.

Access to the LDAP data server

The directory is provided via an LDAP server. You need the server address, the server port and the access data for the directory that you wish to use.

- Enter a name in the **Directory name** field (max. 20 characters). This is the name under which the directory will be displayed on the handsets.
- Mark the **Enable directory** option, so that the directory is displayed on the telephones.

Server address / Server port

- ▶ Enter the URL of the LDAP server and the port the LDAP server expects database requests (Default: 389)

LDAP Search base (BaseDN)

- ▶ The LDAP database is hierarchical in design. With the **LDAP Search base (BaseDN)** parameter, stipulate in which area the search should begin.
Default: 0, the search starts at the upper area of the LDAP database.

User access data

If you want to define access data that have to be used by all users:

- ▶ Enter the access data for the LDAP directory in the **Username** and **Password** fields (max. 254 characters each).

If you want to use individual access data for each handset, the access data is to be set during the handset configuration (→ p. 33).

Secure LDAP

By default, LDAP traffic between the phone system and the LDAP directory server is handled via an insecure connection. You can encrypt traffic by enabling secure LDAP. This is accomplished by installing a CA certificate signed by the secure LDAP server onto the system. (→ p. 56)

- ▶ Select the security protocol **SSL/TLS** or **STARTTLS** to be used for encryption or **None** to dispense with encryption.

Settings for searching the LDAP database and displaying the result**Enable list mode**

- ▶ Define what should be initially shown, when the user opens the LDAP directory.

Activated: A list of all entries of the LDAP directory is shown.

Not activated: An editor is opened first that allows the user to select a specific search area within the LDAP database and thereby to reduce the number of entries.

Filters

Using the filters, you can define criteria against which specific entries can be searched in the LDAP database. One filter consists of one or more search criteria. A search criterion contains the query for an LDAP attribute.

Example: sn=%

The **sn** attribute stands for surname. The percent sign (%) is a place holder for the user entry.

Rules for defining filters:

- Multiple criteria can be connected using logical AND (&) and/or OR (!) operators.
- The logical operators "&" and "!" are placed before the search criteria.
- The search criterion must be placed in brackets and the whole expression must be terminated with a bracket again.
- AND and OR operations can be combined.

Online directories

Examples:

AND operation: (& (givenName=%) (mail=%))

Searches for entries in which the first name **and** mail address begin with the characters entered by the user.

OR operation: (| (displayName=%) (sn=%))

Searches for entries in which the display name **or** surname begins with the characters entered by the user.

Combined operation: (|(& (displayName=%) (mail=%))(& (sn=%) (mail=%)))

Searches for entries in which the display name **and** mail address **or** the surname **and** mail address begin with the characters entered by the user.

Information on attributes → p. 45

Name filter

The name filter decides which attribute is used for the search.

Example:

(displayName=%). The percent sign (%) is replaced by the name or part of the name entered by the user.

If a user enters the letter "A", for example, all entries in which the attribute **displayName** begins with "A" are searched for in the LDAP database. If the user then enters a "b", entries are searched in which the **displayName** begins with "Ab".

Number filter

The number filter stipulates the criteria for the automatic completion of telephone numbers.

Example:

((telephoneNumber=%)(mobile=%)). The percent sign (%) is then replaced by the part of the telephone number entered by the user.

When dialling, if a user enters the numbers "123", for example, all telephone numbers that begin with "123" are searched for in the LDAP database. The telephone number is completed with the addition of information from the database.

Additional filters

You can set two additional filters that will be offered to the user in order to specify the search more detailed.

- ▶ In the additional name fields enter the attribute name.
- ▶ In the corresponding value fields enter the attribute values.

Example:

Additional filter #1 name	City
Additional filter #1 value	((l=%))
Additional filter #2 name	Street
Additional filter #2 value	((street=%))

In addition to the fields defined in the **Name filter** parameter, the **City** and the **Street** fields are provided to the user. The user input for **City** is passed to the LDAP server in the **l** attribute, the user input for **Street** is passed in the **street** attribute.

Display format

In the **Display format** field you can stipulate how the search result is to be displayed on the handset.

- ▶ Enter combinations of different name and number attributes and special characters. You can select common formats from the attributes that are listed in the **Configuration of directory items** section of the page.

For the attribute values to be shown for the required attribute, the attribute name must be preceded by a percent sign (%).

Example:

Data of an directory entry on the LDAP server:

displayName	Peter Black	telephoneNumber	0891234567890
givenName	Peter	mobile	012398765432
sn	Black		
...			

Attribute definition in the Web configurator:

Display format %sn, %givenName; %telephoneNumber/%mobile

The entry is shown on the handset as follows:

Black, Peter; 0891234567890/012398765432

Max. number of search results

- ▶ Enter the maximum number of search results that is to be returned by one search operation.

Attributes

A range of attributes are defined in the LDAP database for a directory entry, e.g. surname, first name, telephone number, address, company, etc. The quantity of all attributes which can be saved in one entry is stored in the relevant LDAP server scheme. In order to be able to access attributes or define search filters, you must know the attributes and their designation in the LDAP server. The majority of attribute designations are standardised, however specific attributes can also be defined.

- ▶ For each field of a directory entry that should be displayed on the handsets enter the name of the corresponding LDAP attribute. Multiple attributes can be separated by commas.

Examples:

Field of a directory entry	Attribute name in the LDAP database
First name	givenName
Surname	sn, cn, displayName
Phone (home)	homePhone, telephoneNumber
Phone (office)	telephoneNumber
Phone (mobile)	mobile
E-mail	mail
Fax	facsimileTelephoneNumber
Company	company, o, ou

Online directories

Field of a directory entry	Attribute name in the LDAP database
Street	street
City	l, postalAddress
Zip	postalCode
Country	friendlyCountryName, c
Additional attribute	user-defined

- ▶ Mark the check box **Additional attribute can be dialled**, if an additional attribute is defined and it is a phone number.

A detailed configuration example can be found in section "LDAP directory – configuration example" → p. 75

LDAP configuration with Windows Active Directory server

Active Directory Domain Services (AD DS) is the directory service for Windows server. In a multi-domain AD DS forest (container within an Active Directory configuration containing domains, users, hosts and group policy) the Global Catalog is a distributed data repository that contains a searchable, partial representation of every object in every domain. The global catalog is stored on domain controllers that have been designated as global catalog servers and is distributed through multi-master replication. Searches that are directed to the global catalog are faster, because they do not involve referrals to different domain controllers.

In addition to configuration and schema directory partition replicas, every domain controller in a forest stores a full writeable replica of a single domain directory partition. A domain controller can locate only the objects in its domain. Locating an object in a different domain would require the user or application to provide the domain of the requested object.

To use an LDAP directory provided via Active Directory service you can use the following ports:

Default ports: 389 (LDAP) / 636 (LDAPS)

These ports are used for requesting information from the local domain controller. LDAP requests sent to port 389/636 can be used to search for objects only within the global catalogues home domain. However, the requesting application can obtain all of the attributes for those objects.

Default ports: 3268 (LDAP) / 3269 (LDAPS)

These ports are used for queries specifically targeted for the Global Catalog. LDAP requests sent to port 3268/3269 can be used to search for objects in the entire forest. However, only the attributes marked for replication to the Global Catalogue can be returned.



Online directories in XML format

A public and/or a corporate online directory in XML format can be made available to the user. Use this page to enter the provider's details and a name for the directory.

It is only available for the user role **admin**.

- ▶ Settings ▶ Online directories ▶ XML

Name The name that you have defined for the directory is displayed, or the default name (Public/Corporate). It can be edited.

Server url	If the directory is configured, the server URL is displayed.
Activation status	Indicates if a directory and what kind of directory is activated.
	The directory is activated.
	The directory is not activated.

- ▶ Select **Public** or **Corporate**

Entering the data for an XML directory

Directory name

- ▶ Enter a name for the directory. This is the name that will be displayed on the handsets when the user opens the directory list by pressing the directory key.

Server address

- ▶ Enter the URL of the online directory provider in the **Server address** field.

Username / Password

- ▶ Enter the access data for the online directory in the **Username** and **Password** fields.

List update / refresh

Activated: The result list at the handset will automatically request the next portion of results when browsing through it.

Not activated: The number of entries defined in **Maximum number of entries** is downloaded during one reading operation.

Enabling online directories

You can enable/disable different kinds of public directories (White Pages, Yellow Pages or Public Private Pages) that are provided by the given provider.

- ▶ Mark/unmark the check box next to the public directory you want to enable/disable.
- ▶ Click on **Set** to save the settings of this page.

Online directories – XSI

If one or more online directories are provided via an BroadSoft XSI service, use this page to set up the server access, enable the directories and assign directory names that are to be displayed on the users' handsets.

It is only available for the user role **admin**.



The XSI directory service must be enabled on the **Telephony – XSI Services** page (→ p. 41).

- ▶ **Settings ▶ Online directories ▶ XSI**

Online directories

Server address

If XSI services are enabled the address of the XSI server is shown here.

Enable XSI directories

- ▶ Mark the check box, if you want any of the following XSI directories to be provided on the users' handsets.

Enable specific XSI directories

- ▶ Mark the check box next to the XSI directories that should be provided.

Directory name

- ▶ For the selected XSI directories enter a name in the **Directory name** field. This is the name under which the directory will be displayed on the handsets.

Central phone book

You can provide a central phone book for all users' handsets. The phone book can be provided via a server in the network or uploaded directly from a computer to the phone system.

It is only available for the user role **admin**.

The phone book must be available in well-defined XML format. For detailed information please refer to wiki.gigasetpro.com

- ▶ **Settings ▶ Online directories ▶ Central phonebook**

Directory name

- ▶ Enter a name for the phone book in the **Directory name** field. This is the name under which the phone book will be displayed on the handsets.
- ▶ Mark the **Enable directory** option, so that the directory is displayed on the handsets.

Server address

- ▶ Enter the URL of the server providing the phone book in the text field.

Daily refresh time

The phone book will be refreshed automatically once a day.

- ▶ Enter the time when the automatic refresh should take place.

Max. number of search results

- ▶ Enter the maximum number of search results that is to be returned by one search operation.

Enable list mode

- ▶ Define what should be initially shown, when the user opens the phone book.

Activated: A list of all entries of the phone book is shown.

Not activated: An editor is opened first that allows the user to select a specific search area within the phone book and thereby to reduce the number of entries.

Load the phone book from PC

You can download an XML phone book from your computer directly to the phone system.

Phonebook file

- ▶ Click **Browse...** and select the XML phone book file from your computer's file system ▶ click on **Upload** ... the selected file is loaded and can be made available for the users.

Save the phone book to PC

You can backup the central phone book to your computer.

- ▶ Click on **Save phonebook** ▶ Select the location where the phone book should be stored using the system file selection dialogue. Enter a name for the phone book backup file.

Deleting the phone book

- ▶ Click on **Delete phonebook** to remove the phone book from the handsets.

Online services

XHTML

Additional functions as Info services, PBX control, and customer specific RAP (XHTML) applications can be made available to the user via the handset menu **Info Centre**. For this purpose four additional menu entries can be defined that will be inserted into the handset user interface.

The additional functions must be available as well formatted XHTML pages. For information on the supported XHTML format, please visit wiki.gigasetpro.com.

The page is only available for the user role **admin**.

▶ **Settings ▶ Online services ▶ XHTML**

The page shows the following information for the defined menus:

Name	The name that you have defined for the menu is displayed.
Server url	If the XHTML access is configured, the server URL is displayed.

Add SIP-ID

If the option is enabled, the device will add the SIP ID in the GET request that are addressed to the server.

▶ Mark the check box **Add SIP-ID** in order to activate the option.

Adding / editing an entry

You can define up to four menu entries.

▶ Click on  in an empty row or in a row with an already configured entry in order to edit it.

Activate

▶ Mark the option, so that the menu is displayed on the handsets.

Name for menu

▶ Enter a name in the text field (max. 22 characters). This is the name under which the menu will be displayed on the handsets.

Name for display key

▶ Enter a name in the text field (max. 8 characters). This is the name under which the display key function will be displayed on the handsets.

Server address

▶ Enter the URL of the server providing the service.

The access to the service can be protected by user name and password.

Use SIP credentials

If activated, the credentials for the user's SIP account are used (**Authentication name** and **Authentication password**, → p. 31).

Alternatively, the following credentials can be used.

Username

- ▶ Enter a user name for access to the menu (max. 22 characters).

Password

- ▶ Enter a password for access to the menu (max. 9 characters).

Online services

System settings

Web configurator access rights

On this page you define the access rights for the web configurator user interface.

It is available for both the user role **admin** and **user**. The user is only allowed to change the own password.

- ▶ Settings ▶ System ▶ Web configurator

Changing the web configurator password

For security reasons, you should frequently change the password for web configurator access.

There are two user roles with different user IDs, **admin** and **user** (→ p. 14). The **user** ID is disabled by default. You can activate it here.

The password is set depending on the user role. The administrator is allowed to change the password for both **admin** and **user**. Logged on as **user** you can only change the password for **user**.



If you have forgotten the password, you will have to reset the device to the factory settings (→ p. 11).

New password

- ▶ Enter a new password for the administrator/user access to the web configurator.
Default: **admin/user**

Repeat password

- ▶ Repeat the new password entered in the **Repeat password** field.

Show password

- ▶ To view the entered characters mark the check box near **Show password**.

Activate user access

- ▶ Click on **Yes/No** to enable/disable the ID for the **user** role.
- ▶ Enter a new password for the user access to the web configurator and repeat it.

Enabling CLI access to the device configuration

Only available for user role **admin**.

It is possible to perform the device configuration via CLI (Command Line Interface) using SSH from a remote system. Secure Shell (SSH) is a program for logging into a remote machine and for executing commands on a remote machine. It provides secure encrypted communications between two untrustworthy hosts over an insecure network.

Detailed information on CLI commands can be found in the online help of the web configurator.

System settings

Activated if password is longer than 7 characters

The CLI access is automatically enabled if you have entered a valid password that has more than seven characters and click on the **Set** button. ✓ = enabled; ✗ = disabled

CLI password

- ▶ Enter a password for the administrator access to the configuration via SSH. Value: min. 8, max. 74 characters

Repeat password



The user name for the CLI access is **cli**.

- ▶ Repeat the new password entered in the **CLI Password (Admin)** field.

Show password

- ▶ To view the entered characters mark the check box next to **Show password**.

Loading the web security certificate

Only available for user role **admin**.

The web configurator is protected by SSL/TLS security mechanism. That means that data transfer is encrypted and that the website is identified to be who it claims to be. The Internet browser checks the security certificate to determine that the site is legitimate. The certificate may be updated from time to time. If a new certificate is available you can download it to your computer or network and then upload it to the device.

- ▶ Click on **Browse...** next to **Web security certificate** and select the local certificate file from your computer's file system ▶ click on **Upload** . . . the selected certificate file is loaded and added to the certificate lists.
- ▶ If the certificate requires a password, enter it in the **Web security password** field.

Provisioning and configuration

This page allows you to define the provisioning server for the telephone system or download a configuration file and to start an auto-configuration process.

It is only available for the user role **admin**.

Provisioning is the process for uploading the necessary configuration and account data to the VoIP phones (here the DECT bases). This is done by means of profiles. A profile is a configuration file that contains VoIP phone-specific settings, VoIP provider data as well as user-specific content. It has to be available on an HTTP provisioning server which is accessible in the public (Internet) or local network.

Auto-configuration is defined as the mode of operation by which the telephone system connects automatically to a server and downloads both provider-specific parameters (such as the URL of the SIP server) and user-specific parameters (such as the user name and password) and stores them in its non-volatile memory. Auto-configuration is not necessarily limited to the parameters required for doing VoIP telephony. Auto-configuration can also be used to configure

other parameters, e.g. settings for online service, if the VoIP phones support these features. However, for technical reasons auto-provisioning is not possible for all configuration parameters of the phone.



Detailed information on how to establish a provisioning server and create provisioning profiles for Gigaset phones: → wiki.gigasetpro.com

▶ **Settings ▶ System ▶ Provisioning and configuration**

Provisioning server

- ▶ Enter the URL of your provisioning server in the text field. Value: max. 255 characters

Auto configuration file

If you have received a configuration file from your provider, you download it to the phone system.

- ▶ Click **Browse...** and select the configuration file from your computer's file system ▶ click on **Upload** ... the selected configuration file is loaded.

Start auto configuration

- ▶ Click on the button ... the provisioning profile is downloaded and installed on the system.



The process will take some time and requires a system restart. Connections with mobile devices will be terminated.

For security reasons you should save the configuration before you start an auto-configuration process (→ p. 59).

Security

The page allows you to organise the certificates used for secure internet communication and to define the credentials for HTTP authentication.

It is only available for the user role **admin**.

- ▶ **Settings ▶ System ▶ Security**

Certificates

The phone system supports the establishment of secure data connections on the Internet with the TLS security protocol (Transport Layer Security). With TLS, the client (the phone) uses certificates to identify the server. These certificates must be stored on the base stations.

Accept all certificates

- ▶ Mark the **Yes** radio button, if you want to accept all certificates.

Server certificates / CA certificates

The lists contain the server certificates or CA certificates that have been certified by a certification authority (CA). The certificates in both lists have already been implemented by default or have been downloaded via the Web configurator and are classed as valid, i.e., have been accepted.

If one of the certificates becomes invalid, e.g., because it has expired, it is transferred to the **Invalid certificates** list.

Invalid certificates

The list contains the certificates that have been received from servers but have not passed the certificate check, and certificates from the **Server certificates / CA certificates** lists that have become invalid.

Accepting / rejecting invalid certificates

Accepting a certificate:

- ▶ Select the certificate and click on the **Accept** button ... depending on its type, the certificate is transferred to one of the **Server certificates / CA certificates** lists (even if it has already expired). If a server responds again with this certificate, this connection is accepted immediately.

Reject a certificate:

- ▶ Select the certificate and click on the **Reject** button ... the certificate is transferred to the **Server certificates** list with the label **Rejected**. If a server responds again with this certificate, this connection is rejected immediately.

Checking information about a certificate

- ▶ Select the certificate and click on the **Details** button. ... a new web page appears, displaying the properties of the certificate.

Deleting a certificate from one of the lists

- ▶ Select the certificate and click on the **Remove** button. The certificate is deleted from the list immediately.

Import local certificate

You can make available further certificates to your phone system. The certificates must have been downloaded to your computer before.

- ▶ Click **Browse...** and select the local certificate file from your computer's file system ▶ click on **Upload** ... the selected certificate file is loaded and, depending on its type, added to one of the certificate lists.

HTTP authentication

Define the credentials (user name and password) for HTTP authentication. The credentials are used for HTTP digest authentication of the provisioning client with the provisioning server.

HTTP digest username

- ▶ Enter the user name for HTTP authentication. Value: max. 74 characters

HTTP digest password

- ▶ Enter the password for HTTP authentication. Value: max. 74 characters

Date and time

By default, the system is configured so that the date and time are transferred from a time server on the internet. The page allows you to change the time servers, to set your time zone, and to make arrangements in case the internet time servers are not available.

It is only available for the user role **admin**.

- ▶ **Settings ▶ System ▶ Date and time**

Time server

There are some common time servers preset in the field.

- ▶ Enter your preferred time server in the text field. Multiple time servers can be entered separated by commas. Value: max. 255 characters

Time Zone

- ▶ Select the time zone for your location from the option menu.

System time

Shows the time currently set for the phone system. It is updated every minute.

Fallback option

In case the internet time servers are not available you can set the time manually.

- ▶ Enter the time in the **System time** text field. Once you have started editing the automatic time update stops.

Act as Local Time Server

You can determine the internal time server to act as local time server for your network. If you have a time server available, you should not activate this function.

- ▶ Click on **Yes/No** to determine the internal time server to act/not to act as local time server.

System settings



Date and time are synchronised system-wide on the base station and all handsets.

Synchronisation is carried out in the following cases:

- If a handset is registered to the telephone system.
- If a handset is switched off and switched back on again, or is outside the wireless range of the telephone system for more than 45 seconds and then comes back into range.
- Automatically every night at 4.00 am.

You can change the date and time on the handset. This setting only applies for that handset and will be overwritten when the next synchronisation takes place.

The date and time are displayed in the format set for that handset.

Firmware

Use this page to make adjustments in order to keep the phone system up-to-date via firmware updates.

It is only available for the user role **admin**.

Regular updates to the firmware are provided by the operator or supplier on a configuration server. You can upload these updates onto the device as required. If a firmware update is provided in the form of an update file, you can store it on your computer and download it from there.

▶ **Settings** ▶ **System** ▶ **Firmware**

Current version

Shows the current firmware version.

Backup available for previous version

You can downgrade the firmware by installing any older version. When installing a new firmware the system automatically creates a data backup for the recent firmware. If you later downgrade to this version the data backup will be installed on the system. This way you have a downgrade to previous firmware version and data settings.



Downgrade to any other version will reset the device to factory settings.

Selecting the firmware update file

▶ In the **URL to firmware file** text field specify the URL of the configuration server where the firmware is located

or

▶ Click **Browse...** and select the firmware file from your computer's file system.

Starting the firmware update

At a specific date: ▶ Deselect the check box **Immediately** ▶ Enter the exact start time in the format: YYYY-MM-DD HH:mm

Immediately: ▶ Select the check box next to **Immediately** (default) ... the firmware update is started when you click on the **Set** button.

Confirmed schedule

Shows **Immediately** or the date for the next planned firmware update.

▶ Click on **Set** to save the settings and to start the firmware update.

Once the update process starts, the handsets lose their connection to the base. You can tell that the update has been successful when the handsets re-establish the connection to the base.



The firmware update may take up a longer period. Do not disconnect the devices from the local network during this time.

Save and restore

This page allows you to save and restore the system configuration.

It is available for both the user role **admin** and **user**. The user is only allowed to save the settings but not to restore them.

▶ **Settings** ▶ **System** ▶ **Save and restore**

Once you have configured the phone system and after making any changes to the configuration, particularly registering or de-registering handsets, you should save the latest settings in a file on the computer so that the current system can be restored quickly if problems occur.

If you change the settings accidentally or you need to reset the device due to a fault, you can reload the saved settings from the file on your computer to your telephone system.

The configuration file contains all system data including the DECT registration data of the handsets, but not the calls list on the handsets.

Saving configuration data

▶ Click on **Save settings** ▶ Select the location where the configuration file should be stored using the system file selection dialogue. Enter a name for the configuration file.

The default file name is

<MAC address of integrator><firmware version><date of export>_device-settings

Restoring configuration data

▶ Click on **Browse...** ▶ Select the previously saved configuration file from the file system of your computer. ▶ Click on **Upload** ... the selected configuration file is loaded.



The secured configuration file can also be loaded onto a new device.

Prerequisites:

- The old device must no longer be in operation.
- The firmware version of the new device must correspond, at least, with the version of the device from which the data is saved, including the set patches.

Reboot and reset

This page allows you to reboot the device and to reset the system to factory settings. It is available for both the user role **admin** and **user**.

- ▶ **Settings** ▶ **System** ▶ **Reboot and reset**

Manual reboot

- ▶ Click on **Reboot now** ▶ Confirm with **Yes** ... the reboot starts immediately.

Reset to factory settings

All configuration settings can be reset to the factory default. This will delete all settings, disconnect all connections, and terminate all calls!



When resetting to factory defaults all settings are lost. You can save your current configuration previously (→ p. 59).

Factory reset can also be performed by using the device key.

Defining the role

- ▶ From the **Reset to device** options menu, select the network configuration with which the device is to be restarted after the reset. **All in one** is the default configuration for Gigaset N610 IP PRO and means that all three components are active (Integrator + DECT Manager + Base Station).

All in one - dynamic IP

The network configuration is set to dynamic IP.

All in one - static IP

The network configuration is set to the following static IP settings:

IP address:	192.168.143.1
Subnet mask:	255.255.0.0
Gateway:	192.168.1.1

Resetting the device

- ▶ Click on the **Reset to** button to reset the device to factory condition according to the selection made in **Reset to device** ... a confirmation dialogue is opened ▶ confirm with
 - Yes** The **Save and restore** page is opened allowing you to save the current configuration on your computer (→ p. 59).
 - No** The reset procedure starts at once. The current configuration will be lost.
 - Cancel** The reset procedure is interrupted.

DECT settings

This page allows you to make settings for the DECT radio network.
It is only available for the user role **admin**.

► Settings ► System ► DECT settings



Changing one of these settings requires a restart of the system. Ongoing calls will be cancelled.

ECO DECT

ECO DECT is an environment-friendly technology which reduces the power consumption and enables a variable reduction of transmission power.

DECT Radiation power

► Set the DECT radiation power to your needs:

Maximum range: The device range is set to maximum (default). This guarantees the best connection between the handset and the base stations. In idle status, the handset will not send radio signals. Only the base station will maintain contact with the handset via a low wireless signal. During a call, the transmission power automatically adapts to the distance between the base station and handset. The smaller the distance to the base, the lower the radiation.

Limited range: The radiation is reduced by up to 80 %. This will also reduce the range.

DECT security settings

DECT radio traffic between base stations and handsets is encrypted by default. The following options allow you to define the security settings in more detail.

DECT Encryption

► Activate/deactivate the option.

Activated: All calls are encrypted.

Deactivated: No calls are encrypted.

Enhanced Security - Early Encryption and Re-Keying

► Activate/deactivate the option.

Activated: The following messages are encrypted:

- CC (Call Control) messages in a call
- Data that may be sensitive at early stages of the signalling, e.g., dialling or CLIP information sending

The key used for encryption is changed during an ongoing call and thus improving the security of the call.

Deactivated: No CC messages or early data are encrypted.

System settings

Enhanced Security - Automatic release for non-encrypted calls

- ▶ Activate/deactivate the option.

Activated: If encryption is activated, it will be released in the case that a call is initiated by a device that is not supporting encryption.

Deactivated: Encryption is never released.

DECT radio settings

Due to different national regulations DECT units are required to use different frequency ranges to make them compatible with DECT systems in other areas. You can adapt the frequency range of the N610 IP PRO to the requirements of your region.

DECT Radio band

- ▶ Select the radio frequency band used in your region.



Please select the DECT frequency band your system should operate according to your region. This is a system wide setting. Changing the setting will reboot the DECT radio part. Wrong setting may cause violation of legal regulations. In case of doubt, contact your Telecommunications Authority.

Diagnostics and troubleshooting

Status information

The status page offers important information on the system operation and the involved devices.

► Status ► Overview

The following information is provided.

- Integrator status**
- Device name
 - Device role
 - MAC address
 - IP address
 - DECT Frequency band
 - DECT PARI
 - Firmware version
 - Date and time
 - Last backup

Note: The integrator is the central management station of a DECT network. In single-cell systems, it is integrated as a software component in the base station.

- Mobile devices**
- Number of registered mobile devices (reachable/all)
 - Number of mobile devices to register
 - Number of mobile devices with SIP registration (connected/all)

- Click on  See also... in the header line ... a list of all pages providing information or settings for diagnostic purposes is shown.

System backup

Besides **Last backup** date and time of the last backup is shown. As long as no backup has been created, **Never** is displayed instead.

Creating a new backup or restoring an existing backup file:

- Click on  **System** ► **Save and restore** ... the **Save and restore** page is opened.
(→ p. 59)

Administration of DECT manager, base stations or mobile devices

For DECT managers, base stations, and mobile devices you can directly jump to the associated Web configurator page.

- Click on the  button next to the corresponding entry in the table.

Base station events

This page displays counters for diagnostic purposes relating to various events that affect the base station, e.g. active radio connections, unexpectedly terminated connections, etc.

It is available for both the user role **admin** and **user**.

► Status ► Statistics ► Base stations

The following information is given:

DECT Manager ► Click on  next to the **DECT Manager** entry to display the clusters of the DECT manager.

Cluster Cluster number, summary of the collected events
A cluster includes all base stations of a DECT network. A singlecell system or a mini multicell system always has only one cluster. Therefore the cluster number is always 1.

► Click on  next to the **Cluster** entry to display the base station information.

Base station Name of the base station



Some of the following information may be hidden. Use the **View** option menu to display the desired columns.

Properties

MAC address MAC address of the base station

RPN Radio Fixed Part Number, identifying the radio-entity

Sync RPN RPN of the other base station the base station is synchronising with

Sync Level Synchronisation level

Statistics

Conn Number of connections, i.e. calls made

Ho setup Number of incoming handovers

Ho release Number of outgoing handovers

Call drops Number of lost connections, i.e. interrupted calls

Async How often the base station has lost on-air DECT synchronisation

Busy How often the maximum number of possible connections of the module was achieved.

Conn. drops How often the LAN connection to the base station was interrupted

Calls Active calls

Calls-pk Peak number of parallel calls

Sync swaps Number of sync swaps, i.e. , how often the sync master has been changed due to a sync master crash.

q-idx-It	LAN synchronisation quality > 90% LAN sync is functional. The remaining 10% evaluate the synchronisation quality. > 93% Good synchronisation quality.
o-thr-exc	PTP offset threshold exceeded counter If the PTP deviation > 500 ns, the counter is increased. The requirement for the network is that the PTP deviation is < 500 ns.
d-thr-exc	DLS offset threshold exceeded counter If the DLS deviation > 1000 ns, the counter is increased.

Synchronisation-specific (Sync) and handover-specific values (Ho) are not relevant for single cell systems.

Actions

Displaying detailed statistical data on the base stations

- ▶ Click on the  button next to the name of a base station ... statistical evaluations about the base station synchronisation as well as further system information are output.

Exporting the information into a CSV file

For further processing of the statistic data you can export the data into a file with CSV (Comma separated Value) format.

- ▶ Click on **Export** ▶ Select the location where the file should be stored using the system file selection dialogue.

Resetting the statistics

- ▶ Click on **Reset all** ... the counters in the table are reset to 0.

Filtering the list

- ▶ From the **Choose column** option menu select the column for which you want to set a filter. Note that columns may be hidden.
- ▶ In the text field enter the filter criteria ▶ Click on **Filter** ... only the entries matching the filter are shown.

For filtering the list according to specific counter values the following operators are possible:

< less than > more than = equal to
<= less or equal >= more or equal

For the **MAC address** column only the following condition is allowed: = MAC address
The MAC address must be in the following format: **aabbccddeeff** (without colons)

Deleting the filter: ▶ Click on **Clear**

Diagnostics and troubleshooting

Examples:

Only base stations with more than 20 busy situations should be displayed in the table. This could be achieved by the following filter settings.

Busy >20 Filter Clear

Only base stations with less than 5 call interruptions should be displayed in the table. This could be achieved by the following filter settings.

Call drops <5 Filter Clear

Displaying/ hiding columns

- ▶ Click on the **View** option menu on the right ▶ Select the columns you want to be displayed in the table (👁 / 👁 = displayed/hidden).

Names of columns which cannot be hidden are greyed out.

Incidents

The page contains information on incidents concerning system operation.

It is available for both the user role **admin** and **user**. The user is not allowed to delete entries.

- ▶ **Status** ▶ **Statistics** ▶ **Incidents**

Timestamp	Date and time of the incident
DECT Manager	DECT manager affected
Incident Type	e.g. Crash, Reboot, Reset
Severity	Degree of severity: Critical, High, Medium, Low, Info
Info	Detailed information, e.g., the component producing the incident

Actions

Downloading detailed information to a file

To get detailed information about the circumstances causing the error, you can download the incident information to a file. If required, you can pass it to the responsible service personnel.

- ▶ Mark the check box next to one or more incidents you want to download or next to **Timestamp**, if you want to download all incidents.
- ▶ Click on **Download** and select the desired file location for the log files in the file system . . . for each selected incident a log file is created. All log files are taken into a tar file.

Deleting entries

- ▶ Mark the check box next to one or more incidents you want to delete or next to **Timestamp**, if you want to delete all incidents.
- ▶ Click on **Delete**.

Refreshing the list

- ▶ Click on **Refresh**, to update the information in the table.

System log and SNMP manager

The system report (SysLog) gathers information about selected processes performed by the phone system during operation and sends this to the configured SysLog server.

It is only available for the user role **admin**.

- ▶ **Settings ▶ System ▶ System log**

Activate system log

- ▶ Mark/unmark the check box to activate/deactivate the logging function.

Server address

- ▶ Enter the IP address or the (fully qualified) DNS name of your Syslog server. Value: max. 240 characters

Server port

- ▶ Enter the port number, where the Syslog server expects to receive requests.

Range: 1-65535; Default: 514

Log level

- ▶ Mark/unmark the check boxes next to the log information that should be included/not included in the system log.

The **Use on all DECT Managers** button is not relevant to single and mini multicell systems.

SNMP statistics

The Simple Network Management Protocol (SNMP) is a common protocol used for monitoring and controlling of network devices. To gather management and statistic information concerning base station events to be processed by an SNMP manager you have to enter the address and authentication information according to the SNMP server configuration.

- ▶ Enter the IP address of the SNMP manager server in the **SNMP manager address** field and the port number used by the SNMP manager in the **SNMP manager port** field. Default: 162

To access the SNMP database authentication is necessary.

- ▶ Enter the **SNMP username** and the **SNMP password**.

The **Use on all DECT Managers** button is not relevant to single and mini multicell systems.

- ▶ If the access data defined here should be used for all DECT managers, click on **Use on all DECT Managers**.

Storing management information in MIB format

You can store management information for all base stations in MIB syntax.

- ▶ Click on **Download MIB** ▶ Select the location where the MIB file should be stored using the system file selection dialogue. . . . the file with the MIB information is stored in TXT format.

Diagnostics

For diagnostic purposes you can create a dump with different contents. A dump may help software developers and system administrators to diagnose, identify and resolve problems that led to system failures.

► Settings ► System ► Diagnostics

A standard set of diagnostic info will be downloaded. Additionally you can add following options:

Core dump	Includes, if available, a core dump of a crashed application.
Ram dump	Includes, if available, a RAM dump of a crashed CSS (co-processor for DECT and media real-time processing). Core dump and CSS RAM dump can be used by service personnel for post-mortem debugging. Because the file size is several MBytes, not all data can be collected due to limited overall sysdump file size. Therefore, these options should be used carefully.
Last incident sysdump	Dump of the last incident. Contains only the system memory part that represents the last incident.

- Mark the check mark next to the dump type you want to include.
- Click on **Download** ► Select the location where the dump file should be stored using the system file selection dialogue. Enter a name for the dump file. The file is stored as tar archive. The default file name is
 <MAC address of integrator><firmware version><date of export>_diagnostics.tar

Using a handset connected to an N610 IP PRO base

The functions of your N610 IP PRO are available on the registered handsets. The functions of the telephone system are added to the handset menu. Handset-specific functions, e.g., local directory or organiser, are not described here. Information about this will be found in the relevant handset user guide. The availability of functions or their designations may differ on individual handsets.



For information about which Gigaset handsets support the complete functionality of the N610 IP PRO multicell system please refer to wiki.gigasetpro.com.

Making calls

You can make calls using any handset registered to your N610 IP PRO.

Each handset is assigned a send and receive connection (→ p. 31).

If your N610 IP PRO is connected to a PBX that permits the formation of groups, VoIP connections can also be assigned to groups. In this case, you will also receive calls on your handset that have been sent to your group number.

The N610 IP PRO uses a VoIP PBX or the services of a VoIP provider for Internet telephony. The availability of some phone functions depends on whether they are supported by the PBX/provider and whether they have been enabled. If necessary, you can obtain a description of the services from the operator of your PBX.



Depending on the specifications of your PBX, you may need to dial an access code for calls outside the area covered by your VoIP PBX (→ p. 39).

Calling

▶ ... use to enter a number ▶ Briefly press the Talk key

or

▶ Press and **hold** the Talk key ▶ ... use to enter a number

The connection is established using the SIP connection assigned to the handset (→ p. 31).



If you make a call to the fixed line network, you may also have to dial the area code for local calls (depending on the PABX/provider). This is not necessary if the area code is entered in the telephony configuration (→ p. 40).

Dialling from the redial list







The redial list contains the numbers last dialled with the handset.

▶ Briefly press the Talk key ... the redial list is opened ▶ ... use to select an entry ▶ Press the Talk key

Using a handset connected to an N610 IP PRO base

Dialling from the call list

The call lists contain the most recent accepted, outgoing and missed calls.

- ▶  ▶ ... use  to select  **Call Lists** ▶ **OK** ▶ ... use  to select a list ▶ **OK** ▶ ... use  to select an entry ▶ Press the Talk key 



The **Missed calls** list can also be opened by pressing the Message key .

Initiating ringback

If the number you have called is engaged or the participant called does not reply, you can arrange a ringback if your PBX/provider supports the CCBS and CCNR services.

CCBS (Completion of Call to busy Subscriber) Ringback if busy

CCNR (Completion of Calls on No Reply) Ringback if no answer

The service code for activating/deactivating CCBS, CCNR must be configured with the provider settings (→ p. 27).

Activating ringback:

- ▶ Enter the service code defined for the PBX/provider, e.g., *6

If you decide you do not want a ringback, you can switch the function off again:

- ▶ Enter the service code defined for the PBX/provider, e.g., #6

Accepting calls

Incoming calls for the connection assigned to your handset are signalled.

- ▶ Press the Talk key  to accept the call.

Switch off ringtone: ▶ **Silence** ... the call can be accepted for as long as it is shown on the display

Reject a call: ▶ Press the End call key 

Information about the caller

The caller's phone number is displayed, if provided. If the caller's number is saved in the directory, the name is displayed.

Using a PBX call manager

In case a PBX call manager is used it is possible to define that incoming calls are accepted directly via headset or handsfree. This has to be configured for the handset via web configurator in the **Call manager** section (→ p. 34).



Group pickup

You can also accept incoming calls for the group.

Group pickup must be activated and the call number or SIP URI of the group must be entered. This has to be configured for the handset via web configurator in the **Group pick-up** section (→ p. 33)

Accepting/rejecting call waiting

A call waiting tone indicates a call during an external call. The number or the name of the caller is displayed if the phone number is transferred.

- Reject a call: ▶ **Options** ▶  **Reject waiting call** ▶ **OK**
- Accept a call: ▶ **Accept** ▶ ... speak to the new caller. The previous call is placed on hold.
- End the call, resume the on-hold call: ▶ Press the End call key .

Conversation with three participants



Consultation calls

Make another external call during an external call. The first call is placed on hold.

- ▶ **Ext. Call** ▶ ... use  to enter the number of the second participant ... the active call is placed on hold and the second participant is called

If the second participant does not answer: ▶ **End**

Ending a consultation call



- ▶ **Options** ▶  **End active call** ▶ **OK** ... the connection to the first caller is reactivated
- or
- ▶ Press the End call key  ... a recall to the first participant is initiated

Call swapping

Switching between two calls. The other call is placed on hold.

- ▶ During an external call, dial the number of a second participant (consultation call) or accept a waiting caller ... the display shows the numbers and/or names of both call participants
- ▶ Use the control key  to switch back and forth between participants

Ending a currently active call

- ▶ **Options** ▶  **End active call** ▶ **OK** ... the connection to the other caller is reactivated
- or
- ▶ Press the End call key  ... a recall to the first participant is initiated

Using a handset connected to an N610 IP PRO base

Conference

Speaking to both participants at the same time.

- ▶ During an external call, dial the number of a second participant (consultation call) or accept a waiting caller ... then

Initiate conference call:

- ▶ **Conf.** ... all callers can hear one another and hold a conversation with one another

Return to call swapping:

- ▶ **End Conf.** ... You will be reconnected to the participant with whom the conference call was initiated



End call with both participants:

- ▶ Press the End call key 

Each of the participants can end their participation in the conference call by pressing the End call key  or hanging up.

Call transfer

Connecting an external call with a second external participant.

- ▶ Use the display key **Ext. Call** to establish an external consultation call ▶ ... use  to enter the number of the second participant ... the active call is placed on hold ... the second participant is called ▶ press the End call key  (during a conversation or before the second participant has answered) ... the call is transferred



Call transfer options must be set correctly for the PBX/provider (→ p. 39).

Message indication

Notifications about accepted and missed calls, missed alarms and messages on the network mailbox are saved in messages list and can be displayed on the handset display.

Which messages are displayed on the handset is defined during handset configuration in the **Missed calls and alarms** section (→ p. 34)

Missed calls count

If the option is activated, the number of missed and accepted calls will be shown on the handset display in idle mode.

Message Waiting Indication (MWI)

For each message type (missed call, missed alarm, new message the network mailbox) the MWI option can be activated or deactivated via the web configurator.

If activated, the LED on the message key  flashes, in the case a **new message** arrives indicating missed calls, missed alarms or new messages on the network mailbox.

Using directories

The options are:

- The (local) directory for your handset (see handset user guide)
- Corporate directories provided by an LDAP server (→ p. 75)
- Miscellaneous online directories

The directories available are defined by the web configurator of the telephone system (→ p. 42).

Opening directories

Opening the corporate directory using the INT key

The INT key  (press left on control key) on the handsets opens a corporate directory, provided that this is set up via the web configurator using the **Corporate directory for INT key** option and can be accessed by the telephone system. The directory to be opened can be set for each handset (→ p. 32).

Opening directories using the directory key

The directory key  (press down on the control key) for the handset is normally set as follows:

- Press **briefly** to open the selection of available network directories.
- Press and **hold** to open the local directory



This assignment can be changed for each handset via the web configurator using the **Directory for direct access** option (→ p. 32). Direct access can be assigned to a specific online directory. In this case, open the local directory by pressing and holding the directory key.

The description below assumes the default assignment.

Opening directories via the menu

Depending on the handset used you can access all available directories also via the handset's menu:

Local directory

▶  ▶ ... use  to select  **Directory** ▶ **OK**

List of all online directories set up on the telephone system

▶  ▶ ... use  to select  **Net Directories** ▶ **OK**

The directories are displayed with the names specified in the web configurator.

Example for handling a corporate directory on the handset → p. 81



If handsets are connected to an N610 IP PRO, it is not possible to transfer entries from the local directory to another handset.

Using a handset connected to an N610 IP PRO base

Using the network mailbox

The network mailbox accepts incoming calls made via the corresponding line (corresponding VoIP phone number).

Prerequisites

In order to allow the user to listen voice messages stored on a network mailbox the following settings are necessary:

On the VoIP PBX

- ▶ Set up a network mailbox for the VoIP connection that is to be assigned to the handset.

On the N610 IP PRO

- ▶ In the provider/PBX configuration activate the **SIP SUBSCRIBE for Net-AM MWI** option (→ p. 23). A subscription is established for the purpose of receiving notifications about new messages on the network mailbox.
- ▶ In the mobile devices configuration enter the **Call number or SIP name (URI)** and activate the network mailbox in the **Network mailbox configuration** section (→ p. 33).
- ▶ Optional: In the mobile devices configuration enable the **Flashing LED (MWI) for network mailbox** option (→ p. 34). New messages on the network mailbox are indicated by the MWI light on the Message key.





Playing back messages on the handset

- ▶ Press and hold  (if key 1 has been assigned to the network mailbox)

or

- ▶ Press the Message key  ▶ ... use  to select the network mailbox ▶ OK

or

- ▶  ▶ ... use  to select  **Answer Machine** ▶ OK ▶ **Play Messages** ▶ OK ▶  **Network Mailbox** ▶ OK

Listen to announcement out loud: ▶ Press the handsfree key 

LDAP directory – configuration example

To allow the entries of an LDAP directory to be displayed on the handsets, you will need to configure the phone's LDAP client. This involves the following:

- Setting up access to the LDAP server and database
- Specifying the attributes to be displayed (→ p. 80)
- Defining search criteria (filters) (→ p. 77)







Access to the LDAP server

To ensure that entries from the LDAP database are displayed on the phones, enter the access data via the web configurator.

► Settings ► Online directories ► Corporate

- Click on  next to the name of the LDAP directory you want to edit ... the LDAP configuration page is opened.

Access to the LDAP data server

Directory name 	<input style="width: 90%;" type="text" value="Our Directory"/>
	<input type="checkbox"/> Enable directory
Server address 	<input style="width: 90%;" type="text" value="ldap.ourserver.com"/>
Server port 	<input style="width: 90%;" type="text" value="389"/>
LDAP Search base (BaseDN) 	<input style="width: 90%;" type="text" value="cn=phonebook,dc=example,dc=com"/>
Username 	<input style="width: 90%;" type="text" value="cn=user_1,ou=users,dc=company,dc=com"/>
Password 	<input style="width: 90%;" type="password" value="••••••••"/>
Secure LDAP	<input style="width: 90%;" type="text" value="None"/>

- Enter a name for the directory in the **Directory name** field.
This is the name under which the directory will appear in the list of network directories on the telephones (→ p. 81).
- Select the option **Enable directory**, so that the directory will be displayed on the telephones.
- Enter the access data for the LDAP server

Server address	IP address or domain name of the LDAP server, e.g. 10.25.62.35 or ldap.example.com
Server port	Port on which the LDAP server expects queries from the clients. Normally the port number 389 is used (default).
Username / Password	Credentials for access to the LDAP server.

LDAP directory – configuration example



It is also possible to use individual access data for each handset (→ p. 31).

LDAP Search base (BaseDN)

The **LDAP Search base (BaseDN)** parameter specifies the starting point for the search in the LDAP directory tree. This starting point must be defined on the LDAP server and entered here for the LDAP client according to the server configuration. BaseDN is a special LDAP name which represents an object including its position in a hierarchical directory.

BaseDN is used to define which section of the hierarchical LDAP database is to be searched. Access to the entire directory can be enabled (e.g. to the corporate directory) or only to a subdirectory (e.g. the directory of a particular organisational unit).

BaseDN is created from series of RDNs (Relative Distinguished Names) found by walking up the directory information tree.

The BaseDN is specified as follows:

- The directory hierarchy is specified from left to right from the lowest level to the highest, e.g. object, organisational unit, organisation, domain.
- A hierarchical level has the following format: keyword=object, e.g. cn=PhoneBook.
- Hierarchical levels are separated by commas.
- It must be unique in the directory information tree.

The following objects are often used as hierarchical levels:

cn: common name
ou: organisational unit
o: organisation
c: country
dc: domain component

But other objects can also be used. For this parameter you require information on the structure of the LDAP server.

For the meaning of the objects, see section **Filters** → p. 77

Examples:

Starting point: Object PhoneBook, in the domain example.com

Definition: cn=PhoneBook,dc=example,dc=com

Starting point: Object PhoneBook in the subdirectory sales/support, in the domain example.sales.com.

Definition: cn=PhoneBook,o=support,ou=sales,dc=example,dc=sales,dc=com

Filters

With filters you define criteria by which the phone searches for certain objects in the LDAP database

- The name filter determines which attributes are used in the search for directory entries.
- The number filter specifies which attributes are used for the automatic search in the LDAP database when phone numbers are entered.
- Additional filters can be defined to enable detailed search.

Search in LDAP database

Enable list mode ?

Name filter ?

Number filter ?

Additional filter #1 name ?

Additional filter #1 value ?

Additional filter #2 name ?

Additional filter #2 value ?

Display format ?

Max. number of search results



The LDAP protocol offers various setting options for filters and search functions, e.g. wildcards, fixed character strings and further operators. For full details see the [RFC 4515](#).

Filter format

A filter consists of one or more criteria. A criterion defines the LDAP attribute in which the entered string is to be searched for, e.g. sn=%. The percent sign (%) is a placeholder for the user input.

Operators

Following operators can be used to create filters:

Operator	Meaning	Example
=	Equality	(attribute1=abc)
!=	Negation	!(attribute1=abc)
>=	Greater than	(attribute1>=1000)

LDAP directory – configuration example

Operator	Meaning	Example
<=	Less than	(attribute1 <=1000)
~	Proximity (LDAP server dependent)	(attribute1 ~ =abc)
*	Wildcard	(attr1=ab*) or (attr1=*c) or (attr1=*b*)

Multiple criteria can be connected with logical AND (&) and/or OR operators (|). The logical operators "&" and "|" are placed in front of the criteria. The criterion must be placed in brackets and the whole expression must be bracketed again. AND and OR operations can also be combined.

Examples

AND operation: (&(givenName=%)(mail=%))

Searches for entries in which the first name **and** e-mail address begin with the characters entered by the user.

OR operation: (|(displayName=%)(sn=%))

Searches for entries in which the display name **or** surname begins with the characters entered by the user.

Combined operation: (|(&(displayName=%)(mail=%))(&(sn=%)(mail=%)))

Searches for entries in which the display name **and** e-mail address **or** the surname **and** e-mail address begin with the characters entered by the user.

Special characters

It is also possible to find entries containing special characters. If you want to compare these characters within an attribute string use backslash (\) and a 2-digit hex ASCII code as follows:

Special character	ASCII code
(\28
)	\29
<	\3c
>	\3e
/	\2f
\	\2a

Special character	ASCII code
=	\3d
&	\26
~	\7e
*	\2a
	\7c

Example

(givenName=James \28Jim\29)

will find any entry with givenName attribute's value equal to "James (Jim)"

Name filter

The name filter determines which attributes are used for the search in the LDAP database.

Examples:

- (displayName=%) The attribute **displayName** is used for the search.
 The percent sign (%) is replaced with the name or part of the name entered by the user.
 If you enter e.g. the character "A", the phone searches the LDAP database for all entries in which the attribute **displayName** begins with "A". If you then enter a "b", it searches for entries in which the **displayName** begins with "Ab".
- ((cn=%)(sn=%)) The attributes **cn** or **sn** are used for the search.
 If you enter e.g. the character "n", the phone searches the LDAP database for all entries in which the attribute **cn** or **sn** begins with "n". If you then enter an "o", it searches for entries in which the attribute **cn** or **sn** begins with "no".



LDAP does not distinguish between upper and lower case in the search request.

Number filter

The number filter defines which attributes are used in the automatic search for a directory entry. The automatic search is performed when a phone number is entered and in the case of an incoming call with calling line identification. If an entry is found for a phone number, the display shows the name instead of the number.

Entries are only found and displayed if the stored phone number matches the entered phone number exactly.

Examples:

- (homePhone=%) The attribute **homePhone** is used for the search.
 The percent sign (%) is replaced with the phone number entered by the user.
 If you enter the numbers "1234567" when dialling, the phone searches the LDAP database for entries with the private phone number "1234567".
- ((telephoneNumber=%)(mobile=%)(homePhone=%))
 The attributes **telephoneNumber**, **mobile** and **homePhone** are used for the search.
 If you enter the numbers "1234567" when dialling, the phone searches the LDAP database for entries with the private **or** mobile **or** work number "1234567".

Attributes

For a directory entry (an object), a series of attributes are defined in the LDAP database, e.g. surname, first name, phone number, address, company etc. The set of all attributes that can be stored for an entry is stored in the schema of the relevant LDAP server. To access attributes or define search filters, you must know the attributes and their names in the LDAP server. Most attribute names are standardised, but there can also be specific ones defined.

Which attributes can actually be displayed on a phone depends on

- which attributes are defined for an entry in the LDAP database,
- which attributes are set in the web configurator for display on the phone,
- which attributes can be displayed on the phone or handset.

Available attributes on handsets or phones

The following table shows the attributes that could be used for a directory entry on a handset or phone. Of course, the set of attributes that are actually shown depends on the specific handset used.

Attributes of a directory entry	Attribute name in the LDAP database
First name	givenName
Surname	sn, cn, displayName
Phone (home)	homePhone, telephoneNumber
Phone (office)	telephoneNumber
Phone (mobile)	mobile
E-mail	mail
Fax	facsimileTelephoneNumber
Company	company, o, ou
Street	street
City	l, postalAddress
Zip	postalCode
Country	friendlyCountryName, c
Additional attribute	can be freely defined

Specifying attributes for display on the phone

In the web configurator you specify which of the available attributes from the LDAP database are to be queried and displayed on the phone.

- ▶ For each attribute of a directory entry, select the appropriate attribute from the LDAP database. There are predefined settings at choice. Alternatively you can enter manually a different attribute defined in the LDAP database for this field.
- ▶ If an attribute is not to be displayed, select the option **none**.

In the **Additional attribute** field, you can enter an additional attribute that is available in the LDAP database and should be displayed. If the attribute is a number to be dialled, the option **Additional attribute can be dialled** must be checked.

The attributes **First name** and **Surname** will be used for the following functions:

- Display in the list of directory entries in the form **Surname, First name**
- Alphabetical sorting of the directory entries on the phone
- Name display of a caller or call participant

If the database query only produces one of the attribute values (e.g. because a contact is only stored with their first name), only this one will be displayed.

Display on the handsets

If one or more LDAP directories are set up in the web configurator, they will be available on the handsets with the following functions:

- Scroll through directory or search for directory entries,
- Display directory entries with detailed information (no edit or delete),
- Dial phone numbers directly from the directory,
- Add directory entries to the local directory.

When a phone number is entered or a call comes in, the directory is automatically searched for an entry that matches the phone number. If an entry is found, the name is displayed instead of the phone number.

To display the corporate directory on the telephone screen

The corporate directory is assigned to the INT key: ▶ press 



Depending on the settings for the handset in the web configurator (→ p. 32), you may also be able to access a corporate directory via the directory key .

Some handsets provide access also via the display menu. For details, see the user guide for your phone.

Entries in the directory

The following description shows an example for the display of an LDAP directory on a handset.

The menu shows all directories that have been set up and activated on the **Online directories** page in the web configurator. Each one appears with the name entered under **Directory name** in the web configurator (→ p. 75). In the example on the right, the LDAP directory is shown as **Our Directory**.

▶ ... use  to select the directory ▶ **OK**

The phone initiates a query to the LDAP server defined in the web configurator.

Directories	
Our Directory	
Directory 3	
Directory 4	
Directory 5	
Directory 6	
Back	OK

LDAP directory – configuration example

The LDAP directory is displayed according to the following rules:

- The search begins in the directory/subdirectory which is defined as the search base on the LDAP server and specified with the **LDAP Search base (BaseDN)** parameter in the web configurator (→ p. 76).
- The entries are listed in alphabetical order.
- The entries are displayed with **Surname** and **First name** if both attributes are available in the LDAP database. Otherwise only the surname or first name is displayed.

Our Directory	
Albert	
Bond	
Bond, James	
Bond, Paul	
Brown, Charly	
View	Options

Searching the directory

- ▶ Use  to scroll through the directory

or

- ▶ Use  to enter a name (or the first few letters).

As soon as you press a key on the keypad, the telephone goes into search mode. You can enter up to 15 characters. All entries in the LDAP directory that match your input are displayed.



b	
Bond	
Bond, James	
Bond, Paul	
Brown, Charly	
< C	Options

br	
Brown, Charly	
< C	Options

- ▶ Use  to delete the last character you entered.

The current search string is shown in the top line.



Displaying a directory entry

- ▶ Use  to select the entry you want.
- ▶ Press the display key **View** or the navigation key .

or



- ▶ Press the display key **Options** ▶ **View**

The directory entry is displayed with its detailed information. Only attributes for which a value is stored are shown (→ p. 77).



- ▶ Use  to scroll through the entry.
- ▶ Press the End call key  or the **Back** display key to close the entry.

Brown, Charly
Surname: Brown
First Name: Charly
Phone (home): 1234567890
Back

Dialling a number from the directory

- ▶ Use  to select the entry you want in the directory.
- ▶ Press the Talk key . If only one phone number is stored, it is dialled. If there are several phone numbers, they are displayed in a selection list.







or

- ▶ Use  to select the phone number you want in the detailed view of an entry: **Phone (home)**, **Phone (office)** or **Phone (mobile)**.
- ▶ Press the Talk key . The number is dialled.

Brown, Charly
Phone (office): 0987654321
Phone (mobile): 0908987876
Street: Avenue 12
Back

Appendix

Safety precautions

	<p>Read the safety precautions and the user guide before use.</p> <p>Comprehensive user guides for all telephones and telephone systems as well as for accessories can be found online at gigasetpro.com in the Support category. We thereby help to save paper while providing fast access to the complete up-to-date documentation at any time.</p> <p>The device cannot be used in the event of a power failure. In case of a power failure it is also not possible to make emergency calls.</p>
	<p>Do not use the devices in environments with a potential explosion hazard (e.g. paint shops).</p>
	<p>The devices are not splashproof. For this reason do not install them in a damp environment such as bathrooms or shower rooms.</p>
	<p>Use only the power adapter indicated on the device.</p> <p>Use only the cable supplied for LAN connection and connect it to the intended ports only.</p>
	<p>Remove faulty devices from use or have them repaired by our Service team, as these could interfere with other wireless services.</p>
	<p>Using your telephone may affect nearby medical equipment. Be aware of the technical conditions in your particular environment, e.g. doctor's surgery. If you use a medical device (e.g. a pacemaker), please contact the device manufacturer. They will be able to advise you regarding the susceptibility of the device to external sources of high frequency energy (for the specifications of your Gigaset product see "Specifications" → p. 87).</p>

Service (Customer Care)

For further information and services concerning your product please refer to wiki.gigasetpro.com:

- Products
- Documents
- Interop
- Firmware
- FAQ
- Support

Our Gigaset pro reseller will be happy to help with any further questions related to your Gigaset N610 IP PRO.

Authorisation

Voice over IP telephony is possible via the LAN interface (IEEE 802.3).

Depending on your telecommunication network interface, an additional router/switch could be necessary.

For further information please contact your Internet provider.

This device is intended for use worldwide. Use outside the European Economic Area (with the exception of Switzerland) is subject to national approval.

Country-specific requirements have been taken into consideration.

Hereby, Gigaset Communications GmbH declares that the radio equipment type Gigaset N610 IP PRO is in compliance with Directive 2014/53/EU.

The full text of the EU declaration of conformity is available at the following internet address: www.gigaset.com/docs.

This declaration could also be available in the "International Declarations of Conformity" or "European Declarations of Conformity" files.

Therefore please check all of these files.

Environment

Our environmental statement

We at Gigaset Communications GmbH are aware of our social responsibility. That is why we actively take steps to create a better world. In all areas of our business – from product planning and production to sales and waste of disposal – following our environmental conscience in everything we do is of utmost importance to us.

Learn more about our earth-friendly products and processes online at www.gigaset.com.

Environmental management system



Gigaset Communications GmbH is certified pursuant to the international standards ISO 14001 and ISO 9001.

ISO 14001 (Environment): Certified since September 2007 by TÜV SÜD Management Service GmbH.

ISO 9001 (Quality): Certified since 17/02/1994 by TÜV SÜD Management Service GmbH.

Disposal

All electrical and electronic products should be disposed of separately from the municipal waste stream via designated collection facilities appointed by the government or the local authorities.



This crossed-out wheeled bin symbol on the product means the product is covered by the European Directive 2012/19/EU. The correct disposal and separate collection of your old appliance will help prevent potential negative consequences for the environment and human health. It is a precondition for reuse and recycling of used electrical and electronic equipment.

For more detailed information about disposal of your old appliance, please contact your local council refuse centre or the original supplier of the product.

Appendix

Care

Wipe the device with a **damp** cloth or an antistatic cloth. Do not use solvents or microfibre cloths.

Never use a dry cloth; this can cause static.

In rare cases, contact with chemical substances can cause changes to the device's exterior. Due to the wide variety of chemical products available on the market, it was not possible to test all substances.

Impairments in high-gloss finishes can be carefully removed using display polishes for mobile phones.

Contact with liquid

If the device comes into contact with liquid:

- 1 **Disconnect the power supply.**
- 2 Allow the liquid to drain from the device.
- 3 Pat all parts dry.
- 4 Place the device in a dry, warm place **for at least 72 hours** (not in a microwave, oven etc.) with the battery compartment open and the keypad facing down (if applicable).
- 5 **Do not switch on the device again until it is completely dry.**

When it has fully dried out, you will normally be able to use it again.

Technical data

Specifications

Power consumption

N610 IP PRO (base station)

< 3.8 W

General specifications

Power over Ethernet	PoE IEEE 802.3af < 3.8 W (Class 1)
LAN interface	RJ45 Ethernet, 10/100 Mbps Protection class IP20
Ambient conditions for operation	+5°C to +45°C indoors; 20% to 75% relative humidity
Protocols	IPv4, SNTP, DHCP, DNS, TCP, UDP, VLAN, HTTP, TLS, SIP, STUN, RTP, MWI, SDP, SRTP
DECT standard	DECT EN 300 175-x
Radio frequency range	1880–1900 MHz (Europe), 1910-1930 MHz (Latin America), 1910-1920 MHz (Brazil)
Transmission power	10 mW average power per channel, 250 mW pulse power
No. of channels	120 channels
Number of connections	simultaneous connections per base station (G.711), 8 simultaneous connections (G.729), 5 connections in wideband operation (G.722)
Range	Up to 300 m outdoors, up to 50 m indoors
Codec	G.711, G.722, G.729ab
Quality of Service	TOS, DiffServ

Technical data

Power adapter

Manufacturer	Salom Electric (Xiamen) Co. Ltd. Commercial registration number: 91350200612003878C 31 Building, Huli Industrial District, Xiamen, Fujian 361006, P.R. China
	LEADER ELECTRONICS Commercial registration number: 913211007039359372 8F, No.138 Ln. 235 Baoqio Rd. Xindian Dist. New Taipei City 23145, Taiwan
Model identifier	C706
Input voltage	230 V
Input AC frequency	50 Hz
Output voltage	12 V
Output current	1 A
Output power	12 W
Average active efficiency	> 83 %
Efficiency at low load (10%)	> 60 %
No-load power consumption	< 0.10 W

Index

A

Access code	39
Access data for LDAP server	75
Active Directory server	46
Additional attributes	80
Address of LDAP server	75
AND operator	78
Answer machine, playing back messages	74
Area code	69
local	40
prefix	40
Area codes	40
Attributes	
defining for display	80
in LDAP database	80
Attributes in the LDAP database	45
Attributes, LDAP	80
c	46, 80
cn	45, 80
company	45, 80
displayName	45, 80
facsimileTelephoneNumber	45, 80
friendlyCountryName	46, 80
givenName	45, 80
homePhone	45, 80
l	46, 80
mail	45, 80
mobile	45, 80
o	45, 80
ou	45, 80
postalAddress	46, 80
postalCode	46, 80
sn	45, 80
street	46, 80
telephoneNumber	45, 80
user-defined	46, 80
Audio quality	38
Authentication code for handset registration	31
Authorisation	85
Automatic search	81

B

Base station	5
events	64
BroadSoft XSL	41

C

c, attribute	46
Call	69
Call list, dialling from	70
Call manger, accepting call directly	34
Call on hold settings	26
Call swapping, two external calls	71

Call transfer settings	39
Call waiting, external	
accepting/rejecting	71
Calling	69
Calling party information	27
Care	86
Care of the device	86
Central phonebook	49
Certificate	38
web configurator	54
Certificates	56
CLI (Command Line Interface)	53
CLI access to the device configuration	53
cn, attribute	45, 80
Codecs	25
Column	
displaying/hiding	16, 66
Company directory	42
company, attribute	45, 80
Conference	72
Conference call	
end	72
two external calls	72
Connecting	
power cable	9
Connecting the PC to the web configurator	13
Connecting the power cable	9
Connecting to the LAN	9
Connection name	21
Consultation call	71
ending	71
Consumption of electricity, see Power consumption	
Contact with liquid	86
CSTA	
access data	34
CSTA (Computer Supported Telecommunications Applications)	27
CSV file, statistics	65
Customer Care	84

D

Data protection notice	10
Database access	75
Date	
setting	57
synchronisation	58
DECT	
radiation	61
security	61
DECT manager	5
LED display DECT traffic	11
DECT manager operation, incidents	66
DECT radio settings	62
DECT registration state	
handset	28

Index

DECT traffic	
DECT manager	11
Device button	7
DHCP server	18
Diagnostic	68
Diagnostics	
base stations	64
DECT manager incidents	66
Dialling	
from the call list	70
from the redial list	69
DiffServ (Differentiated Services)	38
Directories	
central phonebook	49
Directory	
accessing	73
attributes	80
configuring	42
configuring handset access	32
corporate	42
displaying attributes	80
name	75
opening	81
searching	82
using	73
XML format	47
Directory entry	
attributes	45
searching	82
Display format, LDAP	45
Display name, handset	28
displayName, attribute	45, 80
Disposal	85
DNS (Domain Name System)	19
DNS redundancy method	23
Domain name	75
Domain part of the user address	21
Download log files	66
Dump	68
E	
ECO DECT	61
Emergency reset	12
Environment	85
F	
facsimileTelephoneNumber, attribute	45, 80
Factory settings	60
Factory settings see Reset	11
Failed registration retry timer	37
Filter	77
criteria	77
format	77
name	79
number	79
Filter, LDAP	43
Firmware	
current version	58
handset	29
previous version	58
update	58
Firmware update	
LED display	11
scheduled	59
friendlyCountryName, attribute	46, 80
G	
G.711	26
G.722	26
enabling	38
G.729A	26
Gigaset DECT IP devices	4
Gigaset N670 IP PRO base station	5
givenName, attribute	45, 80
Global Catalog	46
Group pick-up	33
H	
Handset	6
belonging DECT manager	28
configuring mailbox access	33
DECT registration state	28
de-registering	31
directory assignment	32
display name	28
Firmware	29
LDAP authentication	33
menu	69
MWI settings	34
PIN for DECT registration	31
registering	28, 30
registration centre	35
settings	31
time-controlled registration	35
type	29
user name	28
VoIP account registration data	32
Handsets	
administration	28
registered	28
Help function, web configurator	15
homePhone, attribute	45, 80
Housing	
open	9
HTTP authentication	57
I	
Incidents	66
INT key	73
assigning directory	32
Integrator	
status	63

IP Address	
IPv4	18
IP address of LDAP server	75
IP address type	18
IP configuration	18
IPUI (International Portable User Identity)	28
IPv4	18
K	
Key synchronisation with BroadWorks	35
L	
l, attribute	46
LAN port	9
LAN slot	7
LAN synchronisation	
quality	65
Language, selecting for user interface	14
Language, user interface	
change	15
LDAP	
Active Directory	46
display format	45
name filter	44
number filter	44
search base	43
secure	43
LDAP attributes	45, 80
LDAP authentication for handset	33
LDAP directory	
configuring	42
name	42
server access data	42
LDAP filter	43
LDAP filter see Filter	
LDAP name	42
LDAP search base	76
LDAP server	
address	75
domain name	75
IP address	75
port	75
User ID	75
LDAP server scheme	45
LDAP server, URL	42
LED displays	7
LEDs	11
Liquid	86
List	
browse	17
filtering	16
sorting	16
Local area code	40
Local network	18
Local Time Server	57
Log file download	66
Log level	67
Logical operators see Operator	
M	
mail, attribute	45, 80
Mailbox configuration	33
Making calls	69
Medical equipment	84
Menu overview	
handsets	69
web configurator	17
MIB (Management Information Base)	67
Mobile devices	6
number	63
mobile, attribute	45, 80
Multicell system	4
MWI settings	34
N	
N610 IP PRO	4, 5
N670 IP PRO	4
N870 IP PRO	4
Name filter	77, 79
Name filter, LDAP	44
Navigation menu, show/hide	15
Network mailbox	
entering number	74
playing back messages	74
Network MB, see Network mailbox	
Network protocol	18
Non-SRTP calls, accepting	23
Number	45
Number filter	77, 79
Number filter, LDAP	44
O	
o, attribute	45
Online directory	
LDAP	42
name	46
public	46
server URL	47
XSI	47
Online services	50
Open housing	9
Open Source licenses	15
Operator	
AND	78
OR	78
OR operator	78
ou, attribute	45, 80
Outbound proxy mode	23
Outbound proxy port	24
Outbound server address	24

Index

P

Package content 8
 Password 75
 Password, web configurator 14
 changing 53
 PBX (VoIP) 6
 PBX access code 39
 PBX profile 21
 PCMA/ PCMU 26
 Phone number
 dialling 83
 Phone number in directory 80
 Phonebook, central 49
 backup 49
 deleting 49
 Place holder for user input 77
 PoE (Power over Ethernet) 9
 Port 75
 postalAddress, attribute 46, 80
 postalCode, attribute 46, 80
 Power adapter 84, 88
 Power cable slot 7
 Power consumption 87
 Power supply 9
 PRACK (Provisional Response
 Acknowledgement) 37
 Priority of voice data 38
 Profile 54
 deleting 27
 Profile, VoIP provider/PBX 21
 Provider profile 21
 Provisioning 54
 Provisioning server 55
 Proxy server
 address 22
 port 22
 Public online directory 46

Q

QoS (Quality of Service) 38

R

Radiation power 61
 Reboot
 LED display 11
 Redial list 69
 Registering a set of handsets 30
 Registering handsets 28, 30
 time-controlled 35
 Registering, with web configurator 14
 Registration centre 35
 Registration refresh time 22
 Repeater 5
 Reset 60
 emergency 12
 using the device button 11

Restore configuration 59
 Ringback
 switching function off if busy 70
 when the number is busy 70
 Ringtones, different 25
 RTP (Realtime Transport Protocol) 38
 RTP packetisation time (ptime) 26

S

Safety precautions 84
 Save configuration 59
 SDP (Session Description Protocol) 26
 Search base 76
 Search mode 82
 Search start point 76
 Secure LDAP 43
 Secure Real Time Protocol 23
 Secure Shell (SSH) 53
 Service 84
 SIP port 37
 SIP redundancy 23
 SIP server port 23
 SIP session timer 37
 SIP timer T1 37
 SISP 22
 sn, attribute 45, 80
 SNMP (Simple Network Management Protocol) 67
 SNMP manager 67
 Specifications 87
 SRTP options 23
 Standard gateway 19
 Statistics
 CSV file 65
 resetting 65
 Status information 63
 street, attribute 46, 80
 Subnet mask 19
 Subscription timer 37
 SysLog 67
 System backup 63
 System configuration 13
 System report (SysLog) 67

T

telephoneNumber, attribute 45, 80
 Time
 synchronisation 58
 zone 57
 Time server 57
 Time, setting 57
 Timer
 failed registration retry 37
 SIP session 37
 SIP timer T1 37
 subscription 37
 Tone scheme 40
 Transport protocol 22

<hr/>	
U	
Überblick	4
Update	58
user ID	75
User input, place holder	77
User name	
handset	28
web configurator	14
<hr/>	
V	
Voice quality	38
VoIP provider, configure profile	21
VoIP settings	37
<hr/>	
W	
Wall mounting	10
Wall mounting slots	7
<hr/>	
Web configurator	
applying/discarding changes	16
changing password	53
connecting with PC	13
logging in	14
logging off	15
menu overview	17
online help function	15
password	14
security certificate	54
starting	13
working with lists	16
<hr/>	
X	
XHTML	50
XSI (Xtended Service Interface)	41
XSI call log, enable	41
XSI directories	
enabling	41, 47
XSI services	
credentials	34

Issued by

Gigaset Communications GmbH
Frankenstr. 2a, D-46395 Bocholt

© Gigaset Communications GmbH 2021

Subject to availability.

All rights reserved. Rights of modification reserved.

www.gigasetpro.com