

Gigaset

N870 / N870E IP PRO

Multicell System

Installation, configuration and operation

Content

Gigaset DECT IP PRO devices – overview	5
N870 IP PRO Multicell System – Introduction	6
Components	6
N870 IP PRO installations	9
Planning your DECT wireless network	12
N870 IP PRO – overview	13
N870E IP PRO – base station with external antennas	15
First steps	18
Package content	18
Preparing to use the telephone system	18
Mounting the device	19
Installing the Integrator (large installation)	21
Defining the device role	22
Wall mounting	23
Operation hints	24
Light emitting diodes (LED)	24
Resetting base stations to factory settings via power procedure	25
Emergency reset to factory settings	26
Configuring the system	27
The web configurator	27
Web configurator menu overview	31
Network administration	33
IP and VLAN settings	33
DECT manager configuration	36
DECT manager administration	36
DECT manager registration	42
DECT manager synchronisation	42
Base stations	45
Base stations administration	45
Base station synchronisation	50
Provider and PBX profiles	65
Configuring provider or PBX profiles	65
Mobile devices	73
Mobile devices administration	73
Registering/de-registering handsets	75
Mobile devices – Registration Centre	81

Telephony settings	83
General VoIP settings	83
Audio quality	84
Call settings	85
XSI services	87
Online directories	88
Corporate online directories (LDAP)	88
Online directories in XML format	93
Online directories – XSI	94
Central phone book	95
Online services	97
XHTML	97
Application Server	98
System settings	100
Web configurator access rights	100
Licensing	102
Provisioning and configuration	103
Security	104
Date and time	106
Firmware	107
Save and restore	109
Reboot and reset	111
DECT settings	112
Diagnostics and troubleshooting	114
Status information	114
Base station events	115
Incidents	118
System log and SNMP manager	119
Diagnostics	121
DECT measurements	122
Migration	123
Using a handset connected to an N870 IP PRO base	124
Making calls	124
Accepting calls	125
Conversation with three participants	126
Message indication	127
Using directories	128
Using the network mailbox	129

LDAP directory – configuration example	130
Access to the LDAP server	130
Filters	132
Attributes	135
Display on the handsets	136
Appendix	139
Safety precautions	139
Customer Service & Help	139
Authorisation	140
Environment	141
Care	142
Contact with liquid	142
Technical data	143
Specifications	143
Accessories	144
Index	145

Gigaset DECT IP PRO devices – overview

Gigaset PRO DECT IP devices combine the possibilities of IP telephony with the use of DECT phones. They offer scalable telephone solutions for different company sizes and requirements.

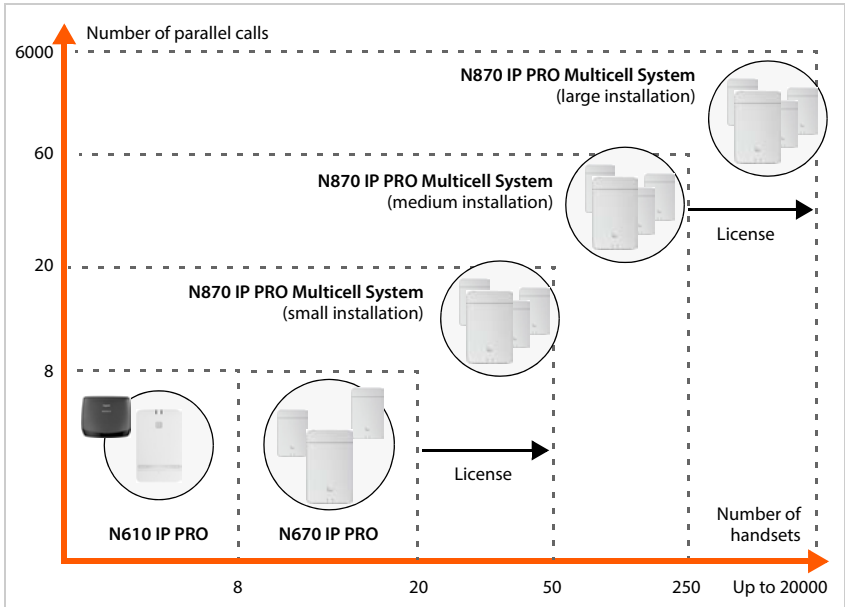

- N610 IP PRO** Single cell, 8 handsets, 8 simultaneous calls
Repeater support for range extension (up to 6)
- N670 IP PRO** Single cell, 20 handsets, 8 simultaneous calls
Mini multicell system operation with 3 base stations for range extension is possible.
Upgrade to a device in an N870 IP PRO Multicell System is possible via license key.
- N870 IP PRO** Multicell system
Small: 10 base stations, 50 handsets, 20 simultaneous calls
Medium: 60 base stations, 250 handsets, 60 simultaneous calls
Possible upgrade to a large system with up to 6000 base stations, 20000 handsets, 6000 simultaneous calls. Licenses are required for this.

N870 IP PRO Multicell System – Introduction

N870 IP PRO is a DECT multicell system for connecting DECT base stations to a VoIP PBX.



Units of the multi-cell system are available in two variants: N870 IP PRO with internal antennas and N870E IP PRO with external antennas (→ p. 15).

Components

The following illustration shows the components of the N870 IP PRO Multicell System:

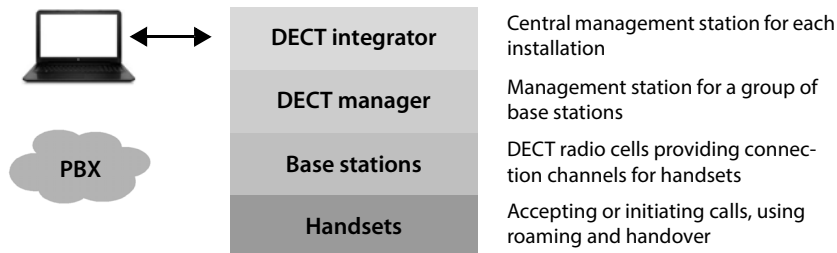

DECT integrator

Central management and configuration unit of the DECT multicell system.

The DECT integrator

- contains the central database for the DECT subscribers and base stations
- provides a web interface for configuring the entire cordless system
- enables access for configuration of all DECT managers and their base stations

DECT manager

Management station for a group of base stations. At least one DECT manager must be used in every installation.

The DECT manager

- manages synchronisation of the base stations within clusters
- acts as an application gateway between SIP and DECT signalling
- controls the media path from the phone system to the relevant base stations

Configuring DECT managers → p. 36

DECT base stations

- form the wireless cells of the DECT phone network
- provide media processing from the handsets directly to the phone system
- make available connection channels for the handsets (the number is dependent on various factors, such as bandwidth approved, → p. 11)

Configuring the base stations → p. 45

Handsets

- Many handsets are connected per DECT manager and many DECT calls can be held simultaneously (VoIP calls, and phone book or Info Centre accesses). Information on the functions of certain handsets on Gigaset base stations is available from wiki.gigaset.com.
- Subscribers can accept or initiate calls in all DECT cells with their handset (**Roaming**), and can also switch between the DECT cells during a call (**Handover**). A handover is only possible when the cells are synchronised.

Configuring handsets → p. 73

Detailed information about approved Gigaset handsets can be found in the relevant user guide. These are provided on the Internet at wiki.gigaset.com.

Phone system

Connect your DECT phone system to a VoIP phone system, e.g.:

- your own PABX (on-premise solution)
- a virtual phone system from an external provider (Cloud solution, hosted PBX)
- VoIP provider

The phone system

- establishes the connection to a public phone network
- enables central management of phone connections, directories, network mailboxes, ...

The DECT network

The DECT network comprises the overall radio area of the multicell system in which the users can make and receive calls using their handsets.

A specific DECT manager manages the whole or a part of the DECT network, one DM zone. It can comprise one or more clusters.

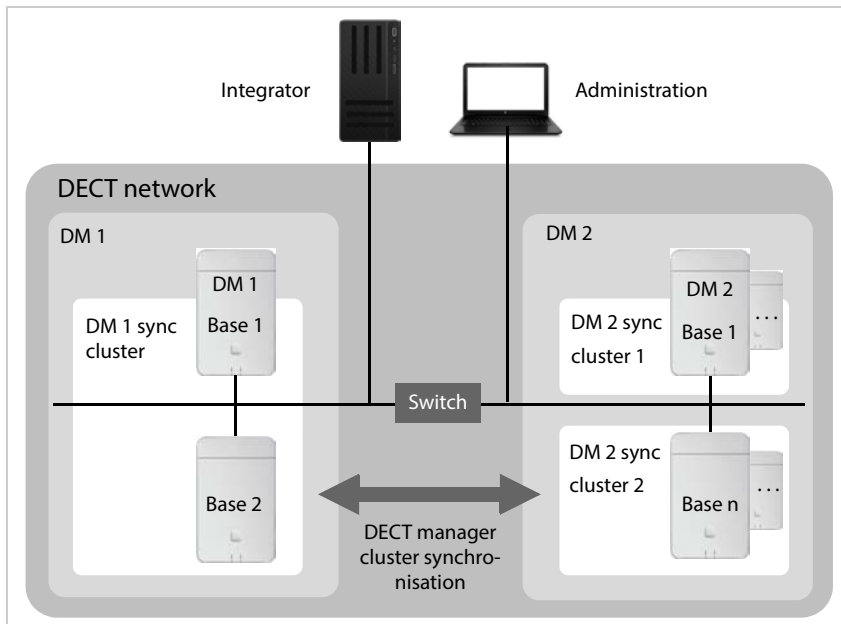

Clusters

A cluster defines a set of base stations of a DECT manager that shall synchronise in order to perform handover, roaming and overload balancing for handsets.

Handover A handset switches to a new base station during a call.

Roaming A handset in idle mode is connected to the DECT network via a new base.

Overload balancing A DECT connection (for a call or other administrative or customer purpose) is not set up at the current base station, which is fully loaded with active DECT or media connections, but via a neighbour base station, which has free resources to setup/accept the new DECT connection. Overload balancing is only possible inside a DECT manager zone.

Synchronisation

Handover and overload balancing can only be provided by synchronised base stations.

Base stations follow a common synchronisation source in order to synchronise within a cluster. This could be a base station of the cluster (sync level 1) or a common external synchronisation source (→ p. 50).

One DECT manager manages at least one cluster. In some cases, not all base stations connected to one DECT manager can be synchronised for location specific reasons. To organize synchronisation just within a subset of base stations connected to one DECT manager, a DECT manager can form multiple clusters (→ p. 50).

In multiple DECT manager installations, cross-cluster synchronisation is possible via DECT manager synchronisation (→ p. 42).

If the DECT connection between specific base stations seems to be not reliable enough, synchronisation can also take place via LAN (→ p. 51).

N870 IP PRO installations

Different build levels of the N870 IP PRO can be installed.

Small an medium installations

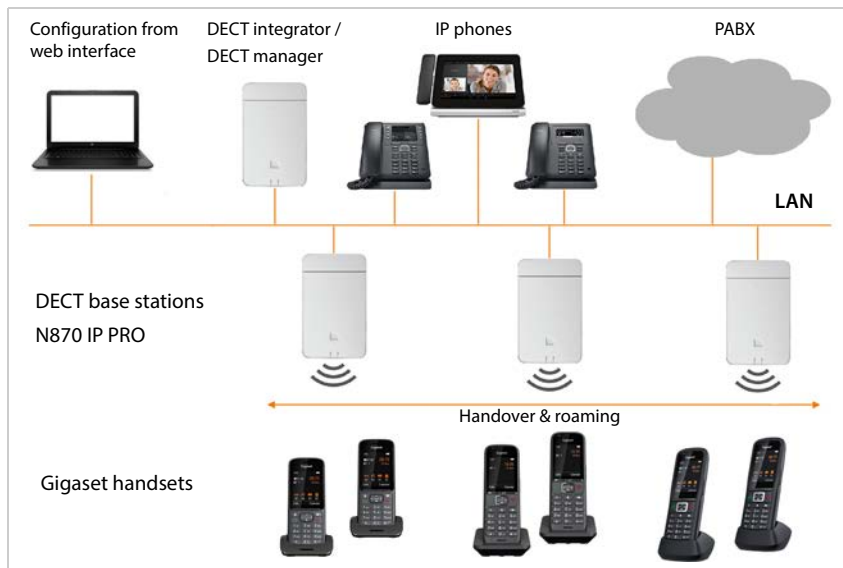

Small installations

- Integrator, DECT manager and a base station are together at the same device.
- Up to 9 further base stations can be managed.
- Up to 50 handsets can be registered.

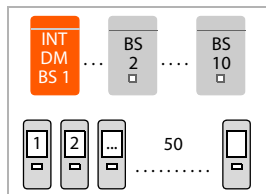

Medium installations

- Integrator and DECT manager are together at the same device. No base station is enabled at this device.
- Up to 60 base stations can be managed.
- Up to 250 handsets can be registered.

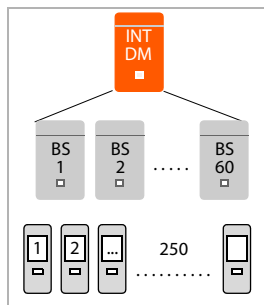

Large installations

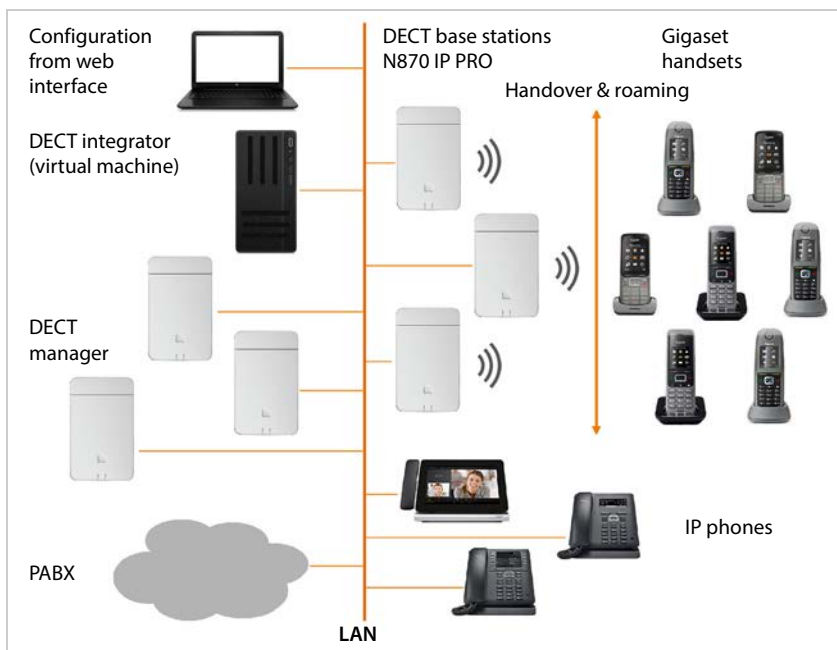

In a large installation the integrator is available as an own system component. An integrator is needed when:

- the system comprises more than 250 handsets
- you need more than 60 DECT base stations
- you want to manage more than one DECT manager via one web-interface
- you want to roam with the DECT handsets between multiple DECT managers/locations

Virtual integrator

- The integrator is available on a virtual machine.
- Up to 100 DECT managers can be used.
- Per DECT manager up to 60 base stations can be managed, 6000 in total.
- Up to 20000 handsets can be registered.

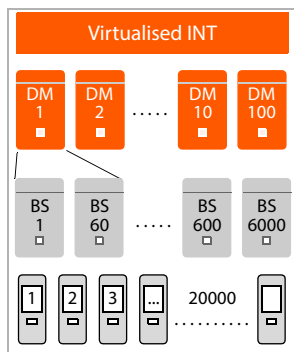

Device role: Integrator only

- The integrator is located alone at a device. No DECT manager or base station is enabled at this device.
- Up to 4 DECT managers can be used.
- Each DECT manager can manage up to 60 base stations, up to 240 base stations can be managed in total.
- Up to 800 handsets can be registered.

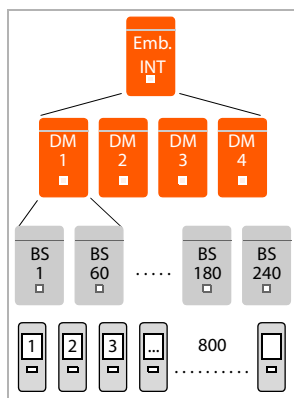

In case of a multi-DECT manager roaming installation, calculate some headroom for roaming visitor handsets. They cannot be load-balanced to other DECT managers.



For large installations you need a license key → p. 102.

Information on how to migrate from a small or medium configuration with one single DECT manager to a multiple DECT manager system → p. 123.

Number of parallel calls depending of device role

Base	10
Base + DECT manager	8
Base + DECT manager + Integrator	5

Number of parallel calls per base station depending on the selected codec: → p. 70

Planning your DECT wireless network

Careful planning of your DECT wireless network is the prerequisite for successful operation of the N870 IP PRO Multicell System with good call quality and adequate call options for all subscribers in all the buildings and areas belonging to the PBX. When deciding how many base stations are needed, and where these should be positioned, both the requirements for the capacity of the PBX and its wireless coverage, as well as many ambient conditions, must be taken into consideration.

Gigaset offers the DECT Site Planning Kit (SPK) PRO to help you measure the wireless coverage and signal quality on your DECT network. Information about setting up and using the Gigaset measuring equipment can also be found in the "DECT Site Planning Kit (SPK) PRO" Guide.

This Guide will make it easier for you to plan your multicell DECT network, explain the necessary preparatory work for the installation and describe how to carry out measurements in order to find the best positions for your base stations. Please read these instructions before starting installation.

N870 IP PRO – overview

Front



Device button

Set the device role; reset the device
→ p. 22

LED displays

Operation status of the device
→ p. 24

Top



LAN and power cable slot

Connecting the device → p. 19

Rear

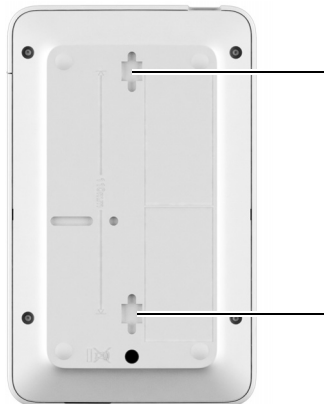

Wall mounting slots

Wall mounting → p. 23

N870E IP PRO

The Gigaset N870 IP PRO is also available as a variant with external antennas.



Antennas

Mounting the antennas → p. 15

N870E IP PRO – base station with external antennas

In contrast to the standard unit N870 IP PRO with two built-in internal wire antennas, N870E IP PRO offers the possibility to connect external antennas. For this purpose, the unit has two TNC connections.

Advantages of external antennas:

- Flexible adjustment and optimisation of antenna orientation can improve DECT range and save costs.
- Better handling of special environments: In situations where there are problems with DECT interference, changing the antenna position (by 45-90 degrees) can lead to an improvement.



N870E IP PRO units are supplied with two external antennas.

Mounting the antennas

- ▶ Mount the antennas on the threads on the left and right side of the device.

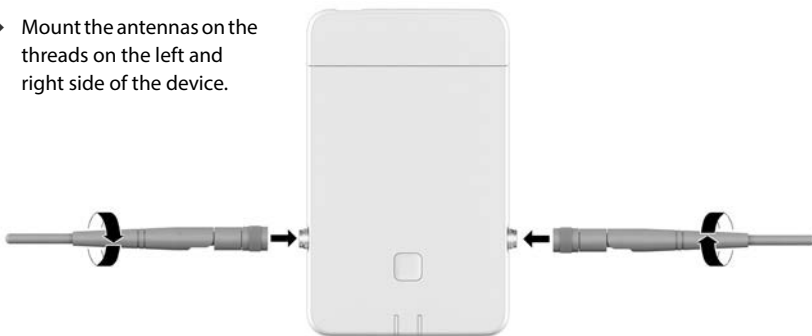

Aligning antennas

The movable, alignable antennas make it possible to improve the radiation direction of the DECT signal depending on the mounting orientation of the housing. However, the optimal alignment of the antennas can only be determined by a DECT measurement.

Observe the following notes:

- The strongest radiation from a dipole antenna is at right angles to the dipole.
- This stronger radiation should run directly into the room to be covered.
- This stronger radiation should not be reflected indirectly into the target room via a neighbouring metal surface, because this directivity does not apply to the detection of possibly colliding transmitters and thus this would create an imbalance between transmitter power and receiver sensitivity.

Third-party antennas

You can also use third-party antennas. They are intended for special tasks and conditions, e.g:

- in difficult environments: e.g. for mounting outdoors or cold storage, or similar.
N870E IP PRO can only be mounted indoors.
- in case of long distances: Use directional antennas that can cover a greater distance and channel DECT radiation to cover the area where DECT is needed more accurately.
- for aesthetic reasons: Use of an unobtrusive external antenna that matches the environment. The N870E IP PRO can then be installed invisibly.
- to increase the DECT range: mounting external antennas in a better position than would be possible with an N870E IP PRO base due to spatial conditions, (e.g. distance to LAN connection).



Gigaset has selected and tested a number of third-party antennas. You can find recommendations at wiki.gigaset.com.

Notes on the use of third-party antennas

Suitable antennas

- The antenna connection must be of the TNC type.
- Only use antennas of the same type.
- Use the same length of cable on both sides.
- Do not mount one antenna inside and the other outside.
- Be sure to connect two antennas (antenna diversity).
Antenna diversity is one of the strongest means against unwanted reflections in a duplex connection between handset and base. If you connect only one antenna, this remedy is over-ridden.

Use of directional antennas

- Neighbouring base stations must receive signals from each other to optimise channel selection. Using two neighbouring N870E IP PRO base stations with directional antennas connected and pointing in different directions can therefore be problematic.

Field strength

- The operation of external antennas must not exceed the legal limits of permissible field strength. Check your regional regulations. If in doubt, you can reduce the transmit power in the Web configurator via the **Reduce transmitting power for external antenna operation** option for this unit (➔ p. 49).
- When calculating the total antenna gain, take into account that the coaxial cable causes additional attenuation that must be considered.

Cable

In addition to the antennas, you need pre-assembled coaxial cables with the following characteristics:

- a TNC plug for the DECT base on one side
- on the other side an SMA plug for indoor antennas or an N-standard plug for outdoor antennas (plug depends on the external antenna model)
- Length: 5m - 10m, diameter: 5mm

Make sure you tighten the screws on both sides

Using N870E IP PRO together with N870 / N870E IP PRO

N870E IP PRO is based on the same hardware and software and has the same feature set as N870 IP PRO, except for the external antenna equipment.

This means:

- N870E IP PRO can be used together with N870 IP PRO in the same DECT network.
- N870E IP PRO can have all device roles available for N870 IP PRO.
- N870E IP PRO can have all licences that can be applied to N870 IP PRO.

First steps

Package content

- One N870 IP PRO or N870E IP PRO
A device can play different device roles in the N870 IP PRO Multicell System (→ p. 9)
- Security leaflet
- Screws and wall plugs for wall mounting

Only for N870E IP PRO:

- Two antennas



The N870 IP PRO devices are powered by Power over Ethernet (PoE). If you do not use an Ethernet switch with PoE functionality and require a power adapter to connect to the mains power supply, you can order this as an accessory (→ p. 144).

Preparing to use the telephone system

To use the telephone system the following steps must be performed:

- 1 Perform DECT measurement and site planning
During the planning phase of your DECT network you should have created an installation plan for the DECT managers and base stations.
- 2 Connect the devices to the local network → p. 20
- 3 **In small and media installations:**
Configure one device as Integrator/DECT manager → p. 22
In large installations:
Set-up the virtual machine for the Integrator → p. 21
Configure the DECT manager stations and register them on the Integrator → p. 22
- 4 Mount the devices at the planned locations → p. 23
Note: For each location please note down the MAC address of the device you are going to install.
- 5 Configure the local network settings via web configurator → p. 33
You need a PC connected to the local network, so that you can configure your telephone system via the web configurator.
- 6 Perform a firmware update → p. 107

- 7 In case of a multi-DECT manager installation, register the DECT managers at the Integrator → p. 36
 - 8 Register the base stations at the DECT manager → p. 45
- Note:** The base stations will go offline for the duration of firmware update. Further configuration of base stations (step 9) could be done via the Integrator Web-UI (and database). But the base stations cannot learn new settings, until they have finished their offline status in case of a firmware update.
- 9 Configure the base station synchronization → p. 50
 - 10 Configure VoIP or provider → p. 65
 - 11 Register handsets and perform handset configuration

All the handsets to be used for making calls over the N870 IP PRO must be registered at the telephone system. Any handset must get assigned an individual SIP account at the SIP. When registering, the handset is permanently assigned a VoIP connection as the receive and send connection.

Create a backup to save your configuration



If you want to migrate from a small or medium configuration with one single DECT manager to a multiple DECT manager system, please read the "Migration" chapter first (→ p. 123).



Whenever there are new or improved functions for your Gigaset device, firmware updates are made available for you to download to your DECT managers and your base stations. If this results in operational changes when using your phone, a new version of this user guide or the necessary amendments will be published on the Internet at

wiki.gigaset.com

Select the product to open the relevant product page for your device, where you will find a link to the user guides.

To find out which version of the Integrator/DECT manager firmware is currently loaded, see → p. 107 and/or p. 114.

Mounting the device



For useful information on DECT radio coverage and the resulting optimum installation please refer to the "DECT Site Planning Kit (SPK) PRO" Guide.

- When installing the base stations, please take into account the technical conditions for positioning and the installation guidelines, which are described in the "DECT Site Planning Kit (SPK) PRO" Guide.
- Install the base stations at the positions you determined when planning or measuring your DECT wireless network.

- The N870 IP PRO device acting as Integrator/DECT manager can be installed anywhere within the range of the local network. It does not need to be installed in the coverage area of the DECT wireless network. Exception: the device comprising the DECT manager also acts as base station.
- The N870 IP PRO devices are intended for wall mounting (→ p. 23).



- The N870 IP PRO is designed for use in dry rooms with a temperature range of +5°C to +45°C.
- Never expose the N870 IP PRO to heat sources, direct sunlight or other electrical appliances.
- Protect your device from moisture, dust, corrosive liquids and fumes.

Connecting to the LAN



DECT manager and base stations must be connected to the same Ethernet or virtual LAN sharing a common broadcast domain.

If you intend to use DECT-LAN synchronisation, please consider the requirements mentioned in section "LAN-based synchronisation along the synchronisation path" (→ p. 51).

You can connect the N870 IP PRO to your local network via a router or switch. A VoIP PBX is required for Internet telephony. This must be accessible via the local network and must have network access.

You also need a PC connected to the local network, so that you can configure your telephone system via the web configurator.

For each device to be connected to the local network an Ethernet cable is required.



- ▶ Pull up the upper part of the housing and fold it forwards **1**.
- ▶ Insert a plug from an Ethernet cable into the LAN connection socket at the top of the device **2**.
- ▶ Insert the other Ethernet cable plug into a LAN socket for your local network or on the PoE switch **3**.
- ▶ Close the flap.



Data protection notice

Once the device is connected to the Internet, it automatically contacts the Gigaset support server to make it easier for you to configure the devices and to enable communication with Internet services.

For this purpose, the system sends the following information when it is started and then every five hours:

- Serial number/item number
- MAC address
- Device name
- License information
- Software version

The following data is transmitted once every day:

- Number of registered handsets
- Number of connected base stations
- Number of connected DECT managers
- Information for each handset: DECT identifier (IPUI), device type, user name and display name

On the support server, this information is linked to the existing device-specific information:

- System-related/device-specific MAC address - MAC address password

Connecting the power supply



Your N870 IP PRO is supplied with sufficient power via PoE (Power over Ethernet) if the device is connected to an Ethernet switch with PoE functionality (PoE IEEE802.3af class 1). In this case, you do **not** need to connect the device to the mains power supply.

Installing the Integrator (large installation)

The virtual integrator appliance could be offered as

- *.zip archive consisting of one *.vmx file specifying the virtual machine configuration and some virtual disk images (*.vmdk) for this virtual machine

or

- single *.ova file, into which the VM configuration and the virtual disk-images files are compiled.

The virtual integrator is designed for and tested with VM Spehre ESXi (Versions 5.5, 6.0 and 6.5). With its low requirements, the virtual integrator appliance might be supported by many other hypervisor solutions, which are not mentioned here.

Defining the device role

On delivery all N870 IP PRO devices are configured as base station. To set up the DECT multicell system at least one device must be configured as **All in one** device. Detailed information on device roles → p. 6.

You can use the device button on the front side to change the role of the device. The following settings are possible:

- **Base station**
- **All in one** (integrator/DECT manager/base station) with dynamic IP settings
- **All in one** (integrator/DECT manager/base station) with fixed IP settings
- **DECT manager and base station**

All other roles must be set via the web configurator.

Selecting the role

- ▶ Press the device button for at least 10 seconds until all LED switch off ... the device is now in programming mode.



Base station:

- ▶ Release the button ... the right LED lights green.



All in one with dynamic IP settings:

- ▶ Short press the device button until both LED light blue. ... The IP address will be assigned by a DHCP server in your network.



All in one with fixed IP settings:

- ▶ Short press the device button until the right LED lights blue. ... The following IP settings are set:
IP address: 192.168.143.1
Subnet mask: 255.255.0.0



DECT manager and base station:

- ▶ Short press the device button until the left LED lights blue and the right LED lights green.



This role is only needed in combination with a virtual/embedded Integrator.

Saving the selected role

- ▶ The selected role is automatically assigned to the device, when the button is pressed for four seconds ... both LED light red. The device is reset and rebooted (this can take up to 5 minutes).





When changing the device role the system is reset to factory setting. This means, that existing configuration and user data will be lost.

If you change the role of a device that has been acting as Integrator, you should save the configuration previously.

If you intend to reset the role from base to base/DECT manager:

Before you switch the device role, previously delete the base at any other system where it was registered before. Otherwise problems may occur because the device might be bound to two concurrent systems.

Wall mounting

N870 IP PRO is intended for wall mounting. After connecting the LAN cable and setting the device role you can place it to the destined location.

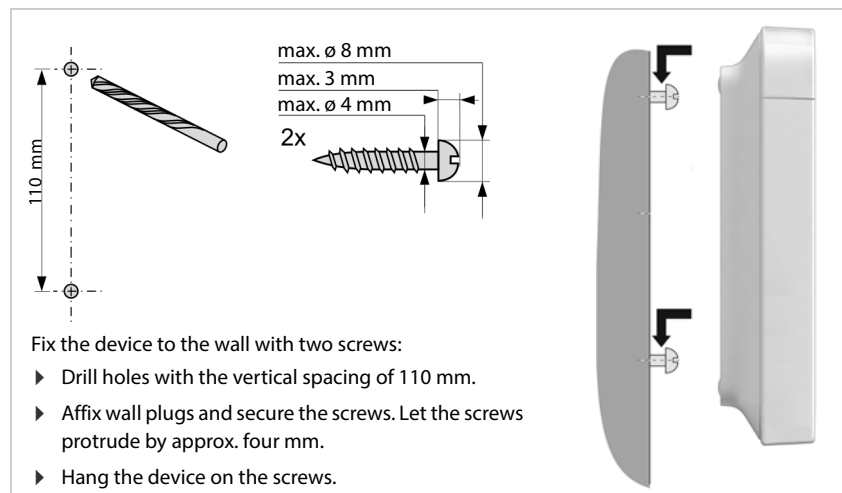

Operation hints

Light emitting diodes (LED)

Depending on the device role the LEDs on the front side show different operational states. The LEDs can have three different colours (red, blue, green) or can be off.



LED status display for base stations can be disabled (→ p. 47).

DECT manager and base stations

LED 1 (left)				LED 2 (right)				Description
0.5 s	0.5 s	0.5 s	0.5 s	0.5 s	0.5 s	0.5 s	0.5 s	
[Grey]				[Grey]				Power off
[Red]				[Red]				Device is booting
[Blue]		[Grey]		[Grey]		[Blue]		Firmware update in progress
[Red]		[Grey]		[Grey]		[Red]		No connection to LAN or no IP address available/assigned
[Green]		[Grey]		[Grey]				Connecting to DECT manager or no connection to DECT manager

Base station operational states

LED 1 (left)				LED 2 (right)				Description
0.5 s	0.5 s	0.5 s	0.5 s	0.5 s	0.5 s	0.5 s	0.5 s	
[Green]				[Grey]				Successful connection to DM, synchronising
[Green]				[Green]				Synchronised, DECT ready
[Green]				[Green]		[Grey]		Synchronised, DECT or RTP traffic
[Green]				[Green]	[Grey]			Synchronised, DECT or RTP overload

DECT manager (without DECT)

LED 1 (left)				LED 2 (right)				Description
0.5 s	0.5 s	0.5 s	0.5 s	0.5 s	0.5 s	0.5 s	0.5 s	
[Blue]				[Grey]				No DECT base inside active
[Blue]			[Grey]	[Grey]				System traffic / ongoing calls

DECT manager (with DECT)

LED 1 (left)				LED 2 (right)				Description
0.5 s	0.5 s	0.5 s	0.5 s	0.5 s	0.5 s	0.5 s	0.5 s	
								Not synchronised, DECT ready
								Synchronised, DECT ready
								Synchronised, system traffic, no DECT traffic
								Synchronised, DECT or RTP traffic
								Synchronised, DECT or RTP overload
								Depending on traffic state
								Connection to the Integrator lost

Resetting base stations to factory settings via power procedure

The following describes the procedure to reset base stations to factory settings via power procedure. You can use it, if it is not possible to reset the device

- via the web configurator (→ p. 111), for instance because you have forgotten the password for the web configurator or you are experiencing problems accessing the LAN
- via the key procedure (→ p. 22), for instance because the devices are mounted in a place that is difficult to access.



The following procedure only applies to base stations. For DECT manager/Integrator you need to use one of the above procedures.

Resetting the device to factory settings is performed by interrupting the boot process.

- ▶ Remove the power supply from the device (unplug the LAN cable or the power supply unit).
- ▶ Replug the LAN cable or the power supply unit ... the reboot starts. If the boot process is not interrupted, the standard reboot is performed.
- ▶ Interrupt the boot procedure after 30 sec. at the earliest and 40 sec. at the latest.

Two times	The device is reset as base station.
Four times	The device is reset as Integrator/DECT manager/base station with dynamic IP settings.



This procedure resets all the settings you have made for the device. The procedure deletes the saved data from the base stations and handsets. The base station's assignment to the DECT manager is cancelled. Ongoing calls are cancelled. In the case of an Integrator/DECT manager the whole configuration is reset.

To enable the restoration of your system configuration after a reset, you should regularly save the configuration data to a file (→ p. 109).

If you intend to reset the role from base to DECT manager/base station, previously delete the base at any other system where it was registered before.

Emergency reset to factory settings

When the device is booting

- ▶ Press the device button for at least 10 seconds until all LED switch off ▶ release the button . . . the device is now in programming mode.
- ▶ Press the device button until
 - both LED light blue: for Integrator/DECT manager with dynamic IP settings
 - the right LED lights blue: for Integrator/DECT manager with fixed IP settings
 - the right LED lights green: for Base station
 - the left LED lights blue and the right LED lights green: for Base station and DECT manager
- ▶ Press the device button for at least four seconds . . . the device is reset and rebooted.

Configuring the system

System settings are made via the web configurator of the N870 IP PRO and cannot be changed using the handsets.

This applies in particular for:

- Registering and de-registering the handset at the telephone system, handset name.
- All settings for the VoIP account used by a handset for calls.
- Configuration of online directories.

Handset-specific settings are preset on your handset. You can change these settings.

This applies, for example, for

- Display settings, such as language, colour, backlight etc.
- Settings relating to ringtones, volume, speaker profiles etc.

Information about this can be found in the user guide for the relevant handset.

The web configurator

Use the web configurator to set up your N870 IP PRO and configure your DECT network.

- Set up the DECT network, register and synchronise the base stations.
- Make basic settings for the VoIP connections and register and configure the handsets you wish to use in the DECT network.
- Make additional settings, e.g., meet particular prerequisites for connecting the handsets to a corporate network or adjust the voice quality on VoIP connections.
- Save data required to access specific services on the Internet. These services include access to online directories, as well as synchronising the date/time with a time server.
- Save your DECT network's configuration data as files on your PC and reload these in the event of an error. Upload new firmware, if available, and plan firmware updates at a specific date.

Starting



At least one N870 IP PRO device is installed as Integrator/DECT manager (→ p. 22).

A standard web browser is installed on the PC/tablet.

The device housing the Integrator/DECT manager and the PC/tablet are directly connected to one another in a local network. The settings of any existing firewall installed on your PC allow the PC/tablet and Integrator/DECT manager to communicate with each other.



Depending on your VoIP PBX/VoIP provider, it is possible that you will be unable to change individual settings in the web configurator.

While you are connected to the web configurator, it is blocked to other users. Simultaneous access is not possible.

- ▶ Launch the web browser on your PC/tablet.

- ▶ Enter gigaset-config.com in the address field of the web browser
If several Gigaset devices can be reached at this address, a list is displayed ▶ Select device ... the N870 IP PRO web configurator is started

or

- ▶ Enter the current IP address of the Integrator/DECT manager in the address field of the web browser (for example: <http://192.168.2.10>).

IP address of the device

If the IP address is assigned dynamically via your local network's DHCP server, you can find the current IP address on the DHCP server in the list of registered DHCP clients. The MAC address can be found on the rear of the device. If necessary, contact the network administrator for your local network.

Your DECT manager's IP address may change occasionally depending on the DHCP server settings (⇒ p. 33).

Logging into/off the web configurator

Once you have successfully established the connection, the login screen is displayed in the web browser. There are two user roles with different user IDs:

- admin** has unlimited access to all functions of the web configurator.
- user** has only limited access to some settings and system information, e.g., handset registration and some system settings. The **user** role must be activated before it can be used (⇒ p. 100).

- ▶ Enter the user ID in the **Username** text field (**admin/user**).
- ▶ Enter the password in the **Password** text field. Default **admin/user**
- ▶ From the options menu **Language** select the desired language.
- ▶ Click on **Login**.

Logging in the first time

You will be asked to change the default password and to set the appropriate radio frequency band.

- ▶ Enter a new password in the **New password** field and repeat it in the **Repeat password** field
The password must contain:
 - at least one upper-case character
 - at least one number
 - at least one special character
 - from 8 to 74 characters
- ▶ Select the radio frequency band used in your region from the list (⇒ p. 113).
- ▶ Click on **Set** to save the settings and to open the administrator interface.



If you do not make any entries for a lengthy period (approx. 10 minutes), you are automatically logged off. The next time you try to make an entry or open a web page, the login screen is displayed again. Enter the password again to log back in.

Any entries that you did not save on the telephone system before automatic logoff will be lost.

Logging off

You will find the log off function at the top right of each web page, below the product name.

- ▶ Click on  Logout



The session is automatically terminated after ten minutes of inactivity.

Always use the logout function to end the connection to the web configurator. If, for example, you close the web browser without logging off beforehand, access to the web configurator may be blocked for a few minutes.

Changing language

You can change the language at any time.

- ▶ From the option menu  Language ▼ at the top right of any web page select the desired language.

Licence terms

The login screen provides information on the open source software included in the product.

- ▶ In the lower right corner of the login screen click on **Licence terms**.

Showing/hiding the navigation menu

On each web configurator page a side menu on the left allows you to navigate through the available functions. The menu currently used is unfolded and the currently selected menu entry is coloured orange.

The navigation menu can be displayed permanently or can be hidden in the case the pointer is moved out of the menu area.

- ▶ Use the **Auto-hide menu** check box beneath the menu list to show/hide the menu.



unchecked

The navigation menu is shown permanently. (Default)



checked

The menu is hidden as soon as you move the pointer out of the menu area. Only the upper menu level symbols are shown on the left.

To re-display the menu: ▶ Move the pointer to the area the menu symbols are shown.

Help function





Parameter description

- ▶ Click on the question mark next to the parameter for which you need information. A popup window is opened displaying a short description for the selected parameter.

Function description for the entire web configurator page

- ▶ Click on the question mark in the upper right corner of the page. The online help is opened in a separate window. It provides information about the functions and tasks that can be performed via this page.

You have access to the total online help:

- Browse through the online help: ▶ Use the   buttons.
- Open the table of contents: ▶ Click on the  button.
- Open the index to search for specific keywords: ▶ Click on the  button.

Applying/discarding changes

Applying changes

- ▶ Select the **Set** button as soon as you have completed your change on a page ... the new settings are saved and activated in the configuration.



Changes that have not been saved are lost if you move to another web page or the connection to the web configurator is lost, e.g., due to exceeding the time limit (→ p. 29).

Discarding changes

- ▶ Select the **Cancel** button ... changes made on the web page are rejected and the settings that are currently saved in the telephone system configuration are reloaded.

Working with lists

Changing the appearance of the list

Filtering the list:

- ▶ Enter a search item (full field content) in the text field ... only entries containing text matching the search item in any column are shown in the table.

Filtering the list by column content:

- ▶ In the **Search in** option menu select the columns which should be searched for the entered search item ... only entries containing text matching the search item in the selected column are shown in the table.

Sorting the list:

- ▶ Click on the arrows next to the column header to sort the table on the column content in ascending or descending order.

Displaying/ hiding columns:

- ▶ Click on the **View** option menu on the right ▶ Select the columns you want to be displayed in the table (👁 / 🚫 = displayed/hidden).

Names of columns which cannot be hidden are greyed out.

Changing the number of list entries

- ▶ On the right side below the list select the maximum number of entries that should be displayed on a page (10, 25, 50, 100).

Browsing through the list

If there are more list entries than the selected number, you can browse through the whole table page by page. The number of pages is shown below the list. The current page is highlighted.

- ▶ Click on **Previous** or **Next** to scroll through the list page by page.
- ▶ Click on a specific page number, to go to the desired page directly.

Web configurator menu overview

Menu options that are available also in the DECT managers user interface are highlighted grey. The other options are available only on the Integrator.

Settings	Network	IP/LAN	→ p. 33
	DECT Manager	Administration	→ p. 36
		Synchronisation	→ p. 42
	Base stations	Administration	→ p. 45
		Synchronisation	→ p. 50
	Provider or PBX profiles		→ p. 65
	Mobile devices	Administration	→ p. 73
		Registration Centre	→ p. 81
	Telephony	Audio	→ p. 84
		Call settings	→ p. 85
		VoIP	→ p. 83
		XSI Services	→ p. 87
	Online directories	Corporate	→ p. 88
		XML	→ p. 93

	XSI	→ p. 94
	Central phonebook	→ p. 95
Online services	XHTML	→ p. 97
	Application Servers	→ p. 98
System	Web configurator	→ p. 100
	Licencing	→ p. 102
	Integrator Config	→ p. 42
	Provisioning and configuration	→ p. 103
	Security	→ p. 104
	System log	→ p. 119
	Date and time	→ p. 106
	Firmware	→ p. 107
	Save and restore	→ p. 109
	Reboot and reset	→ p. 111
	DECT settings	→ p. 112
Status		→ p. 114
Overview	Base stations	→ p. 115
Statistics	Incidents	→ p. 118
	Diagnostics	→ p. 121
	DECT measurements	→ p. 122



The **user** role has only restricted access to the user interface. If you login as **user**, most of the menus entries are hidden.

Network administration

IP and VLAN settings

This page is used to integrate the DECT multicell system into your company's local network. It is available in the Integrator and DECT manager user interface for the user role **admin**.

▶ **Settings** ▶ **Network** ▶ **IP/LAN**



If you change the IP address of the device or an error occurs when you are changing the IP settings, the connection to the web User Interface may be lost.

IP address changed: ▶ Re-establish the connection with the new address.

An error occurred: ▶ Reset the device to the factory settings.

→ p. 25

Device name in the network

▶ Enter a label for the device. It is used to identify the device in network communication.

Address assignment

Network type

▶ Select the IP protocol used in your local network: Currently only **IPv4** is supported.

IP address type

▶ Select **Dynamic**, if your device receives the IP address via a DHCP server.

▶ Select **Static**, if you want to assign a fixed IP address to the device.

If the **Dynamic** setting is selected, all further settings are automatically configured. They are displayed and cannot be changed.

If you have selected **Static** as the address type, you must create the following settings.

IP address

▶ Enter an IP address for your device. This IP address allows your device to be reached by other subscribers in your local network.

The IP address comprises four individual groups of numbers with decimal values from 0 to 255 that are separated by a dot, e.g., 192.168.2.1.

The IP address must be included in the address block used by the router/gateway for the local network. The valid address block is defined by the IP address for the router/gateway and the **Subnet mask**.



The IP address must be unique across the network, which means that it must not be used by another device connected to the router/gateway.

The fixed IP address must not belong to the address block that is reserved for the DHCP server for the router/gateway.

Check the settings on the router or ask your network administrator.

Subnet mask

The Subnet mask specifies how many parts of an IP address the network prefix must comprise. For example, 255.255.255.0 means that the first three parts of an IP address must be the same for all devices in the network, while the last part is specific to each device. In subnet mask 255.255.0.0, only the first two parts are reserved for the network prefix.

- ▶ Enter the subnet mask that is used by your network.

Standard gateway

The Standard gateway is generally the router/gateway of the local network. Your Integrator/DECT manager device requires this information to be able to access the Internet.

- ▶ Enter the local (private) IP address for the standard gateway through which the local network is connected to the Internet (e.g., 192.168.2.1).

Preferred DNS

DNS (Domain Name System) allows you to assign public IP addresses to symbolic names. The DNS server is required to convert the DNS name into the IP address when a connection is being established to a server.

- ▶ Enter the IP address for the preferred DNS server. You can specify the IP address for your router/gateway here. This forwards address requests from the Integrator/DECT manager to its DNS server. There is no default setting for a DNS server.

Alternate DNS

- ▶ Enter the IP address for the alternate DNS server that should be used in situations where the preferred DNS server cannot be reached.

VLAN

Details in this area are only required if you connect your phone system to a local network that is divided into virtual subnetworks (VLAN – Virtual Local Area Network). In a tagged VLAN, data packets are assigned to the individual subnetworks via tags (markings) that consist of a VLAN identifier and the VLAN priority, amongst others.

You will need to save the VLAN identifier and VLAN priority on the phone system configuration. Your VLAN provider will supply you with this data.

VLAN tagging

- ▶ Select the check box next to **VLAN tagging**, if you want the phone system to use VLAN tagging.

VLAN identifier

- ▶ Enter the VLAN identifier that uniquely identifies the subnetwork. Value range: 1–4094.

VLAN priority

The VLAN priority allows voice data transport to take priority, for example.

- ▶ From the option menu select the priority for the phone system data.
Value range: 0–7 (0 = lowest, 7 = highest priority; Default = 6)



Ensure that the details in **VLAN identifier** or **VLAN priority** are set correctly. Incorrect settings can cause problems when connecting the device for configuration purposes.

If required, you must carry out a hardware reset via device button (→ p. 24). This means that all settings are lost.

DECT manager configuration

DECT manager configuration is only necessary in large installations with more than one DECT manager. It is only available on the Integrator user interface.

To configure the DECT managers of your multicell system

- Create a list of DECT managers with identifier on the administration page
- Log in to the DECT manager devices and register the DECT managers at the Integrator
- Set up the DECT manager synchronisation, if applicable

DECT manager administration

The page allows you to manage the DECT managers of your multicell network.

It is only available in the Integrator user interface for the user role **admin**.

► **Settings** ► **DECT Manager** ► **Administration**

The page shows the following information for the DECT managers that are registered at the Integrator:

DM Id	DECT manager identification within the multicell system.
DM Name	Name of the DECT manager. It can be edited.
Backup for	The column is inserted if the unit acts as a backup system for DECT Manager redundancy. It contains the name of the DECT manager for which the backup is set up (master DECT manager).
RPN Group	Part of the RFPI for a DECT manager. PARI and RPN must be locally unique in order to achieve that the RPN group allocated for the base stations of a DECT manager is locally unique in the system too.
PMID / TPUI Group	DECT manager specific handset group. It is assigned automatically, when the DECT manager is added to the system. PMID (Portable part MAC IDentity) uniquely identifies an active handset connection. Assigned individual TPUI uniquely identifies a handset. Assigned PMID is derived from the assigned TPUI. The column is hidden by default.
IP address	IP address of the DECT manager. ► Click on  to open the web user interface of the related DECT manager.
Connection status	Shows whether the DECT manager is currently connected to the multicell system or not (Connected / Not connected).
Bases	Number of base stations located at this DECT manager.
Handsets	Number of handsets assigned to the DECT manager.

Capacity	The value indicates how many base stations, handsets and calls can be handled by the DECT manager. It depends on the activation of the local base of this DECT manager (→ p. 9). Medium The local base of this DECT manager is deactivated. The capacity is 60 external base stations, 250 handsets, 60 calls. Small The local base of this DECT manager is activated. The capacity is 9 external base stations, 50 handsets, 10 calls. The actual values are shown in the Bases limit , Handsets limit and Calls limit columns.
Bases limit	Maximum number of base stations that are allowed to be assigned to the DECT manager. The column is hidden by default.
Handsets limit	Maximum number of handsets that are allowed to be registered at the DECT manager. The column is hidden by default.
Calls limit	Maximum number of calls that are allowed to be active simultaneously. The column is hidden by default.
New calls blocked status	Indicates whether the Block new calls service is activated or not.
New calls blocked from	Start time of call blocking, if Block new calls service is activated.
New calls blocked duration	Duration of call blocking, if the Block new calls service is activated.

Global settings (only on a virtual integrator)

A license is based on a MAC address. As the virtual integrator is not a physical device, you need to define a master DECT manager for licensing.

- ▶ From the **Master DECT Manager** option menu select a DECT manager as master.

Actions

Blocking calls

For each DECT manager you can define a period of time in which all calls are blocked.

- ▶ Mark the check box next to the DECT manager you want to configure. Multiple choice is possible.

Detailed information → p. 41

Adding a DECT manager to the list

Before you can integrate N870 IP PRO devices as DECT managers into your multicell system, you first have to create a list of DECT managers on the administration page.

- ▶ Click on **Add** ... the DECT manager page is opened.

Deleting a DECT manager from the list

- ▶ Select the check box next to the DECT manager you want to delete. Multiple choice is possible. ▶ Click on **Delete** ▶ Confirm with **Yes** ... all selected DECT managers are deleted.



Before you delete a DECT manager, first consider what to do with the base stations assigned to it. You could export them in order to import them into another configuration. You could delete them from this DECT manager in advance.

Editing the data of a DECT manager

- ▶ Click on  next to the DECT manager you want to edit ... the DECT manager configuration page is opened.

Setting up a DECT manager as backup system for DECT manager redundancy

Only available for a virtual integrator managing multiple DECT managers.

- ▶ Select the master DECT manager for which you want to set up a backup system ▶ Click on **Add backup DM** ... the page for setting up the backup DECT manager is opened.

Adding/editing a DECT manager

On this page you enter the data for a DECT manager to be added to the multicell system or edit the data for a DECT manager that is already assigned to the multicell system.

It is only available in the Integrator user interface for the user role **admin**.

DM Id

DECT manager identification within the multicell system. It is assigned automatically. The identity must be used when registering the DECT manager at the Integrator.

After the DECT manager has been added, you should note this identifier to have it available, when you will have to enter the account data later at the DECT manager.

DM Name

The name is used to identify the DECT manager within DECT manager lists.

- ▶ Enter a meaningful name for the DECT manager, e.g., referring to the location or organisational unit.

Password

The password must be entered when registering the DECT manager at the Integrator.

- ▶ Enter a password for DECT manager registration.

You should note this password to have it available, when you will have to enter the account data later at the DECT manager.

RPN Group

Part of the RFPI for a DECT manager. PARI and RPN must be locally unique in order to achieve that the RPN group allocated for the base stations of a DECT manager is locally unique in the system too.

- ▶ Select the RPN group number for the DECT manager from the option menu. Values: 0 – 3

Four RPN groups imply that there are potentially eight neighbours for a DECT manager. Neighbouring DECT managers must not have the same RPN group.

Example:

RPN groups of neighbouring DECT managers		
0	1	0
2	3	2
0	1	0

To ensure, that a handset in 3 cannot see two identical RPN from the left 2 and the right 2 area, it is necessary, that any DECT manager coverage area in any direction is large enough, to provide enough isolation between two DECT manager areas of the same RPN group.

Example: Any handset in 3 should either see base stations from the left 2 or from the right 2, but it must be impossible, that a handset in 3 can see base stations from the left 2 and at the same time from the right 2.

Capacity

Defines the role of the device the DECT manager is located on. The device role has an impact on how many base stations and handsets can be handled by the DECT manager

Small Besides the DECT manager the device acts also as a base station. The DECT manager can handle up to 10 base stations and up to 50 handsets.

Medium There is only the DECT manger running on the device. The DECT manager can handle up to 60 base stations and up to 250 handsets.

- ▶ Select the desired device role for the DECT manager.



If you change the device role from **Small** to **Medium** and the local base station was synchronization level 1, it will be deactivated. Base stations synchronization needs to be adjusted in order to re-synchronize the system.

Reboot

- ▶ From the option menu select the devices you want to reboot: the **DECT Manager** only or the **DECT Manager and base stations**.
- ▶ Click on **Reboot now** ▶ Confirm with **Yes** ... the reboot starts immediately.



All existing connections managed by the affected base stations are terminated.

To reboot one single base station: → p. 47

System log

The system report (SysLog) gathers information about selected processes performed by the DECT manager and base stations during operation and sends this to the configured SysLog server.

Activate system log

- ▶ Mark/unmark the check box to activate/deactivate the logging function.

Server address

- ▶ Enter the IP address or the (fully qualified) DNS name of your Syslog server.
Value: max. 240 characters

Server port

- ▶ Enter the port number, where the Syslog server expects to receive requests.

Range: 1-65535; Default: 514

Transport protocol

- ▶ Select the transport protocol used for communication with the Syslog server.

If you want to use the Integrator's system log server configuration settings for the DECT manager:

- ▶ Click on the **Use Integrator settings** button.



To set up the system log server settings → p. 119.

SNMP statistics

The Simple Network Management Protocol (SNMP) is a common protocol used for monitoring and controlling of network devices. To gather management and statistical information concerning base station events to be processed by an SNMP manager you have to enter the address and authentication information according to the SNMP server configuration.

SNMP manager address

- ▶ Enter the IP address of the SNMP manager server. If the address is 0.0.0.0, the SNMP service is deactivated.

SNMP manager port

- ▶ Enter the port number used by the SNMP manager. Default: 162

To access the SNMP database authentication is necessary.

- ▶ Enter the **SNMP username** and the **SNMP password**.
- ▶ Click on **Activate/Deactivate** to start/stop collecting statistical information for SNMP.

The SNMP manager access data can be set for the individual DECT manager or for all DECT managers via Integrator configuration (→ p. 120).

- ▶ If for the DECT manager the Integrator configuration should be used, click on **Use Integrator settings**.

Storing management information in MIB format

For further processing of the statistic data using a MIB browser (Management Information Base) you can download the data for all base stations of the DECT manager in MIB format (Managed Objects).

- ▶ Click on **Download MIB** ▶ Select the location where the MIB file should be stored using the system file selection dialogue ... the file with the MIB information is stored in TXT format.

Setting time zone

- ▶ Select the time zone for your location from the **Time Zone** option menu.

Blocking calls

You can define a period of time in which all calls are blocked by the DECT manager, e.g. for maintenance activities. If a user initiates a call in this time, a message is shown on the handset.

Service action

- ▶ Currently only **Block new calls** is available. If activated, all incoming and outgoing calls are temporarily blocked. To activate the service, enter a start time and the duration, and click on **Set**.

Start time

- ▶ Enter the date and time when the call block service should be started. Format: YYYY-MM-DD HH:mm.

or

- ▶ Mark the check box **Immediately** to start the service at once.

New calls blocked duration

- ▶ Determine how long (days, hours, minutes and seconds) the DECT manager should block all calls.

Setting up DECT manager redundancy

Only available with a virtual integrator managing multiple DECT managers.

On this page you set up the backup DECT manager as redundancy system for the master DECT manager you have selected on the DECT manager administration page.



The DECT manager redundancy feature only provides redundancy for the DECT manager role, but not for the local base station functions. Therefore on both DECT manager devices the DECT base should be deactivated.

A failover to the backup DECT manager takes place when

- the backup DECT manager recognizes, that significant majority of base stations are disconnected from the master DECT manager,
- the backup DECT manager recognizes, that significant majority of base stations are connectable to backup DECT manager. (Significant means: $\geq 60\% + 1$ of active base stations),
- this situation continuously lasts for more than 7 minutes. This prevents a failover from taking place during the regular software update duration (6 minutes).

The name of the DECT manager for which the backup is set up is shown next to **Backup for**.

- ▶ In the **DM Name** field enter the name of the DECT manager to act as a backup system.
- ▶ Enter a password to access the Integrator.



- ▶ Now configure the backup DECT manager with the integrator settings. To do this, use the web configurator of the backup DECT manager.

DECT manager registration

You can now register the DECT managers at the Integrator.

- ▶ Assign the device role **DECT-Manager+Base - dynamic IP** to the devices that are defined to act as DECT manager.
- ▶ Enter the IP address for a DECT manager device in the address field of the web browser and login.
- ▶ Open the **Settings ▶ System ▶ Integrator Config** page.

On this page you can register the DECT manager at the Integrator.

It is only available in the DECT manager user interface for the user role **admin**.

Integrator IP Address

- ▶ Determine the IP address of the Integrator (e.g. from the VM software or the DHCP server of your network) and enter the IP address in the field.

DM Id

- ▶ Enter the identifier of the DECT manager as defined in the Integrator's DECT manager administration.

Connection password

- ▶ Enter the password that is assigned to the corresponding **DM Id** in the Integrator's DECT manager administration.

Connection status

- ▶ Shows whether the DECT manager is currently connected to the multicell system or not (**Connected / Not connected**).
- ▶ Click on **Set** to save the settings of this page.

If a DECT manager is successfully registered, the corresponding entry in the Integrator's DECT manager list is supplemented by the IP address.

DECT manager synchronisation

This page allows you to configure external synchronisation references for synchronisation clusters of your DECT managers.

It is only available in the Integrator user interface for the user role **admin**.

This way you could configure inter DECT manager synchronisation rules, to get base stations of multiple DECT managers in sync. Cluster-internal synchronisation is defined via base station synchronisation (→ p. 50).

A cluster can synchronise to a cluster-external source, for example:

- The best base station of another cluster within the same multicell system.
Best means the base station with the strongest radio signal.

- An external DECT system referenced by its RFPI.
RFPI is a unique identifier for a DECT system. You can enter a full matching RFPI to reference a specific base station or a part of an RFPI in order to reference a group of base stations.
- The LAN master of a DECT manager.



Further information on RFPI: → wiki.gigaset.com

The page allows you to add, edit and delete the cluster synchronization references.

► **Settings** ► **DECT Manager** ► **Synchronisation**

The table shows the currently defined synchronisation references with the following information:

DM Name

Name of the DECT manager in the multicell system.

Cluster

Cluster number of the DECT manager to which the synchronisation setting applies.

Cluster external sync

Indicates how the cluster is synchronized:

No external sync	Level 1 base of the cluster will only synchronise internally.
Best DECT base of DM	Level 1 base of the cluster will synchronise with the best accessible base station of the DECT manager shown in the Reference column, regardless of the cluster.
Ext RFPI xxx	Level 1 base of the cluster will synchronise with another DECT system referenced by the RFPI shown in the Reference column. Different RFPI matching levels are possible, e.g., Ext RFPI (full match) , Ext RFPI (-1 match) , Ext RFPI (-2 match) , ...
LAN Master of DM	Level 1 base of the cluster will synchronise with the LAN master of the DECT manager shown in the Reference column.

Reference

Reference to the synchronizing external DECT system. In case of **Best DECT base of DM** and **LAN Master of DM** the DECT manager identifier. In case of **Ext RFPI xxx** the RFPI or a part of an RFPI.

Actions

Adding a synchronization reference to the list

- Click on **Add** ... the DECT manager synchronization page is opened.

Deleting a synchronization reference from the list

- Select the check box next to the sync reference you want to delete. Multiple choice is possible. ► Click on **Delete** ► Confirm with **Yes** ... all selected sync references are deleted.

Editing a synchronization reference

- ▶ Click on  next to the DECT manager synchronization you want to edit ... the DECT manager synchronization page is opened.

Adding/Editing a synchronization reference

This page allows you to define which DECT device is responsible to synchronize a cluster managed by the DECT manager. You can edit an existing entry of the DECT manager synchronization table or add a new entry.

DM Name

- ▶ For a new entry: Select a DECT manager from the option menu.

For an existing entry the identifier is shown.

Cluster

- ▶ For a new entry: Select a cluster number of the selected DECT manager. Only one synchronization reference can be set for a cluster.

For an existing entry: The cluster number of the selected DECT manager is shown.

Cluster external sync

- ▶ Select the cluster's synchronisation reference:

No external sync	Level 1 base of the cluster will only synchronise internally.
Best DECT base of DM	Level 1 base of the cluster will synchronise with the best accessible base station of the DECT manager.
Ext RFPI xxx	Level 1 base of the cluster will synchronise with another DECT system. Different RFPI matching levels are possible. The RFPI or a part of an RFPI must be entered in the Reference text field. Matching base stations are used to synchronise.
LAN Master of DM	Level 1 base of the cluster will synchronise with the LAN master of the DECT manager.

Reference

In case of **Best DECT base of DM** and **LAN Master of DM**:

- ▶ From the **Reference** option menu select the DECT manager.

In case of **Ext RFPI xxx**:

- ▶ In the **Reference** field enter the RFPI or the part of the RFPI of the base station(s) to which the cluster can be synchronised.

Base stations

The Integrator automatically recognises the base stations within the network. Base stations need to be confirmed, activated and synchronised.

Base stations administration

The page allows you to assign base stations to the DECT managers.

It is only available in the Integrator user interface for the user role **admin**.



► **Settings** ► **Base stations** ► **Administration**

There are two tables:

- **Connected base stations** lists all base stations which are already connected to the DECT manager.
- **Pending base stations** lists all base stations which are not yet connected to a DECT manager.

Connected base stations

The page shows the connected base stations with the following information:

MAC address	Hardware address of the base station. With this address the device is uniquely identified within the LAN.
Base station	Name of the base station. When added to the list the MAC address is used as name. The base station located at the same device as the DECT manager is shown as LocalBS . The name can be edited. The symbol  indicates that the base station function is disrupted.
RPN	(Radio Fixed Part Number) Part of the RFPI. Identifies the base station on the air interface. It also enumerates the base station within a DECT manager. Each DECT manager gets a group of RPN to assign to its base stations. So it is possible to identify the DECT manager the base station belongs to.
DM Name	Name of DECT manager the base station belongs to. The symbol  indicates that the DECT manager is currently disconnected.
FW	Version of the currently installed firmware. The turning symbol  indicates that currently a firmware update is in progress.

Status	Synchronization status of the base station:	
	Offline	Not available
	Deactivated	Available but not activated
	No sync	Activated but not synchronised
	Sync	Activated and synchronised,
	Sync overload	Synchronised, but DECT overload; attempts were made at this base station to initiate more than the permitted simultaneous calls.

Actions

Editing base station data

- ▶ Click on  next to the base station you want to edit ... the data page for the base station is opened.

Displaying detailed statistical data on the base stations

- ▶ Click on the  button next to the name of a base station ... statistical evaluations about the base station synchronisation as well as further system information are output.

Deleting base station

- ▶ Select the check box of one or more base stations ▶ Click on **Delete** ▶ Confirm with **Yes** ... All selected base stations are deleted. They are shown in the list of pending base stations again.

Exporting/Importing the base station configuration

You can export the base station configuration and import it into another DECT manager, in order to change the DECT manager assignment.

Exporting:

- ▶ Select all base stations you want to be transferred via the check mark next to the MAC address.
- ▶ Click on **Export** ▶ Select the location where the export file should be stored using the system file selection dialogue.

Preferably, you want to export and import base stations DECT manager by DECT manager:

- ▶ Filter the base station list by **DM Name**. So you can easily export base stations of this specific DECT manager.

Importing:

- ▶ Click on **Import** ▶ Select the previously exported base station configuration file from your computer's file system.
- ▶ Select the DECT manager into which base station export should be imported from the **DM Name** list and the **IP address type** from the corresponding list. ▶ Click on **Import**.



The export contains all data. The import does not contain the data of the local base station, because the local base station is physically bound to the (potential) new DECT manager.

Please review your sync settings after a base station import.

Enabling/Disabling LED status display at the base station

LED displays are enabled by default on all base stations.

- ▶ Select **Yes/No** to enable/disable the LED display on all base stations.

Pending base stations

The **Pending base stations** list shows the automatically recognised DECT base stations in the network that have not yet been registered. If a base station is detected by several DECT managers, there are several entries for one base station. To integrate them into your DECT network, they need to be confirmed and activated.

The base stations are identified by their MAC address.

You can filter the list of pending base stations by specific DECT managers to get the list shorter and to add the base stations DECT manager by DECT manager.

Assigning a base stations to your DECT manager

- ▶ Click on in the row of the base station you want to add to your system ... the data page for the base station is opened.



The relation to a DECT manager cannot be edited and changed. To assign a base station to another DECT manager:

- ▶ Delete it from the **Connected base stations** list ... The base station is displayed again in the **Pending base stations** list, with one entry for each DECT manager that is detecting it on the DECT network.
- ▶ Select the base station entry of the desired DECT manager and add it to the system.

Adding/Editing base stations

On this page you enter the data for a base station to be added to the DECT manager or edit the data for a base station that is already assigned to the DECT manager.

It is only available in the Integrator user interface for the user role **admin**.

The following information is displayed and cannot be changed:

MAC address

Hardware address of the base station. With this address the device can be uniquely identified within the Ethernet. It cannot be changed

DM Name

Name of DECT manager the base station belongs to. **local**: The base station belongs to the configuring device.

Status

Synchronization status of the base station:

Offline	Not available
Deactivated	Available, but not activated
No sync	Activated, but not synchronised
Sync	Activated and synchronised
Sync overload	Synchronised, but DECT overload; attempts were made at this base station to initiate more than the permitted simultaneous calls.

IP address

Current IP address of the Base station.

RFPI = PARI + RPN (hex)

(RFPI = Radio Fixed Part Identity) unique name of the base station in a multicell DECT network. It consists of:

- PARI (Primary Access Rights Identity): unique system ID of a base station
- RPN (Radio Fixed Part Number): base station number within the DECT network
The two most significant bits in the RPN represent the RPN group of the DECT manager.

Current firmware version

Firmware version currently installed.

Sync Level

Base station synchronisation level.

The following data can be edited**Name / Location**

This name should make it easier to assign the base station within the logical and spatial structure of the DECT network.

- ▶ In the text field enter a descriptive name or description for the base station.
Value: max. 32 characters

IP address type

The IP address type is copied from the setting for the DECT manager on the **Network – IP/LAN** page (→ p. 33). You can change the IP address type. The settings for the DECT manager and the base stations do not have to match. For example, the DECT manager could receive a fixed IP address so that it will always be able to access the web configurator with the same address, while the base stations receive their IP addresses dynamically.

- ▶ Select the desired IP address type from the option menu.

If the IP address type is **Static**, you have to enter the IP address.

IP address

- ▶ Enter an IP address for the base station.

Reduce transmitting power for external antenna operation

Only relevant if the unit has external antennas.

The transmitting power of the external antennas can be reduced. This may be necessary in order not to violate country-specific emission regulations if the unit is equipped with external antennas and an external patch antenna (with a gain of 8dB) is used instead of the normal external sleeve antenna (with a gain of 3dB).

- ▶ Click on **Yes/No** to reduce/not reduce the transmitting power.

Act as Sync Master redundancy

Only relevant in multi-cell systems.

If the DECT sync master or the LAN sync master fails, the base station can take over its role.

- ▶ Click on **Yes/No** to define the base station to act/not to act as redundancy sync master.

If you select **Yes**, the **Sync Level** is automatically set to 2→1 to indicate that level 2 is able to become level 1.



The base station must be seen by all level 2 base stations with good quality to assure that the network can still be synchronised in case of a take-over.

Activating/deactivating the base station

A base station must be active to manage the calls of the connected handsets. If it is deactivated, it will no longer connect handsets but it still stays in the list of connected base stations.

- ▶ Select **Yes/No** to activate/deactivate the base station.



Please ensure that the base station you want to deactivate is not on sync level 1. Check your sync settings before deactivating a base station. Otherwise your system may no longer work properly.

Adding a base station to the Connected Base Stations list

- ▶ Click on **Confirm**

Delete the base station

- ▶ Click on **Delete base station** ▶ Confirm with **Yes** ... the base station is deleted. It is shown in the list of pending base stations again.

Reboot the base station

- ▶ Click on **Reboot base station** ▶ Confirm with **Yes** ... the base station is rebooted. All existing connections managed by the base station are terminated.

Base station synchronisation

Synchronisation and the logical structuring of the base stations in clusters are prerequisites for the functioning of the multicell system, inter-cell handover, and (over)load balancing. Overload balancing means that a handset can roam to a free base, when current base is fully loaded and cannot accept further handset connections.

Base stations can be synchronised "over the air", meaning that they are synchronised via DECT. If the DECT connection between specific base stations seems to be not reliable enough, synchronisation can also take place via LAN. To carry out the synchronisation you will need the plan of the clusters with the synchronisation level for each base station.



Synchronisation always refers to a cluster. In case you set up several clusters that are not synchronised with one another, there will be no possibility of a handover or (over)load balancing between them.

Synchronisation for handover between base stations in clusters managed by different DECT managers can be configured via DECT manager administration (→ p. 50).

For detailed information on DECT network planning, please refer to the "DECT Site Planning Kit (SPK) PRO" Guide.



A base station shows its synchronisation status with an LED (→ p. 24).

Synchronisation planning

Base stations that combine to form a DECT wireless network must synchronise with one another to ensure a smooth transition of the handsets from cell to cell (handover). No handover and no (overload) balancing is possible between cells that are not synchronised. In the event of loss of synchronisation, the base station stops accepting calls once all ongoing calls that were being conducted on the asynchronous base station have ended and then it re-synchronises the asynchronous base station.

The synchronisation within a cluster takes place in a master/slave procedure. This means that one base station (sync master) defines the synchronisation cycle for one or more additional base stations (sync slaves).

The synchronisation needs some kind of synchronisation hierarchy with the following criteria:

- 1 There must be one single and common root source for the synchronisation in the hierarchy (sync level 1).
- 2 With synchronisation over LAN there are just two levels needed (LAN-Master and LAN-Slave).
- 3 DECT synchronisation usually needs more than two levels and just one hop, because most base stations won't be able to receive the DECT signal from the root source of the synchronisation (sync level 1). DECT signal providing reference timer synchronisation is relayed along a chain of multiple base stations, until it finally synchronises the last base station in a sync chain.

- The number of hops along any branch of DECT synchronisation tree should be minimised, because any hop can introduce jitter in the synchronisation timer and could so lower the quality of the synchronisation.

DECT-based synchronisation

To relay DECT synchronisation signals from base station A to base station B, base station B must be able to receive signals from base station A with sufficient signal quality.



DECT manager and base stations must be connected to the same Ethernet or virtual LAN sharing a common broadcast domain.

A base station can synchronise with each base station on a higher sync level. The sync level concept allows base stations to automatically select the best suitable base station (having a lower sync level number) to receive synchronisation signal from. Simultaneously, it guarantees a strictly limited number of hops along any branch in the synchronisation tree and to prevent circles between automatically optimised synchronisation chains.

During configuration, assign one level in the synchronisation hierarchy (sync level) to each base station. Sync level 1 is the highest level; this is the level of the sync master and appears only once in each cluster. A base station always synchronises itself with a base station that has a better sync level. If it sees several base stations with a better sync level, it synchronises itself with the base station that provides the best signal quality. If it does not see any base station with a higher sync level, it cannot synchronise.

LAN-based synchronisation along the synchronisation path

If the DECT connection between base stations seems to be not reliable enough to permanently guarantee a stable DECT over the air synchronization, e.g., because they are separated by iron doors or a firewall, you can determine that synchronisation should take place via LAN. In this case the base station with the higher sync level will act as LAN master, the base station with the lower sync level is a LAN slave. One base station must be explicitly be defined as LAN master. This should not be the device on which the DECT Manager is also located.

Advantages of LAN synchronisation compared with DECT synchronisation:

- Higher flexibility in the arrangement of the base stations as no synchronisation chains need to be formed.
- Fewer base stations required as the overlapping area of the base stations is smaller. The overlapping area for handset handover can be smaller, because neighbored base stations do not need to receive each other in stable error free quality, but they must still be able to detect each other for the process of dynamic channel selection.
- Configuration of the system is simplified as all base stations can be synchronised on one synchronisation master.

Network requirements

- The N870 IP PRO devices must be connected to a switch port of minimum 100 Mbit/s with corresponding cabling.
- PoE IEEE 802.3af < 3.8 W (Class 1) for an alternatively external power supply.
- The DECT manager and all its base stations must be in the same layer 2 segment (common broadcast domain).

Requirements for LAN synchronisation

- Minimum number of switch hops between master and all slave base stations.
- For internally and uplink switching use Enterprise class switches ≥ 1 Gbit/s.
- VLAN based QoS could be fruitful to minimise packet delay and its jitter. Switch port based VLAN can isolate base stations from other devices' traffic.
- DSCP (Differentiated Services Codepoint) based QoS could be even more efficient.

Settings for DSCP tagging:

Sync via LAN:	PTPv2, DLS (proprietary): DSCP=CS7=56	
RTP:	DSCP=EF=46	
SIP:	DSCP=AF41=34	

- Synchronisation via LAN makes intensive use of IP multicasts which have to be supported by the switches.

Multicast destination address and ports:

PTPv2:	224.0.1.129	UDP via ports 319/320
Proprietary DLS protocol:	239.0.0.37	UDP via ports 21045/21046

Cascaded switches might need uplink switching of these multicast packets to allow inter-switch LAN synchronisation. Otherwise you need isolated LAN-sync clusters, inter-cluster-synchronized via DECT.

- IGMP snooping is supported and shall be supported by the switch, to configure and minimise multicast distribution only to the LAN synchronising base stations.

Packet delay jitter

Minimum packet delay jitter between LAN master and LAN slaves is crucial for successful synchronisation over LAN.

- LAN master role should be assigned to that switch port, that offers the lowest packet jitter to all LAN-Slaves.
- If there are several suitable devices, the LAN master role should be assigned to a device that has little traffic.

This is preferably a base station with low VoIP traffic. If in doubt, you can even deactivate DECT at the base station and operate the base station only as LAN master. As a rule, however, this is not necessary.

Devices that include the DECT manager (and the integrator) in addition to the base station are not recommended as LAN masters due to the variety of tasks and traffic to be served. This applies to devices with medium capacity if DECT is deactivated for the base station. The performance advantage thus gained is easily consumed by the DECT manager and integrator functions.

As multiple LAN traffic parameters could have an impact on packet delay and its jitter, specific switches and maximum number of switch hops are required, to guarantee sufficient maximum packet delay jitter.

Consider the following:

- The less switch hops, the lower the transmission delay and its jitter will be.
- The higher the bandwidth or quality of used switches is regarding packet delay and its jitter, the lower the packet delay and the lower the packet delay jitter will be.

- Enhanced packet processing logics (like L3 switching or packet inspection) could have significant negative impact on the resulting packet delay jitter. If possible, they should be deactivated for N870 IP PRO base stations connected switch ports.
- Significantly increased traffic load on a switch, in the range of the maximum throughput, could have significant negative impact on the packet delay jitter.
- VLAN based prioritisation of LAN packets could be a fruitful measure to minimize packet delay and its jitter for N870 IP PRO base stations.

Acceptable Network Jitter for LAN-synchronisation

LAN synchronisation is based on a two layer design:

- Native PTPv2 is used to synchronise a common reference timer along all base stations involved.

Target quality benchmark to provide sufficient PTP synchronisation along the base stations, is to have a **PTP deviation lower than 500 ns** (rms). For this PTP synchronisation a few single deviations > 500 ns are accepted and might just generate first warnings. If the PTP sync packet deviation does continuously exceed this limit of 500 ns, the PTP synchronisation is considered broken and will lead to new start synchronisation procedure.

- Based on the PTP synchronisation LAN master and LAN slave adjust their DECT reference timer to one common offset to the common PTP reference timer. This common offset will be permanently monitored by a proprietary communication.

The target quality benchmark for this synchronisation level is to see reference timer deviation by this DECT reference timer sync packets: **DECT-LAN-Sync deviation lower than 1000 ns**. A good mean value would be 500 ns (rms).

To meet this criteria the switches themselves do not necessarily need to be PTP aware. But the network should consider the above mentioned guidelines to meet this criteria.



Further information on PTP is available from wiki.gigaset.com.

Cluster selective LAN synchronisation

LAN synchronisation consists of two layers:

- Standard PTP which is shared within a multicast IP domain between all DECT managers
- Proprietary DLS (DECT over LAN Sync) which synchronises the clusters isolated within one DECT manager

Multiple DLS domains are possible per DECT manager as DECT manager clusters. A cluster forming an isolated PTP domain needs to have one LAN master of its own. Maximum one LAN master is allowed per cluster.

DLS sync master and slave do care for matching DECT manager and cluster numbers.

Cluster numbers

For LAN synchronisation a cluster needs to be assigned to a PTP domain. This assignment takes place via the cluster number.

Cluster numbers from 1-c to 7-c (c = common)	Build up one common PTP sync domain
Clusters numbers 8-i to 15-i (i = isolated)	Build up an isolated PTP sync domain per each such cluster number

- Inter-DM-LAN sync is only possible with matching cluster number (independent from the PTP domain).
- DECT managers forming one common LAN synchronisation domain need to use a cluster number from common domain (1..7) or an identical cluster number of isolated domain (8..15).
- DECT managers using different PTP domains (cluster numbers 8..15) cannot be synchronised by inter-DECT manager LAN synchronisation rule (Reference=**LAN Master of DM x**), but only by inter-DM DECT synchronisation rule.

The mentioned PTP domain in aspect of cluster numbers is only relevant for LAN master and LAN slave base stations. For DECT synchronisation, cluster numbers do not have any additional relevance beside just identifying different clusters.

Example scenarios for small/medium systems (single DECT manager clusters)

Synchronisation for handovers between base stations in clusters managed by one DECT manager are configured via the base station administration using the web configurator. Below are some example scenarios.

Scenario 1: Pure DECT

- Your environment ensures a stable DECT over the air synchronisation
- Cluster 1-c is created to insure handover, roaming and load balancing
- The base station in the centre is DECT level 1 to reduce the amount of sync levels
- Environment blocks DECT signal (e.g., a passage through a fire door)
- Second cluster 2-c is created to cover the area that can't be reached by cluster 1-c
- No handover (active calls are disconnected when switch over between clusters)
- Roaming between clusters is possible (handsets in idle mode can switch between clusters)

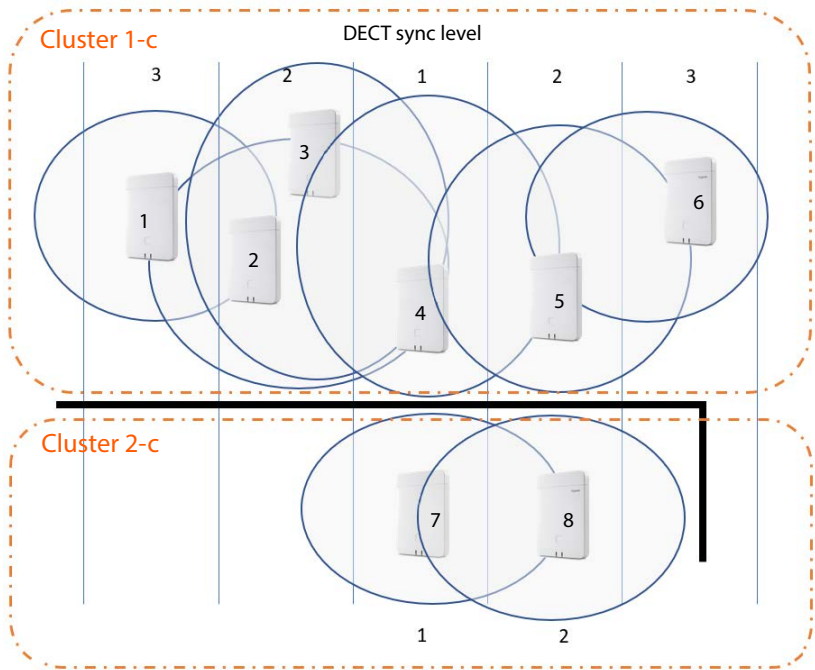
**Configuration:**

Base station	Cluster	Sync Level	LAN Master	Sync Slave
1	1-c	3		DECT
2	1-c	2		DECT
3	1-c	2		DECT
4	1-c	1		DECT
5	1-c	2		
6	1-c	3		DECT
7	2-c	1		DECT
8	2-c	2		DECT

Scenario 2: Pure LAN

- Use such a configuration, if all requirements for LAN synchronisation are fulfilled
- Cluster 1-c is created to insure handover, roaming and load balancing
- Base 4 is configured as LAN master
- DECT level has no relevance for pure LAN synchronisation
- Handover and roaming is possible within the whole DECT environment
- That LAN sync is used, does not mean that DECT signal range is not important

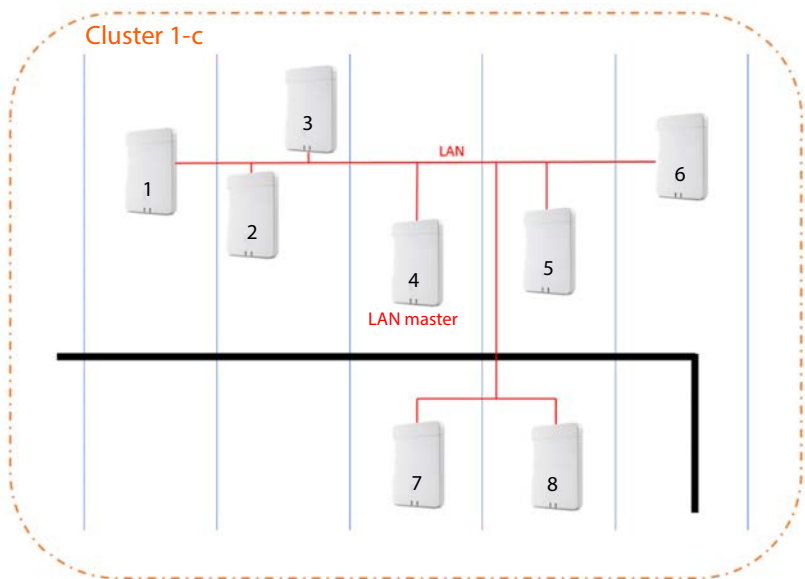

Configuration:

Base station	Cluster	Sync Level	LAN Master	Sync Slave
1	1-c	2		LAN
2	1-c	2		LAN
3	1-c	2		LAN
4	1-c	1	<input checked="" type="checkbox"/>	
5	1-c	2		LAN
6	1-c	2		LAN
7	1-c	2		LAN
8	1-c	2		LAN

Scenario 3: DECT-LAN mixed

- Use such a configuration, if your environment is mainly able to synchronise via DECT but there are particular circumstances which cannot always guarantee reliable DECT synchronisation, e.g., a passage through a fire door
- Cluster 1-c is created to insure handover, roaming and load balancing
- Base station 1 in the centre is DECT level 1 to reduce the amount of sync levels
- Base 1 with DECT level 1 is configured as LAN master
- For each base lower than the LAN master you can individually decide whether it should be synchronised via DECT or LAN
- Base 7 is synchronised via LAN and has DECT sync level 4
- Base 8 is synchronised via DECT and will synchronise with Base 7 via DECT, therefore the DECT sync level 5

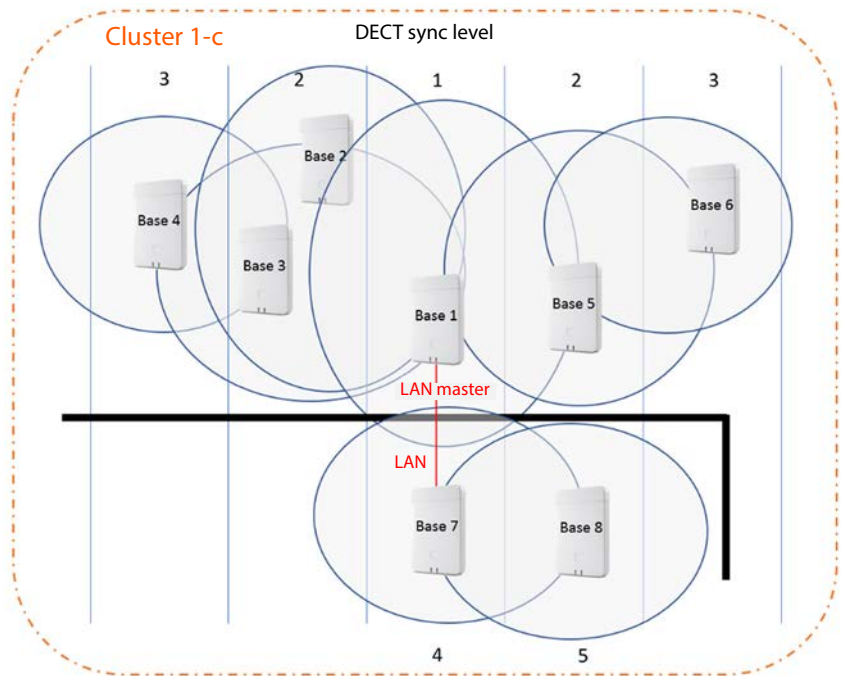

Configuration:

Base station	Cluster	Sync Level	LAN Master	Sync Slave
1	1-c	1	<input checked="" type="checkbox"/>	
2	1-c	2		DECT
3	1-c	2		DECT
4	1-c	3		DECT
5	1-c	2		DECT
6	1-c	3		DECT
7	1-c	4		LAN
8	1-c	5		DECT

Example scenarios for large systems (multiple DECT manager clusters)

Synchronisation for handovers between base stations in clusters managed by different DECT managers are configured via the DECT manager administration using the web configurator. Below are some examples based on two DECT managers. Detailed information on configuration can be found in the N870 IP PRO - Installation, configuration and operation.

Scenario 1: DECT – DECT – DECT

- Integrator (virtual or embedded)
- Two devices with role of DECT manager only
- Every DECT manager has two DECT base stations
- Cluster 1-c on the left side uses DECT synchronisation
- Cluster 1-c on the right side uses DECT synchronisation too (even if the name is the same, it is a different cluster as it is part of another DECT manager)
- Between the clusters also DECT synchronisation is used

Advantage:

- Users can move within the system with handover and roaming.
- DECT synchronisation, no network requirements for LAN sync.

Attention:

- Enough DECT signal quality should be available within the complete system, also between the clusters.
- Every DECT manager must have a different RPN group.

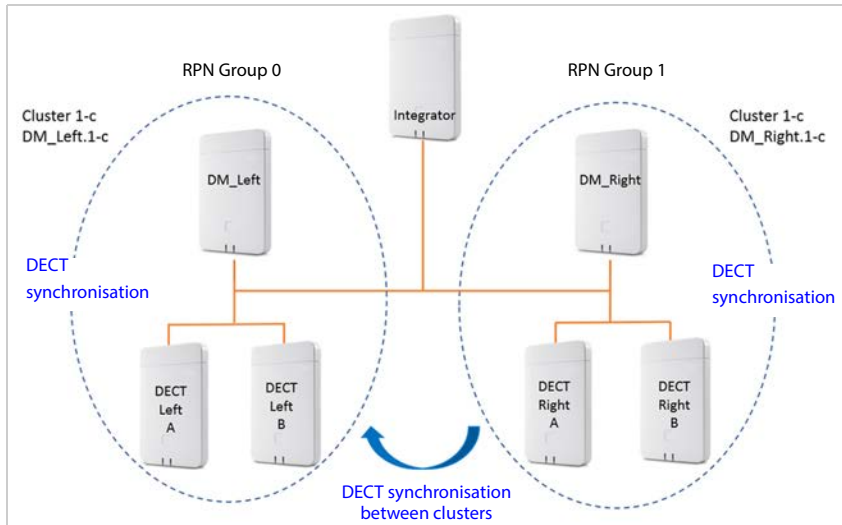

Configuration:

Base station	DM Name	Cluster	Sync Level	LAN Master	Sync Slave
DECT_Left_A	DM_Left	1-c	1		
DECT_Left_B	DM_Left	1-c	2		DECT
DECT_Right_A	DM_Right	1-c	1		
DECT_Right_B	DM_Right	1-c	2		DECT

Scenario 2: DECT – DECT – LAN

- Integrator (virtual or embedded)
- Two devices with role of DECT manager only
- Every DECT manager has two DECT base stations
- Cluster 1-c on the left side uses DECT synchronisation
- Cluster 1-c on the right side uses DECT synchronisation too (even if the name is the same, it is a different cluster as it is part of another DECT manager)
- Between the clusters LAN synchronisation is used
- Base station **DECT_Left_A** is the PTP source (LAN master)

Advantage:

- Users can move within the system with handover and roaming.
- Synchronisation between the two clusters was not possible due to DECT signal range was not enough. LAN sync is the solution.

Attention:

- The customer network between the clusters must be capable to be used for LAN synchronisation. This needs more configuration in the customer network than using DECT synchronisation.

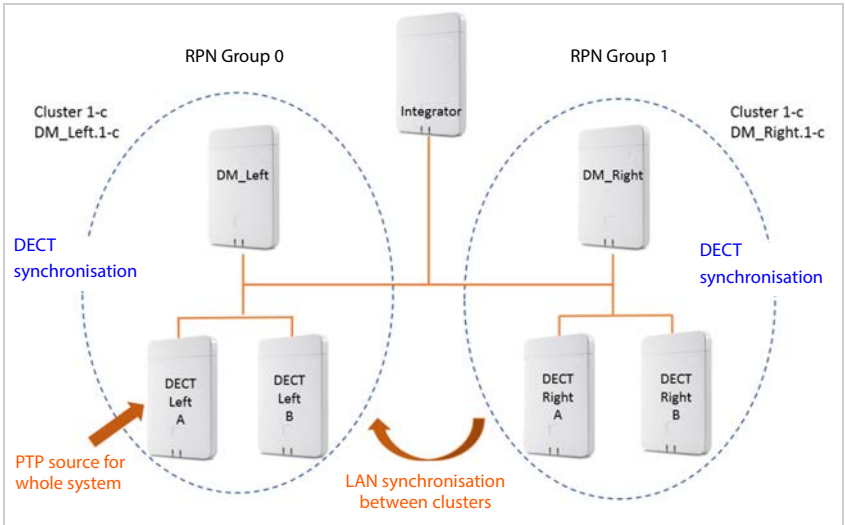

Configuration:

Base station	DM Name	Cluster	Sync Level	LAN Master	Sync Slave
DECT_Left_A	DM_Left	1-c	1	<input checked="" type="checkbox"/>	
DECT_Left_B	DM_Left	1-c	2		DECT
DECT_Right_A	DM_Right	1-c	1		
DECT_Right_B	DM_Right	1-c	2		DECT

Scenario 3: LAN – LAN with isolated PTP domain – DECT

- Integrator (virtual or embedded)
- Two devices with role of DECT manager only
- Every DECT manager has two DECT base stations
- Cluster 1-c on the left side uses LAN synchronisation
- Cluster 8-i on the right side uses LAN synchronisation (cluster 8-i is the first isolated cluster)
- Between the clusters DECT synchronisation is used
- DECT base **Left A** is the PTP source for cluster 1-c
- DECT base **Right A** is the PTP source for cluster 8-i

Advantage:

- Users can move within the system with handover and roaming.

Attention:

- The customer network must be capable to be used for LAN synchronisation. This needs more configuration in the customer network than using DECT synchronisation.
- Every DECT manager must have a different RPN group.

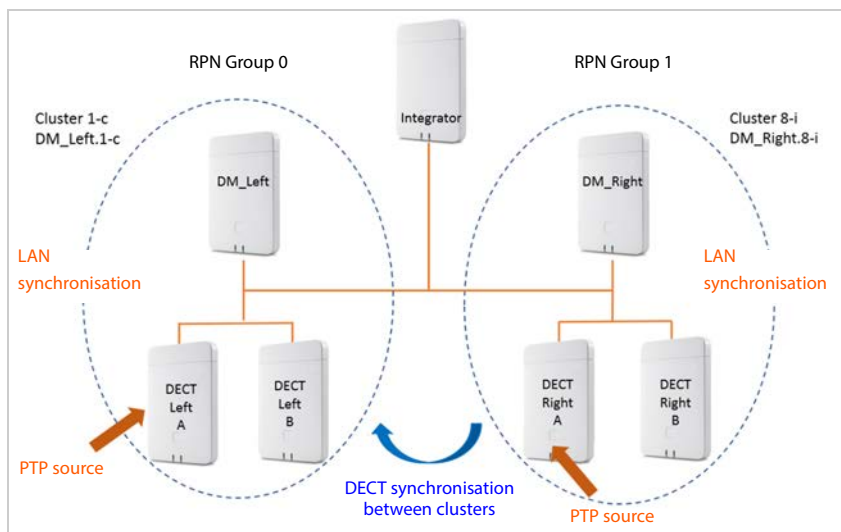

Configuration:

Base station	DM Name	Cluster	Sync Level	LAN Master	Sync Slave
DECT_Left_A	DM_Left	1-c	1	<input checked="" type="checkbox"/>	
DECT_Left_B	DM_Left	1-c	2		LAN
DECT_Right_A	DM_Right	1-c	1	<input checked="" type="checkbox"/>	
DECT_Right_B	DM_Right	1-c	2		LAN



Further examples are available from wiki.gigaset.com.

List of synchronised base stations

All activated base stations contained in the **Connected base stations** list appear in the **Base station synchronisation** list.

It is only available in the Integrator user interface for the user role **admin**.

► Settings ► Base stations ► Synchronisation

For each registered base station the following information is shown:

MAC address	Hardware address of the base station. With this address the device is uniquely identified within the LAN.										
Base station	Name of the base station.										
DM Name	Name of DECT manager the base station belongs to.										
Cluster	Number of the cluster to which the base is assigned.										
Sync Level	Synchronisation level within the sync hierarchy. A base station that is defined as redundancy sync master is automatically set to sync level 2→1 to indicate that level 2 is able to become level 1.										
LAN Master	The base station acting as LAN master is marked by a <input checked="" type="checkbox"/> .										
Sync Slave	Indicates if the base station is synchronised via DECT or via LAN. For the Sync master there is no entry in this column.										
Status	Synchronization status of the base station: <table> <tbody> <tr> <td>Offline</td> <td>Not available</td> </tr> <tr> <td>Deactivated</td> <td>Available but not activated</td> </tr> <tr> <td>No sync</td> <td>Activated but not synchronised</td> </tr> <tr> <td>Sync</td> <td>Activated and synchronised,</td> </tr> <tr> <td>Sync overload</td> <td>Synchronised but DECT overload</td> </tr> </tbody> </table>	Offline	Not available	Deactivated	Available but not activated	No sync	Activated but not synchronised	Sync	Activated and synchronised,	Sync overload	Synchronised but DECT overload
Offline	Not available										
Deactivated	Available but not activated										
No sync	Activated but not synchronised										
Sync	Activated and synchronised,										
Sync overload	Synchronised but DECT overload										

Reference	Sync reference:	Sync type, DECT manager or RFPI, cluster
	Sync type:	
	1	no Sync Slave function, running free
	D	DECT slave within cluster: name of cluster in Reference column
	D →	DECT slave running inter DM synchronisation rule Best DECT base of DM : name of DM in Reference column
	L	LAN slave within cluster: name of internal DM in Reference column
	L →	LAN slave running external/inter DM synchronisation rule LAN Master of DM xy : name of external DM in Reference column
	R →	DECT slave running external RFPI synchronisation rule: RFPI in Reference column

Cluster configuration

The page allows you to synchronise the system manually.

- ▶ Select the DECT manager you want to synchronise from the **DM Name** option menu ... the cluster configuration of the selected DECT manager is displayed below

Synchronising all clusters of the DECT manager

- ▶ Click on **Synchronise all**

Synchronising a specific cluster of the DECT manager

- ▶ From the **Sync Slave** option menu select which kind of synchronisation you want to perform (**LAN** or **DECT**) ▶ Click on **Synchronise**

Actions

Setting up the base station synchronisation

- ▶ Select the cluster to which the base should be assigned to from the **Cluster** option menu. Base stations only synchronise within the same cluster, meaning that a handover of a handset from one cluster to a neighbouring cluster is not possible. The DECT multicell system can manage up to nine clusters.
- ▶ Select the synchronisation level for the base station from the **DECT Level** option menu. DECT level 1 is the highest level and may appear only once in each cluster. A base station always synchronises itself with a base station that has a better sync level. If it sees several base stations with a better sync level, it synchronises itself with the base station that has the strongest signal. If it does not see any base station with a higher sync level, it cannot synchronise.

- ▶ Mark the **LAN Master** check box, if the base station should act as LAN master.
If synchronisation via LAN is used, there must be one base station acting as LAN master. Currently the LAN master can only be configured on DECT level 1.
This device should only be used as a base station. Devices on which the DECT Manager/Integrator is active in addition to the base station are not suitable as LAN masters due to the variety of tasks and traffic to be served.
- ▶ From the **Sync Slave** option menu select whether the base station is to be synchronised via DECT or via LAN. For the Sync master leave this column empty.

Provider and PBX profiles

You can use up to 20 different VoIP PBX or VoIP provider profiles, e.g.

- your company's VoIP PBX
- and/or public providers from which you have requested VoIP services.

This page allows you to create a list of systems providing VoIP connections and other services for your phones.

This page shows all available VoIP connections.

It is only available in the Integrator user interface for the user role **admin**.

▶ Settings ▶ Provider or PBX profiles

Name The name that you have defined for the connection is displayed, or the default name (IP1 - IP20). It can be edited.

Domain Domain part of the user address. In the case that a connection is not used **Not configured** is displayed.

- ▶ Use the **Previous/Next** button to change between VoIP connection 1 to 10 and 11 to 20.

Configuring provider and/or PBX profiles

- ▶ Click on  next to the name of the VoIP connection you want to edit ... the provider/PBX configuration page is opened.

Configuring provider or PBX profiles

On this page you can edit the data for the selected provider or PBX telephony server profile.

It is only available in the Integrator user interface for the user role **admin**.

Connection name or number

- ▶ Enter a name for the provider or PBX profile. This name is shown in the Provider/PBX list. To distinguish between different connections it should specify the respective VoIP service provider.

Phone system

- ▶ Select the type of PBX you use for VoIP provisioning from the option menu.

General provider data

Domain

- ▶ Enter the domain IP address or FQDN (Fully Qualified Domain Name).

Mandatory field for SIP registration. It is used to form the host part of the URI (AoR) together with the assigned user names of the handsets.

Example: URI: <sip/sips>:<hsUsername>@<domain>

Proxy server address

It provides the proxy host, i.e. the network gateway for SIP traffic as a first preference.

- ▶ Enter the IP address or the FQDN (Fully Qualified Domain Name) of your SIP proxy server (max. 74 characters, 0 - 9, a - z, A - Z, -, ,, _).

Examples: **10.100.0.45** or **sip.domain.net** or **sipproxy01.domain.net**

Proxy server port

- ▶ Enter the port number of the first SIP server, where the device should send SIP requests and expects to receive requests.

Range: 1-65535; Default: **5060** (for UDP/TCP), **5061** (for TLS)

DNS SRV SIP server redundancy lookup might provide a different server port which is used then.

Registration refresh time

- ▶ Enter the time intervals (in seconds) at which the phone should repeat the registration with the VoIP server (SIP proxy). A request will be sent to establish a session. The repeat is required so that the phone's entry in the tables of the SIP proxy is retained and the phone can therefore be reached. The repeat will be carried out for all enabled VoIP connections.

Values: 1 - 5 digits, > 0; Default: **600** seconds

Transport protocol

- ▶ Select between UDP, TCP and TLS.

UDP (User Datagram Protocol) UDP is a non session-based protocol. UDP does not establish a fixed connection. The data packets ("datagrams") are sent as a broadcast. The recipient is solely responsible for making sure the data is received. The sender is not notified about whether it is received or not.

TCP (Transmission Control Protocol) TCP is a session-based transmission protocol. It sets up, monitors and terminates a connection between sender and recipient for transporting data.

TLS (Transport Layer Security) TLS is a protocol for encrypting data transmissions on the Internet. TLS is a superordinate transport protocol.

Use SIP Security (SIPS)

Only if TLS is selected. SIPS enhances SIP with TLS/SSL encryption. Using SIPS makes it more difficult to listen in on the connection. Data is transmitted encrypted over the internet.

- ▶ Mark/unmark the check box to enable/disable the use of SIPS.

SRTP options

SRTP (Secure Realtime Protocol) is a security profile to ensure confidentiality, integrity, replay protection and message authentication for audio-visual data transmission over IP-based networks.

- ▶ Select which calls should be accepted:

Secure Real Time Protocol Security is activated for voice connections.

Accept non-SRTP calls Insecure calls are accepted even when SRTP is activated.

Deregister detached HS

The SIP account of handsets that are not reachable can be de-registered automatically.

- ▶ Click on **Yes/No** to enable/disable automatic de-registration.

Redundancy settings

Redundancy - DNS query

Defines the type of a DNS query. A DNS query is triggered if the **Domain** field contains an FQDN.

A	Query for IPv4 records based on the FQDN.
SRV + A	Query for SRV records based on the FQDN, transport protocol and SIP/SIPS scheme flag. SRV list provides list of A records with associated ports. Effectively, the provider obtains a redundancy list of host ports.
NAPTR (NAPTR + SRV + A)	Query for NAPTR records based on the FQDN. NAPTR returns a list of SRV records with the associated transport protocol and SIP/SIPS scheme. Choose only one SRV record with best priority. Query for SRV records. Effectively, the provider obtains a redundancy list of host ports.

Failover server

If **Redundancy - DNS query** = A

In case your provider supports a failover server you can enter the data here.

- ▶ Enable/disable the use of a failover server via the radio boxes next to **Enable registration**.

Registration server

- ▶ Enter the IP address or the (fully qualified) DNS name of the failover registration server.

SIP server port

- ▶ Enter the communication port used on the failover registrar.

Range: 1-65535; Default: **5060** (for UDP/TCP), **5061** (for TLS)

Network data of the service provider

Outbound proxy mode

The N870 IP PRO allows you to configure an outbound proxy. Despite any other SIP protocol rules, if activated (**Always**), the system will always send all outgoing requests towards this outbound proxy. It can be an outbound proxy in the local network provided by the local network provider or in the public network provided by the network/VoIP provider.

- ▶ Specify when the outbound proxy should be used.

Always: All signalling and voice data sent by the system is sent to the outbound proxy.

Never: The outbound proxy is not used.

If the further outbound proxy configuration is identical to the proxy and registrar configuration it is useless and will be ignored.



The DHCP option 120 "sip server" sent by a SIP phone would internally overrule the outbound proxy address and port setting. **Outbound proxy mode** is still and exclusively in the hands of the local device administrator. By setting **Outbound proxy mode** to **Never**, you can prevent any usage of DHCP option 120 by the DECT VoIP phone. To allow for DHCP option 120, you should set **Outbound proxy mode** to **Always**.

Outbound server address

This is the address, where the device should send all SIP requests to and where (in case of successful registration) it expects to receive requests from.

- ▶ Enter the (fully qualified) DNS name or the IP address of your provider's outbound proxy.

Example: **10.100.0.45** or **sip.domain.net** or **sipproxy01.domain.net**

If the **Outbound server address** field is empty, the system behaves independently of the selected mode, as with **Outbound proxy mode** = **Never**.

Outbound proxy port

This is the port number of the outbound proxy server, where the device should send all SIP requests to (and where it in case of successful registration expects to receive requests from).

- ▶ Enter the communication port used by the outbound proxy.

Range: 1-65535; Default: **5060** (for UDP/TCP), **5061** (for TLS)

Outbound proxy port is empty and **Outbound server address** is a name:

The RFC3263 rules will be used to locate SIP servers and select them for load balancing and redundancy.

Outbound proxy port is a fixed number:

The usage of DNS SRV records according to RFC3263 is blocked.

SIP SUBSCRIBE for Net-AM MWI

If activated a subscription is established for the purpose of receiving notifications about new messages on the network mailbox.

- ▶ Enable/disable SIP subscription via the radio boxes next to **SIP SUBSCRIBE for Net-AM MWI**.

DTMF over VoIP Connections

DTMF signalling (Dual Tone Multi Frequency) is required, for example, for querying and controlling certain network mailboxes via digit codes, for controlling of automatic directory enquiries or for remote operation of the local answering machine.

To send DTMF signals via VoIP, you must define how key codes should be converted into and sent as DTMF signals: as audible information via the speech channel or as a "SIP Info" message.

Ask your VoIP provider which type of DTMF transmission it supports.

Automatic negotiation of DTMF transmission

- ▶ For each call, the phone attempts to set the appropriate DTMF signalling type for the codec currently being negotiated: select **Yes**.

The system will use the transmission method matching best the received capabilities from the peer based on the following priority order:

- send via RFC2833, if the PT (Payload Type) for the telephone event is provided by the peer
 - send via SIP INFO application/dtmf-relay, if SIP INFO method is supported by the peer
 - send in-band audio
- ▶ No automatic attempts to set DTMF transmission type: select **No** (DTMF transmission type is **Audio** by default).

Send settings of DTMF transmission

- ▶ Make the required settings for sending DTMF signals:

Audio or RFC 2833	DTMF signals are to be transmitted acoustically (in voice packets).
SIP Info	DTMF signals are to be transmitted as code.

Connection ringtones

Different ringtones are possible for internal, external, group, door, emergency and optional calls.

Prerequisite: The provider/platform sends the correct information via the Alert-Info field in the SIP header.

The user can select different ringtones for specific calls at the handset. You can here define which different ringtones are allowed to be set by the user.

- ▶ In the **Name** field enter the name for the menu entry that should be shown in the handset menu.

Note: Internal calls cannot be changed.

- ▶ The **Alert-Info pattern** field contains the Info-Alert definition that must be contained in the SIP header to identify the appropriate call type.

Field is empty: The entry is not shown in the handset menu.

Settings for codecs

The voice quality of VoIP calls is mainly determined by the codec used for the transmission and the available bandwidth of your network connection. A "better" codec (better voice quality) means more data needs to be transferred, i.e. it requires a network connection with a larger bandwidth. You can change the voice quality by selecting the voice codecs your phone is to use, and specifying the order in which the codecs are to be suggested when a VoIP connection is established. Default settings for the codecs used are stored in your phone; one setting optimised for low bandwidths and one for high bandwidths.

Both parties involved in a phone connection (caller/sender and recipient) must use the same voice codec. The voice codec is negotiated between the sender and the recipient when establishing a connection.

Active codecs / Available codecs

The following voice codecs are supported:

G.722 Outstanding voice quality. The G.722 wideband voice codec works at the same bit rate as PCMA/PCMU (64 kbit/s per voice connection) but at a higher sampling rate (16 kHz). To enable wideband connections via G.722 you have to activate the codec explicitly on the **Telephony – VoIP** page (→ p. 83).

PCMA/PCMU (Pulse Code Modulation) Excellent voice quality (comparable with ISDN). The required bandwidth is 64 kbit/s per voice connection.

PCMA (G.711 a law): Used in Europe and most countries outside of USA.

PCMU (G.711 ? law): Used in USA.

G.729A Average voice quality. The necessary bandwidth is less than or equal to 8 kbit/s per voice connection.

Activate/deactivate a codec:

▶ Select the required codec from the **Available codecs/Active codecs** list and click on ← / →.

Define the sequence in which the codecs should be used:

▶ In the **Active codecs** list select the required codec and click on ↑ / ↓ to move it up/down.



Selection of codecs G.722 and G.729 influence the system capacity in direction to lower amount of parallel calls per base station.

Number of parallel calls per base station depending on codec

Codecs enabled	Number of calls
G711 only	10
G729 and G711	8
G722 and G729 and G711	5

RTP and Hold options

RTP Packetisation Time (ptime)

Length of time in milliseconds represented by the audio data in one packet.

▶ Select the size of RTP packets to send. Select between 10 / 20 / 30 ms.

Signalling options for 'Hold' in Session Description Protocol (SDP)

Call hold means that a user requests to put an active call on hold. The holding part sends a re-INVITE request to the held client with an SDP offer (Session Description Protocol). This SDP offer contains the attribute line a=inactive or a=sendonly.

▶ Select which attribute should be sent in the SDP offer:

inactive The SIP endpoint would neither send nor receive data.

sendonly The SIP endpoint would only send and not receive data.

Hold towards Transfer-Target

The device enables call transfer after consultation or without consultation.

- ▶ Define, whether a consultation call with transfer target is put on-hold prior to the execution of the call transfer (**Yes**) or not (**No**).

Display of caller information

- ▶ From the option menu **Calling Party (User Part)** select which information is allowed to be transferred to the receiving part within the SIP header. Which information is actually transferred is determined by the provider.

Parameters

FROM	Only the FROM information can be added. Caller identity in the form number@server, e.g.:12345678@192.168.15.1
PPI+FROM	P-Preferred-Identity (PPI) or FROM can be added The P-Preferred-Identity header field is used from a user agent to a trusted proxy to carry the identity the user sending the SIP message wishes to be used for the P-Asserted-Header field value that the trusted element will insert.
PAI (sip)+PPI+FROM, PAI (tel)+PPI+FROM, PAI (tel)+FROM+PAI (sip)	P-Asserted-Identity (PAI) or PPI or FROM can be added PAI (sip): The P-Asserted-Identity header field is used among trusted SIP entities (typically intermediaries) to carry the identity of the user sending a SIP message as it was verified by authentication. PAI (tel): Instead of the SIP URI, the TEL URI (telephone number) is transmitted.

Service Codes

Service codes are key sequences provided by the provider or PBX in order to activate/deactivate specific functions on the handset. You can set the adequate service codes for activating/deactivating CCBS and CCNR.

CCBS	(Completion of Call to busy Subscriber)	Ringback if busy
CCNR	(Completion of Calls on No Reply)	Ringback if no answer

- ▶ In the text fields **Call Completion on (CCBS, CCNR)/Call Completion off (CCBS, CCNR)** enter the key sequence for activating/deactivating CCBS and CCNR.

CSTA

Computer Supported Telecommunications Applications is a standard for the interaction between a computer and a PBX, independently from the manufacturer. If your PBX provides CSTA applications to be used by the registered handsets you have to activate the standard here.

Account data for handset access can be configured for each handset (→ p. 79).

- ▶ Define, whether CSTA should be activated (**Yes**) or not (**No**).

Deleting the profile

- ▶ Click on **Delete** to delete the profile ▶ Confirm the operation with **Yes**.

Mobile devices

You can use the web configurator to register all handsets at the DECT network and for a VoIP connection. Use the add function of the **Administration** page to register single handsets or use the **Registration Centre** to register groups of handsets in one process.

You can edit the settings for handsets, deactivate or delete them and make further settings e.g., for using directories and network services.











Mobile devices administration

This page allows you to register single handsets to the phone system.

It is available in the Integrator user interface for both the user role **admin** and **user**.

► **Settings** ► **Mobile devices** ► **Administration**

The currently registered handsets and place holders for handsets that could be registered are listed on the page with the following information:

IPUI	International Portable User Identity used in order to uniquely identify a handset within the DECT network.										
Username	User name from the SIP account that is assigned to the handset, usually the phone number. The name is displayed on the handsets when they are in idle status. The setting can be changed.										
Display name	Display name from the SIP account that is assigned to the handset. The display name indicates the originator of the request when the user initiates a call.										
Location	Name of the DECT manager the handset belongs to. The symbol  indicates that the DECT manager is currently disconnected.										
DECT	DECT registration state of the handset: <table> <thead> <tr> <th>Status</th> <th>Meaning</th> </tr> </thead> <tbody> <tr> <td>To register</td> <td>System ready to register a handset</td> </tr> <tr> <td>Not registered</td> <td>Registration not possible</td> </tr> <tr> <td>Registering</td> <td>Registration in progress</td> </tr> <tr> <td>Registered</td> <td>Handset is registered The symbol  indicates that the handset is currently not reachable (powered down, battery removed, out of range, broken, stolen, ...)</td> </tr> </tbody> </table>	Status	Meaning	To register	System ready to register a handset	Not registered	Registration not possible	Registering	Registration in progress	Registered	Handset is registered The symbol  indicates that the handset is currently not reachable (powered down, battery removed, out of range, broken, stolen, ...)
Status	Meaning										
To register	System ready to register a handset										
Not registered	Registration not possible										
Registering	Registration in progress										
Registered	Handset is registered The symbol  indicates that the handset is currently not reachable (powered down, battery removed, out of range, broken, stolen, ...)										
SIP	Indicates, if the handset has a working VoIP connection. <table> <tbody> <tr> <td></td> <td>A VoIP connection is registered for the handset and a connection has been established successfully.</td> </tr> <tr> <td></td> <td>There is no VoIP connection configured or it is not possible to establish a connection to the configured VoIP provider.</td> </tr> </tbody> </table>		A VoIP connection is registered for the handset and a connection has been established successfully.		There is no VoIP connection configured or it is not possible to establish a connection to the configured VoIP provider.						
	A VoIP connection is registered for the handset and a connection has been established successfully.										
	There is no VoIP connection configured or it is not possible to establish a connection to the configured VoIP provider.										

DND	Indicates, if DND (Do not Disturb) is activated for the handset.
Type	Model designation of the handset.
FW	Current firmware version of the handset.
PIN	Authentication code defined for handset registration.

Actions

Adding a handset to the list

- ▶ Click on **Add** ... the mobile devices data page is opened.

Copying handset data for another configuration

- ▶ Select the check box next to the handset whose settings you want to copy. ▶ Click on **Copy** ... the mobile devices data page is opened. The settings of the selected mobile device except personal data are taken over for the new handset configuration.

Replace a mobile device for a user by another one

- ▶ Select the check box next to the handset of a user who should get another handset. ▶ Click on **Replace** ... the mobile devices data page is opened. The old mobile device will be set to **To deregister**. Personal provider data will be removed. User-specific data remain preserved. You will be prompted register a new mobile device.

Deleting a handset from the list

- ▶ Select the check box next to the handset you want to delete. Multiple choice is possible. ▶ Click on **Delete** ▶ Confirm with **Yes** ... all selected handsets are deleted.

Exporting/Importing the handset configuration

You can export the handset configuration and import it into another device, in order to change the DECT manager assignment, e.g., when migrating the multicell system from a single to a multiple DECT manager system (→ p. 123).

Exporting:

- ▶ Select all handsets you want to be transferred via the check mark next to the IPUI.
- ▶ Click on **Export** ▶ Select the location where the export file should be stored using the system file selection dialogue.

Importing:

- ▶ Click on **Import** ▶ Select the previously exported handset configuration file from your computer's file system.

Editing the data of a handset

- ▶ Click on  next to the handset you want to edit ... the mobile devices data page is opened.

Setting the name to be displayed in the idle display

By default, the **Username** is displayed in the handset's idle display. You can determine that the **Display name** should be used instead.

Registering/de-registering handsets

The page allows you to register a handset with the DECT network or to prepare the registration of numerous handsets via the Registration Center. You can assign a VoIP account, enable online directories, and make further settings for the handsets.

It is available in the Integrator user interface for both the user role **admin** and **user**.



Registration/de-registration in this context refers to the handset's relationship to the DECT network but not to SIP registration.

Registering handsets

- ▶ Enter an IPUI, if you want to restrict the registration to a specific handset.
- ▶ Enter an authentication code manually or generate it via the **Generate random PIN** button.
- ▶ Enter all configuration data for the handset.
- ▶ Click on **Register now**.

The handset with the matching IPUI is now allowed to register. If no IPUI is defined all handsets within range can register.



The system stays in registration mode as long as it is defined via the **Registration duration** parameter on the **Registration Centre** page. Default: 3 min.

On the handset

- ▶ Start the registration procedure as described in the appropriate documentation. ▶ When prompted, enter the PIN that has been entered or generated.

Registering a set of handsets

You can register a set of handsets without restarting the registration mode. Prepare registration for new mobile devices as follows:

- ▶ Enter the actual IPUI and maybe an individual PIN
- or
- ▶ Use wildcards as IPUI (0_1, 0_2, 0_3 ...) and preferably the same PIN for all handsets.
 - ▶ Set the **RegStatus** of the handsets to **To register**
 - ▶ Open the registration window for a desired time and register all handsets without further Web UI interaction via the **Registration Centre**.

Parameters

IPUI

(International Portable User Identity) Unique identifier of a handset within the DECT network. If you edit an existing handset registration entry, the IPUI is shown and cannot be changed.

For a new entry:

- ▶ Enter the IPUI of the handset that should be allowed to register with the DECT network in the text field.

If the field is empty, any handset will be allowed to register.

RegStatus

DECT registration status of the handset entry. The option menu allows you to change the status.

Status	Meaning / possible action to change the status
To register	The system is ready to register a handset using these settings. ▶ Select Not registered to disable registration.
Not registered	No registration possible. ▶ Select To register to allow a handset to register using these settings.
In registration	Registration in progress. ▶ Select Not registered to cancel the running registration process.
Registered	The handset is registered. ▶ Select To deregister to de-register the handset.

Authentication Code (PIN)

This PIN must be used on the handset to register with the DECT network.

- ▶ Enter a PIN in the text field. Value: 4 digits

or

- ▶ Click on **Generate random PIN** ... a four-digit PIN is generated and shown in the text field.

De-registering handsets

- ▶ In the handset list click on  next to the handset you want to de-register. The status is **Registered**.
- ▶ From the **RegStatus** option menu select **To deregister**. ▶ Click on **Set** ... the handset is de-registered.

DECT de-registration successful: The handset is deleted from the **Mobile devices** list.

DECT de-registration not successful: The handset stays in the **Mobile devices** list with status **To deregister**.

Settings for the handset

When registering a handset you can define important settings and assign functions at the same time.

Personal provider data

Configure the VoIP account for the handset. If the handset is successfully registered, ✓ will be shown in the **SIP** column in the **Mobile devices** list.



The VoIP/PBX account must be set-up beforehand.

VoIP provider

- ▶ Choose a configured VoIP PBX/provider from the option menu.
The connection must be configured on the **Provider or PBX profiles** page.
- ▶ Enter the access data for the VoIP account in the relevant fields. These fields may vary depending on the PBX/provider profile.

Authentication name

- ▶ Specify the SIP authentication name. The **Authentication name** acts as access ID when registering with the SIP proxy/registrar server. It is usually identical to the phone number for the VoIP account. Value: max. 74 characters, no spaces allowed

Authentication password

- ▶ Enter the password for SIP authentication. The phone needs the password when registering with the SIP proxy/registrar server. Value: max. 74 characters

Username

- ▶ Enter the caller ID for the VoIP provider account. It is usually identical to the phone number for the VoIP account. Value: max. 74 characters, no spaces allowed

Display name

The display name is used for presentation of the caller's name. In rare cases SIP networks check the display name for any local policy of the SIP network.

Usually, the display name is optional.

- ▶ Enter any name that should be shown for the caller on the other participant's display.
Value: max. 74 characters

If **Display name** is empty, the **Username** or the phone number will be used.



Do not use spaces in **Authentication name** and **Username**. Spaces may cause problems with SIP registration of the device.

Online directories

The user can call up various directories using the handset control or INT key.

Directory for direct access

The user can open a directory via the handset directory key (bottom of the control key). By default, **short** pressing the directory key opens the list of online directories, **long** pressing opens the local directory of the handset.

- ▶ Choose which directory should be called up by short pressing the directory key.

Online directories A list of online directories is opened by short pressing. Long pressing opens the local directory.

Local directory The local directory is opened by short pressing. Long pressing opens the online directories.

Directory for INT key

If any online directory is available and configured the user can open it by pressing the INT key (left on the handset's control key).

- ▶ Choose from the list which directory is opened with the INT key.

Automatic look-up

- ▶ Select an online directory from the list for **Automatic look-up** or deactivate this option. When there is an incoming call, the caller's name is read from this directory and shown in the display (the availability of this function depends on the online directory provider).

LDAP authentication

Up to 10 directories in LDAP format can be provided by the phone system. The access to a corporate directory can be provided individually for specific handsets.

Selected LDAP book

- ▶ Select the LDAP directory to be provided on the handset from the option menu.



At least one LDAP directory must have been set-up.

Show other LDAP servers

- ▶ Select **Yes** if directories of other LDAP servers should be allowed to be shown.

LDAP authorisation type

- ▶ Select how the user authentication should be performed:

Global Credentials are set for all handsets during the LDAP directory set-up.

User Individual credentials are used.

- ▶ Enter **Username** and **Password** in the appropriate text fields.

SIP The credentials for the user's SIP account are used (**Authentication name** and **Authentication password**).

Network mailbox configuration

If a network mailbox is available for the VoIP account assigned to the handset, you have to activate this function.

- ▶ Enter the **Call number or SIP name (URI)** for the network mailbox.
- ▶ Activate the function via the **Activate network mailbox** check box.

Group pick-up

Group pick-up enables a user to accept a call for another subscriber, e.g., a pick-up group. Users belonging to the same call pick-up group can accept all calls for the group. A pick-up group must be established during SIP account registration. The call number or the SIP URI of a pick-up group can be assigned to the mobile device.

- ▶ Enter the **Call number or SIP name (URI)** of the pick-up group.
- ▶ Activate the function via the check box.

Call manager

- ▶ From the option menu select, whether calls that are initialised by a PBX call manager are to be accepted directly:
 - via Headset** To accept the call the handset automatically activates the connected headset.
 - via Handsfree** To accept the call the handset automatically activates the speaker phone function.
 - No** The call is not accepted automatically at all.



Direct call acceptance requires a secured signalling to the PBX (TLS).

Accepting calls via a Call Manager has no impact on the DECT system performance, because it is handled on SIP level.

Missed calls and alarms

You can define if missed and accepted calls should be counted and if new messages of specific types should be indicated via the MWI LED on the handset's message key.

- ▶ Select **Yes/No** next to **Missed calls count/Accepted calls count**, to activate/deactivate the call counter for missed and accepted calls. The information is displayed in the handset's call lists, missed calls are also shown on the handset's idle display.
- ▶ Select **Yes/No** next to the message type (missed calls, missed alarms, new message on the network mailbox), to activate/deactivate the MWI LED for the message type.
If **Yes** is selected, the message key will flash, if a new message of the selected types is received.

CSTA

CSTA (Computer Supported Telecommunications Applications) is a standard for the interaction between computer and PBX, independently from the manufacturer. If the provided CSTA applications require individual access control you can enter the access data for the handset here.



CSTA must be provided by your PBX and must be activated in the provider/PBX profile (→ p. 72)

Username

- ▶ Enter the user name for the handset's access to CSTA applications.

Authentication name

- ▶ Specify the authentication name for the handset's access to CSTA applications.

Authentication password

- ▶ Enter the password for the handset's access to CSTA applications.

Broadsoft XSI services

If BroadSoft XSI services should be provided to the user on the handset, enter the credentials.



XSI services must be activated (→ p. 87).

Use SIP credentials

If activated, the credentials for the user's SIP account (**Authentication name** and **Authentication password**) are used.

Alternatively, define the following credentials.

Username

- ▶ Enter a user name for the user access to the menu (max. 22 characters).

Password

- ▶ Enter a password for the user access to the menu (max. 8 characters).

Feature key synchronisation

This option permits the users to use keys on their phones to handle Do Not Disturb and Call Forwarding. If activated, the phones synchronise with the BroadWorks Application server on the status of these features.

- ▶ Select **Yes/No**, to activate/deactivate key synchronisation with the BroadWorks Application server.

Provisioning and configuration

With this function you initialise the handset settings manually without having to wait for the automatic provision. You can use it to check whether all settings are correctly adopted.



The handset provisioning must be enabled. A provisioning server must have been set up on the **Settings – System – Provisioning and configuration** page.

Provisioning server

Shows the URL of your provisioning server.

Last sync time

Shows the time at which the last synchronisation was carried out.

Start auto configuration

- ▶ Click on the button ... the provisioning of the handset settings is started.

The button is enabled, if the IPUI is set.

You receive a message, if the process was successful or not.

Use an AML license for the handset

You can activate/deactivate the alarm features **Location** and/or **Messaging** for the handset.



The online service AML must be set up and there must be free licenses for the handset.

Show free licenses: ▶ Guide pointer over the check boxes ... The number of available and used licenses is displayed.

Location

- ▶ Enable/disable cooperation with the location/alarm server. If enabled, the location of the handset is visible on the server.

Messaging

- ▶ Enable/disable cooperation with the alarm server. If enabled, messages from the alarm server can be sent to the handset and reactions from the user can be sent back to the server.

Mobile devices – Registration Centre

The registration centre allows you to register groups of handsets in one registration process. All handsets which are listed in the mobile devices list and have the registration status **To register** or **Registering** can be registered together.

It is available in the Integrator user interface for both the user role **admin** and **user**.

- ▶ **Settings ▶ Mobile devices ▶ Registration Centre**

The page shows the number of mobile devices in registration status **To register**, **Registering** and the total number of entries in the mobile devices list, including those in registration status **Registered** and **Not registered**.

Additionally, the page shows the total amount of DECT managers and DECT managers that are currently ready to register handsets. DECT managers are set in registration status **Registering** when a registration process is started automatically according to the time settings on this page or when registering handsets manually.

Registering handsets time-controlled

Current time

Shows the current system time.

Registration start time

- ▶ Enter the time when the next registration process should be started. Format: YYYY-MM-DD HH:mm.
- ▶ Click on **Start now**. ... the DECT manager starts a registration process at the given time. If no time is set, the DECT manager will start registration at once.

Setting the registration duration

- ▶ In the **Registration duration** fields determine how long (days, hours, minutes and seconds) the DECT manager should stay in registration mode. Default: 3 min.

Closing the window and resetting the timers

- ▶ Click on **Close** ... the registration window is closed, the time settings are reset.



When the first handset tries to register, the base closes the registration window and finalises the registration within a very few seconds. During this time any second handset registration attempt would be rejected. When the first handset is fully registered the base re-opens the registration window as long as defined with the **Registration start time** and **Registration duration** parameters.

If all handsets try to register in parallel, a lot of them will enter the base one by one and so will be successfully registered, but others might enter while another registration is not yet completed and so they will be rejected.

Single handsets that are rejected have to be registered by a new registration procedure or manually.

Telephony settings

General VoIP settings

This page allows you to make some general settings for the VoIP connections.

It is only available in the Integrator user interface for the user role **admin**.

▶ **Settings ▶ Telephony ▶ VoIP**

SIP port

▶ Enter the SIP port used for VoIP connections.

Range: 1-65535; Default: 5060

Secure SIP port

▶ Enter the SIP port used for secure VoIP connections (TLS).

Range: 1-65535; Default: 5061

SIP timer T1

▶ Enter the estimated round trip time of an IP packet between a SIP client and a SIP server (the time it takes between sending out the request to the point of getting a response).

Default: 500 ms

SIP session timer

▶ Defines a session expiry interval: If the session isn't refreshed within the interval, the session is released. Session refresh is started after half of the interval by a re-INVITE message, which the peer side has to confirm to get the session refreshed.

Values: max. 4 digits, min. 90 sec; Default: 1800 sec

Failed registration retry timer

▶ Specify after how many seconds the phone should attempt to re-register when the initial registration has failed.

Values: max. 4 digits, min. 10 sec; Default: 300 sec

Subscription timer

▶ Defines the expiration time (in seconds) of a subscription. In order to keep subscriptions effective, subscribers need to refresh subscriptions on a periodic basis.

Default: 1800 s

PRACK

▶ (Provisional Response Acknowledgement) SIP provisional responses do not have an acknowledgement system so they are not reliable. The PRACK method guarantees a reliable and ordered delivery of provisional responses in SIP.

Security settings

The phone system supports the establishment of secure voice connections over the internet via TLS certificates. Thereby, public and private keys are used to encrypt and decrypt the messages that are exchanged between SIP entities. The public key is contained within the certificate of an IP entity and is available for everyone. The private key is kept secret and is never revealed to anyone. The server certificate and the private key must be uploaded to the base stations.

- ▶ Click on **Browse...** and choose the file containing the certificate or the private key from the file system of your computer or network ▶ click on **Upload** ... the file is uploaded and shown in the appropriate list.

SIP security password

- ▶ If your private key is protected by a password, enter it here.

Quality of Service (QoS)

The voice quality depends on the priority of the voice data in the IP network. Prioritising the VoIP data packets is done using the QoS protocol DiffServ (Differentiated Services). DiffServ defines a number of classes for the quality of service and, within these classes, various priority levels for which specific prioritisation procedures are defined.

You can specify different QoS values for SIP and RTP packets. SIP packets contain the signalling data, while RTP (Real-time Transport Protocol) is used for the voice transfer.

- ▶ Enter your chosen QoS values in the **SIP ToS / DiffServ** and **RTP ToS / DiffServ** fields.
Value range: 0 - 63.

Common values for VoIP (default setting):

SIP	34	High service class for fast switching of the data flow (Expedited Flow)
RTP	46	Highest service class for fast forwarding of data packets (Expedited Forwarding)



Do not change these values without consulting your network operator first. A higher value does not necessarily mean a higher priority. The value determines the service class, not the priority. The prioritisation procedure used in each case meets the requirements of this class and is not necessarily suitable for transferring voice data.

Audio quality

The phone system allows the user to make calls with excellent voice quality using the wideband codec G.722. One base station enables a maximum of five wideband calls.

The page allows you to enable/disable the use of the wideband codec G.722 for the telephone system.

It is only available in the Integrator user interface for the user role **admin**.

- ▶ **Settings ▶ Telephony ▶ Audio**
- ▶ Mark/unmark the check box to enable/disable wideband calls
- ▶ Click on **Set** to save the settings of this page.



To allow users to make wideband calls, the codec G.722 must have been activated for the provider profile that is used for the connection (➔ p. 70).

Call settings

On this page you can make advanced settings for VoIP connections.

It is only available in the Integrator user interface for the user role **admin**.

▶ **Settings** ▶ **Telephony** ▶ **Call settings**

Call transfer

Participants can transfer a call to another participant as long as the PBX/provider supports this function. The call is transferred using the handset menu (via the display key) or using the R key. You can expand or change the settings for call transfer.

Call transfer via R key

Activated: Users can connect two external callers with each other by pressing the R key. The connections with both parties are terminated.

Transfer call by on-hook

Activated: The two participants are connected with one another when the user presses the end call key. The intermediary's connections with the participants are terminated.

Determine target address

▶ Select how the transfer target address (Refer-To URI) is to be derived:

From transfer target's AOR (Address of Record)

From transfer target's transport address (Contact URI)

Most common PBX platforms show good results by using the AOR as transfer target address.

In case there are problems with transfer especially via transparent proxies, rather than call switching PBX, it might be worthwhile to test with transfer target address derived from transfer target's transport address.

Access Code

You may have to enter an access code for external calls (external prefixes e.g., "0"). You can save this access code in configuration. These settings apply to all registered handsets.

Access Code

▶ Enter an access code in the text field. Value: max. 3 digits (0 – 9, *, R, #, P)

is added to numbers

▶ Select when the phone numbers should be automatically prefixed with the digits, e.g. when dialling from a call list or a directory.

Area Codes

If you use VoIP to make a call to the fixed line, you may also have to dial the area code for local calls (depending on the provider).

You can set your telephone system so that the access code is automatically predialled when any VoIP call is made in the same local area, and also for national long-distance calls. This means that the access code is set before all phone numbers that do not start with 0 – even when dialling numbers from the directory and other lists.

You can change these settings if required.

Country

- ▶ From the option menu select the country or region where your telephone system is to be used ... the international and national prefix is then entered in the **Prefix** and **Area code** fields.

International settings

Prefix Prefix of the international area code. Value: max. 4 digits, 0-9

Area code International area code. Value: max. 4 digits, 0-9

Example "Great Britain": **Prefix** = 00, **Area code** = 44

Local settings

Prefix Prefix of the local area code. Value: max. 4 digits, 0 - 9. These digits are placed in front of the local area code for national long-distance calls.

Area code Local area code for your town/city (depending on country/provider). Value: max. 8 digits, 0-9

Example "London": **Prefix** = 0, **Area code** = 207

Use area code

- ▶ Select from the option menu when the area code is to be prefixed to the call number:
For local calls, **For local and national calls** or **No** (never)

Tone Selection

Tones (e.g., dialling tone, ring tone, busy tone or call waiting tone) vary from one country or region to another. You can choose from various tone groups for your telephone system.

Tone scheme

- ▶ Select the country or region whose ring tones are to be used for your phone from the option menu.

XSI services

BroadSoft XSI (Xtended Service Interface) allows remote applications to integrate with BroadSoft services to perform telephony-related actions and to be notified about telephony events. The phone system enables the use of XSI services to provide the user with XSI directories and call lists.

If you want to use XSI services, you need to enable the services and enter the XSI server address on this page.

It is only available in the Integrator user interface for the user role **admin**.

▶ **Settings ▶ Telephony ▶ XSI Services**

Server address

▶ Enter the URL of the XSI server in the text field.

Enable XSI directories

▶ Mark the check box, if you want to use XSI directories. Specific XSI directories must be set up as online directory on the XSI page.

Enable XSI call logs

▶ Mark the check box, if you want to use XSI call logs.

Online directories

N870 IP PRO allows you to set up up to ten corporate directories in LDAP format, a public and a corporate directory in XML format, different XSI directories, as well as a central directory and make them available to the registered handsets.

Use the handset settings to specify which keys are to call up the directories.

Corporate online directories (LDAP)

You can set up up to ten corporate directories in LDAP format for the phone system and make one of them available to the registered handsets. If you wish to use a company directory on the telephone system, you must activate it on the Web configurator.

The page lists the available LDAP directories.

It is only available in the Integrator user interface for the user role **admin**.

► **Settings** ► **Online directories** ► **Corporate**

Name	The name that you have defined for the directory is displayed, or the default name (LDAP1 - LDAP10). It can be edited.
Server url	If the directory is configured, the server URL is displayed.
Activation status	Indicates if the directory is activated or not.
	<input checked="" type="checkbox"/> The directory is activated. <input type="checkbox"/> The directory is not activated.

Configuring LDAP directories

► Click on  next to the name of the LDAP directory you want to edit ... the LDAP configuration page is opened.



Detailed information about LDAP configuration can be found at wiki.gigaset.com

Configuring an LDAP directory

On this page you can edit the data for the selected LDAP directory.

It is only available in the Integrator user interface for the user role **admin**.

Access to the LDAP data server

The directory is provided via an LDAP server. You need the server address, the server port and the access data for the directory that you wish to use.

- Enter a name in the field (max. 20 characters). This is the name under which the directory will be displayed on the handsets.
- Mark the **Enable directory** option, so that the directory is displayed on the telephones.

Server address / Server port

- ▶ Enter the URL of the LDAP server.
- ▶ Enter the port the LDAP server expects database requests (Default: 389)

LDAP Search base (BaseDN)

- ▶ The LDAP database is hierarchical in design. With the **LDAP Search base (BaseDN)** parameter, stipulate in which area the search should begin.

Default: 0, the search starts at the upper area of the LDAP database.

User access data

If you want to define access data that have to be used by all users:

- ▶ Enter the access data for the LDAP directory in the **Username** and **Password** fields (max. 254 characters each).

If you want to use individual access data for each handset, the access data is to be set during the handset configuration.

Secure LDAP

By default, LDAP traffic between the phone system and the LDAP directory server is handled via an insecure connection. You can encrypt traffic by enabling secure LDAP. This is accomplished by installing a CA certificate signed by the secure LDAP server onto the system.

- ▶ Select the security protocol **SSL/TLS** or **STARTTLS** to be used for encryption or **None** to dispense with encryption.

Settings for searching the LDAP database and displaying the result**Enable list mode**

- ▶ Define what should be initially shown, when the user opens the LDAP directory.

Activated: A list of all entries of the LDAP directory is shown.

Not activated: An editor is opened first that allows the user to select a specific search area within the LDAP database and thereby to reduce the number of entries.

Filters

Using the filters, you can define criteria against which specific entries can be searched in the LDAP database. One filter consists of one or more search criteria. A search criterion contains the query for an LDAP attribute.

Example: `sn=%`

The `sn` attribute stands for surname. The percent sign (%) is a place holder for the user entry.

Rules for defining filters:

- Multiple criteria can be connected using logical AND (&) and/or OR (|) operators.
- The logical operators "&" and "|" are placed before the search criteria.
- The search criterion must be placed in brackets and the whole expression must be terminated with a bracket again.
- AND and OR operations can be combined.

Examples:

AND operation: (& (givenName=%) (mail=%))

Searches for entries in which the first name **and** mail address begin with the characters entered by the user.

OR operation: (| (displayName=%) (sn=%))

Searches for entries in which the display name **or** surname begins with the characters entered by the user.

Combined operation: ((& (displayName=%) (mail=%))(& (sn=%) (mail=%)))

Searches for entries in which the display name **and** mail address **or** the surname **and** mail address begin with the characters entered by the user.

Information on attributes → p. 91

Name filter

The name filter decides which attribute is used for the search.

Example:

(displayName=%). The percent sign (%) is replaced by the name or part of the name entered by the user.

If a user enters the letter "A", for example, all entries in which the attribute **displayName** begins with "A" are searched for in the LDAP database. If the user then enters a "b", entries are searched in which the **displayName** begins with "Ab".

Number filter

The number filter stipulates the criteria for the automatic completion of telephone numbers.

Example:

((telephoneNumber=%)(mobile=%)). The percent sign (%) is then replaced by the part of the telephone number entered by the user.

When dialling, if a user enters the numbers "123", for example, all telephone numbers that begin with "123" are searched for in the LDAP database. The telephone number is completed with the addition of information from the database.

Additional filters

You can set two additional filters that will be offered to the user in order to specify the search more detailed.

- ▶ In the additional name fields enter the attribute name.
- ▶ In the corresponding value fields enter the attribute values.

Example:

Additional filter #1 name	City
Additional filter #1 value	((!l=%))
Additional filter #2 name	Street
Additional filter #2 value	((!street=%))

In addition to the fields defined in the **Name filter** parameter, the **City** and the **Street** fields are provided to the user. The user input for **City** is passed to the LDAP server in the **l** attribute, the user input for **Street** is passed in the **street** attribute.

Display format

In the **Display format** field you can stipulate how the search result is to be displayed on the handset.

- ▶ Enter combinations of different name and number attributes and special characters. You can select common formats from the attributes that are listed in the **Configuration of directory items** section of the page.

For the attribute values to be shown for the required attribute, the attribute name must be preceded by a percent sign (%).

Example:

Data of an directory entry on the LDAP server:

displayName	Peter Black	telephoneNumber	0891234567890
givenName	Peter	mobile	012398765432
sn	Black		

...

Attribute definition in the Web configurator:

Display format %sn, %givenName; %telephoneNumber/%mobile

The entry is shown on the handset as follows:

Black, Peter; 0891234567890/012398765432

Max. number of search results

- ▶ Enter the maximum number of search results that is to be returned by one search operation.

Attributes

A range of attributes are defined in the LDAP database for a directory entry, e.g. surname, first name, telephone number, address, company, etc. The quantity of all attributes which can be saved in one entry is stored in the relevant LDAP server scheme. In order to be able to access attributes or define search filters, you must know the attributes and their designation in the LDAP server. The majority of attribute designations are standardised, however specific attributes can also be defined.

- ▶ For each field of a directory entry that should be displayed on the handsets enter the name of the corresponding LDAP attribute. Multiple attributes can be separated by commas.

Examples:

Field of a directory entry	Attribute name in the LDAP database
First name	givenName
Surname	sn, cn, displayName
Phone (home)	homePhone, telephoneNumber
Phone (office)	telephoneNumber
Phone (mobile)	mobile
E-mail	mail
Fax	facsimileTelephoneNumber
Company	company, o, ou

Field of a directory entry	Attribute name in the LDAP database
Street	street
City	l, postalAddress
Zip	postalCode
Country	friendlyCountryName, c
Additional attribute	user-defined

▶ Mark the check box, if an additional attribute is defined and it is a phone number.

A detailed configuration example can be found in section "LDAP directory – configuration example" → p. 130

LDAP configuration with Windows Active Directory server

Active Directory Domain Services (AD DS) is the directory service for Windows server. In a multi-domain AD DS forest (container within an Active Directory configuration containing domains, users, hosts and group policy) the Global Catalog is a distributed data repository that contains a searchable, partial representation of every object in every domain. The global catalog is stored on domain controllers that have been designated as global catalog servers and is distributed through multi-master replication. Searches that are directed to the global catalog are faster, because they do not involve referrals to different domain controllers.

In addition to configuration and schema directory partition replicas, every domain controller in a forest stores a full writeable replica of a single domain directory partition. A domain controller can locate only the objects in its domain. Locating an object in a different domain would require the user or application to provide the domain of the requested object.

To use an LDAP directory provided via Active Directory service you can use the following ports:

Default ports: 389 (LDAP) / 636 (LDAPS)

These ports are used for requesting information from the local domain controller. LDAP requests sent to port 389/636 can be used to search for objects only within the global catalogues home domain. However, the requesting application can obtain all of the attributes for those objects.







Default ports: 3268 (LDAP) / 3269 (LDAPS)

These ports are used for queries specifically targeted for the Global Catalog. LDAP requests sent to port 3268/3269 can be used to search for objects in the entire forest. However, only the attributes marked for replication to the Global Catalogue can be returned.

Online directories in XML format

A public and/or a corporate online directory in XML format can be made available to the user. It is only available in the Integrator user interface for the user role **admin**.

► **Settings** ► **Online directories** ► **XML**

Name	The name that you have defined for the directory is displayed, or the default name (Public/Corporate). It can be edited.				
Server url	If the directory is configured, the server URL is displayed.				
Activation status	Indicates if a directory and what kind of directory is activated.				
	<table> <tr> <td></td> <td>The directory is activated.</td> </tr> <tr> <td></td> <td>The directory is not activated.</td> </tr> </table>		The directory is activated.		The directory is not activated.
	The directory is activated.				
	The directory is not activated.				

Configuring XML directories

- Click on  next to **Public** or **Corporate** ... the XML directory configuration page is opened.

Entering the data for an XML directory

Use this page to enter the provider's details and a name for the directory.

Directory name

- Enter a name for the directory. This is the name that will be displayed on the handsets when the user opens the directory list by pressing the directory key.

Server address

- Enter the URL of the online directory provider.

Username / Password

- Enter the access data for the online directory in the **Username** and **Password** fields.

List update / refresh

- Activated: The result list at the handset will automatically request the next portion of results when browsing through it.
- Not activated: The number of entries defined in **Maximum number of entries** is downloaded during one reading operation.

Enabling online directories

You can enable/disable different kinds of public directories (White Pages, Yellow Pages or Public Private Pages) that are provided by the given provider.

- Mark/unmark the check box next to the public directory you want to enable/disable.

Online directories – XSI

If one or more online directories are provided via an BroadSoft XSI service, use this page to set up the server access, enable the directories and assign directory names that are to be displayed on the users' handsets.

It is only available in the Integrator user interface for the user role **admin**.



The XSI directory service must be enabled on the **Telephony – XSI Services** page (→ p. 87).

▶ Settings ▶ Online directories ▶ XSI

Server address

If XSI services are enabled the address of the XSI server is shown here.

Enable list mode

- ▶ Define what should be initially shown, when the user opens the phone book.

Activated: A list of all entries of the phone book is shown.

Not activated: An editor is opened first that allows the user to select a specific search area within the phone book and thereby to reduce the number of entries.

Enable XSI directories

- ▶ Mark the check box, if you want any of the following XSI directories to be provided on the users' handsets.

Enable specific XSI directories

- ▶ Mark the check box next to the XSI directories that should be provided.

Directory name

- ▶ For the selected XSI directories enter a name in the **Directory name** field. This is the name under which the directory will be displayed on the handsets.

Central phone book

You can provide a central phone book for all users' handsets. The phone book can be provided via a server in the network or uploaded directly from a computer to the phone system.

It is only available in the Integrator user interface for the user role **admin**.

The phone book must be available in well-defined XML format. For detailed information please refer to wiki.gigaset.com

▶ **Settings** ▶ **Online directories** ▶ **Central phonebook**

Directory name

- ▶ Enter a name for the phone book in the **Directory name** field. This is the name under which the phone book will be displayed on the handsets.
- ▶ Mark the **Enable directory** option, so that the directory is displayed on the handsets.

Server address

- ▶ Enter the URL of the server providing the phone book in the text field.

Daily refresh time

The phone book will be refreshed automatically once a day.

- ▶ Enter the time when the automatic refresh should take place.

Max. number of search results

- ▶ Enter the maximum number of search results that is to be returned by one search operation.

Enable list mode

- ▶ Define what should be initially shown, when the user opens the phone book.

Activated: A list of all entries of the phone book is shown.

Not activated: An editor is opened first that allows the user to select a specific search area within the phone book and thereby to reduce the number of entries.

Load the phone book from PC

You can download an XML phone book from your computer directly to the phone system.

Phonebook file

- ▶ Click **Browse...** and select the XML phone book file from your computer's file system ▶ click on **Upload** ... the selected file is loaded and can be made available for the users.

Save the phone book to PC

You can backup the central phone book to your computer.

- ▶ Click on **Save phonebook** ▶ Select the location where the phone book should be stored using the system file selection dialogue. Enter a name for the phone book backup file.

Delete the phone book

- ▶ Click on **Delete phonebook** to remove the phone book from the handsets.



A search in the central telephone book returns all entries that contain the characters entered by the user somewhere in the first or last name.

Alternatively, the following can be set via provisioning: Only those entries are returned that have the entered characters at the beginning.

Detailed information about provisioning parameters can be found at wiki.gigaset.com.

Online services

XHTML

Additional functions as Info services, PBX control, and customer specific RAP (XHTML) applications can be made available to the user via the handset menu **Info Centre**. For this purpose four additional menu entries can be defined that will be inserted into the handset user interface.

The additional functions must be available as well formatted XHTML pages. For information on the supported XHTML format, please visit wiki.gigaset.com.

The page is only available in the Integrator user interface for the user role **admin**.

▶ **Settings** ▶ **Online services** ▶ **XHTML**

The page shows the following information for the defined menus:

Name	The name that you have defined for the menu is displayed.
Display key	Name of the display key on the handset with which the function is triggered.
Server url	If the XHTML access is configured, the server URL is displayed.

Add SIP-ID

If the option is enabled, the device will add the SIP ID in the GET request that are addressed to the server.

▶ Mark the check box **Add SIP-ID** in order to activate the option.

Adding / editing an entry

You can define up to four menu entries.

▶ Click on  in an empty row or in a row with an already configured entry in order to edit it.

Activate

▶ Mark the option, so that the menu is displayed on the handsets.

Name for menu

▶ Enter a name in the text field (max. 22 characters). This is the name under which the menu will be displayed on the handsets.

Name for display key

▶ Enter a name in the text field (max. 8 characters). This is the name under which the display key function will be displayed on the handsets.

Server address

▶ Enter the URL of the server providing the service.

The access to the service can be protected by user name and password.

Use SIP credentials

If activated, the credentials for the user's SIP account are used (**Authentication name** and **Authentication password**).

Alternatively, the following credentials can be used.

Username

- ▶ Enter a user name for access to the menu.

Password

- ▶ Enter a password for access to the menu.

Application Server

The phone system supports the AML feature (Alarming - Messaging - Location). AML includes the following functions:

- Alarming:** The user can start an alarm from the DECT handset. The alarm is forwarded to an alarm server.
- DGUV support:** DGUV-compliant protection of employees working alone in dangerous situations with the aid of special DECT devices. For example, alarms that are triggered in certain cases: "man down" function triggered, emergency button pressed, explosion, detached cable.
- Messaging:** Messages from an alarm server (or another server/platform) are sent to the DECT handsets. Reactions from users can be sent back to the server.
Messages may contain an icon (coloured) if the DECT phone supports this, e.g. for fire alarm, nurse call, . . . Prioritised messages can be signalled with specific different ringtones.
- Location:** The location of a handset is made visible on an alarm server. The alarm server can show visited and neighbouring base stations including signal strength.



A licence is required for each handset that is to receive messages from an alarm server or that is to send location data.

Detailed information about working with application servers and AML can be found at wiki.gigaset.com.

On this page you enter the servers to be used for AML.

This page is only available in the Integrator user interface for the user role **admin**.

▶ Settings ▶ Online services ▶ Application Servers

The page shows the following information about the servers:

- AS Id** Automatically assigned ID for the application server.
- AS Name** Name you can set for the server.

Actions

Adding an application server

- ▶ Click on **Add** ... the application server page is opened.

Deleting an application server from the list

- ▶ Select the check box next to the application server you want to delete. Multiple choice is possible. ▶ Click on **Delete** ▶ Conform with **Yes** ... all selected application server are deleted.

Editing the data of an application server

- ▶ Click on  next to the application server you want to edit ... the application server configuration page is opened.

Adding/editing an application server

AS Id

- ▶ ID that external clients need for access. The ID is automatically assigned as soon as you set up an entry for the application server.

Application server name

- ▶ Enter the user name for accessing the server in the text field.

Password

- ▶ Enter a password for accessing the server (min. 32 characters).

System settings

Web configurator access rights

On this page you define the access rights for the web configurator user interface.

It is available in the Integrator and DECT manager user interface for both the user role **admin** and **user**. The user is only allowed to change the own password.

▶ **Settings** ▶ **System** ▶ **Web configurator**

Changing the web configurator password

For security reasons, you should frequently change the password for web configurator access.

There are two user roles with different user IDs, **admin** and **user** (⇒ p. 28). The **user** ID is disabled by default. You can activate it here.

The password is set depending on the user role. The administrator is allowed to change the password for both **admin** and **user**. Logged on as **user** you can only change the password for **user**.



If you have forgotten the password, you will have to reset the device to the factory settings (⇒ p. 25).

New password

- ▶ Enter a new password for the administrator/user access to the web configurator.
Default: **admin/user**

Repeat password

- ▶ Repeat the new password entered in the **Repeat password** field.

Show password

- ▶ To view the entered characters mark the check box near **Show password**.

Change password for all DECT Managers

- ▶ Click on the button to change the administrator password for all DECT managers.

Activate user access

- ▶ Click on **Yes/No** to enable/disable the ID for the **user** role.
- ▶ Enter a new password for the user access to the web configurator and repeat it.

Enabling CLI access to the device configuration

Only available in the Integrator user interface for the user role **admin**.

It is possible to perform the device configuration via CLI (Command Line Interface) using SSH from a remote system. Secure Shell (SSH) is a program for logging into a remote machine and for executing commands on a remote machine. It provides secure encrypted communications between two untrustworthy hosts over an insecure network.

Detailed information on CLI commands can be found in the online help of the web configurator.

Activated if password is longer than 7 characters

The CLI access is automatically enabled if you have entered a valid password that has more than seven characters and click on the **Set** button. ✓ = enabled; ✗ = disabled

CLI password

- ▶ Enter a password for the administrator access to the configuration via SSH. Value: min. 8, max. 74 characters



The user name for the CLI access is **cli**.

Repeat password

- ▶ Repeat the new password entered in the **CLI Password (Admin)** field.

Show password

- ▶ To view the entered characters mark the check box next to **Show password**.

Loading the web security certificate

Only available in the Integrator user interface for the user role **admin**.

The web configurator is protected by SSL/TLS security mechanism. That means that data transfer is encrypted and that the website is identified to be who it claims to be. The Internet browser checks the security certificate to determine that the site is legitimate. The certificate may be updated from time to time. If a new certificate is available you can download it to your computer or network and then upload it to the device.

- ▶ Click on **Browse...** next to **Web security certificate** and select the local certificate file from your computer's file system ▶ click on **Upload** ... the selected certificate file is loaded and added to the certificate lists.
- ▶ If the certificate requires a password, enter it in the **Web security password** field.

Licensing

For large installation and enterprise solutions licenses are needed.

The page is only available in the user interface of a virtual integrator or on devices with the role **Integrator only** and for the user role **admin**.

► Settings ► System ► Licensing

The table shows the licenses that are currently in use.

Item under Licensing Features that are licensed.

Virtual Integrator

Used to use the integrator on a virtual machine.

DECT Manager - Multi cell

Used for up to 100 single cell devices to be used as DECT manager in an installation with a virtual integrator or up to four devices used in an installation with an embedded integrator.

Licenses for AML (Alarming, Messaging, Location)

Messaging

Enables cooperation with an alarm server (or other servers/platforms). Messages from an alarm server can be sent to the DECT handsets. Reactions from users can be sent back to the server.

Location

Enables cooperation with location/alarm servers. The location of an handset can be made visible on the server.

Each handset that is required to send location data needs an own handset location license.

The **Location** license includes a **Messaging** license.

Available Licences Feature quantity of the ordered licenses. During the activation period the maximum quantity is available.

Used Licences How many licenses are needed by the current configuration.

Status Remaining days of the activation period (or expired).

Showing detailed information on the license currently used

- Click on **Show licence status** ... the name of the license package, the license status and the activation time is shown.

Uploading the license file

Your distributor will send you the license activation file.

- Click on **Browse...** ► Select the previously saved license file from the file system of your computer. ► Click on **Upload** ... the license will be enabled.

Grace period

- After the first start-up and after each full factory reset an installation can be tested for 35 days without any limitation and any purchased license (grace period). In the **Status** column the remaining days of the grace period is shown.
- After 35 days the message **Check license status** will be shown on all registered handset for additional 35 days. The **Status** column shows **Grace period - expired**. The system will still stay fully functional.
- After a total number of 70 days after first startup/factory reset the number of parallel calls will be reduced to 1 call per connected DECT manager, unless a valid license file will be uploaded.
- The Messaging and Location licences do not have a grace period. Instead, test licenses for Messaging and Location are granted for one handset.

Master DECT manager

As the virtual integrator is not a physical device, a master DECT manager must be defined for licensing via DECT manager administration. The license is assigned to the MAC address of the master DECT manager.

If the master DECT manager is broken and replaced, the license is not valid anymore. You have one month to request a new license file.

Provisioning and configuration

This page allows you to define the provisioning server for the telephone system or download a configuration file and to start an auto-configuration process.

It is only available in the Integrator user interface for the user role **admin**.

Provisioning is the process for uploading the necessary configuration and account data to the VoIP phones (here the DECT bases). This is done by means of profiles. A profile is a configuration file that contains VoIP phone-specific settings, VoIP provider data as well as user-specific content. It has to be available on an HTTP provisioning server which is accessible in the public (Internet) or local network.

Auto-configuration is defined as the mode of operation by which the telephone system connects automatically to a server and downloads both provider-specific parameters (such as the URL of the SIP server) and user-specific parameters (such as the user name and password) and stores them in its non-volatile memory. Auto-configuration is not necessarily limited to the parameters required for doing VoIP telephony. Auto-configuration can also be used to configure other parameters, e.g. settings for online service, if the VoIP phones support these features. However, for technical reasons auto-provisioning is not possible for all configuration parameters of the phone.



Detailed information on how to establish a provisioning server and create provisioning profiles for Gigaset phones: → wiki.gigaset.com

► **Settings** ► **System** ► **Provisioning and configuration**

Provisioning server

- Enter the URL of your provisioning server in the text field. Value: max. 255 characters

Auto configuration file

If you have received a configuration file from your provider, you download it to the phone system.

- ▶ Click **Browse...** and select the configuration file from your computer's file system ▶ click on **Upload** ... the selected configuration file is loaded.

Start auto configuration

- ▶ Click on the button ... the provisioning profile is downloaded and installed on the system.



The process will take some time.

For security reasons you should save the configuration before you start an auto-configuration process.

Security

The page allows you to organise the certificates used for secure internet communication and to define the credentials for HTTP authentication.

It is only available in the Integrator user interface for the user role **admin**.

- ▶ **Settings** ▶ **System** ▶ **Security**

Certificates

The phone system supports the establishment of secure data connections on the Internet with the TLS security protocol (Transport Layer Security). With TLS, the client (the phone) uses certificates to identify the server. These certificates must be stored on the base stations.

Accept all certificates

- ▶ Mark the **Yes** radio button, if you want to accept all certificates.

Server certificates / CA certificates

The lists contain the server certificates or CA certificates that have been certified by a certification authority (CA). The certificates in both lists have already been implemented by default or have been downloaded via the Web configurator and are classed as valid, i.e., have been accepted.

If one of the certificates becomes invalid, e.g., because it has expired, it is transferred to the **Invalid certificates** list.

Invalid certificates

The list contains the certificates that have been received from servers but have not passed the certificate check, and certificates from the **Server certificates / CA certificates** lists that have become invalid.

Accepting / rejecting invalid certificates

Accepting a certificate:

- ▶ Select the certificate and click on the **Accept** button . . . depending on its type, the certificate is transferred to one of the **Server certificates / CA certificates** lists (even if it has already expired). If a server responds again with this certificate, this connection is accepted immediately.

Reject a certificate:

- ▶ Select the certificate and click on the **Reject** button . . . the certificate is transferred to the **Server certificates** list with the label **Rejected**. If a server responds again with this certificate, this connection is rejected immediately.

Checking information about a certificate

- ▶ Select the certificate and click on the **Details** button. . . a new web page appears, displaying the properties of the certificate.

Deleting a certificate from one of the lists

- ▶ Select the certificate and click on the **Remove** button. The certificate is deleted from the list immediately.

Import local certificate

You can make available further certificates to your phone system. The certificates must have been downloaded to your computer before.

- ▶ Click **Browse...** and select the local certificate file from your computer's file system ▶ click on **Upload** . . . the selected certificate file is loaded and, depending on its type, added to one of the certificate lists.

HTTP authentication

Define the credentials (user name and password) for HTTP authentication. The credentials are used for HTTP digest authentication of the provisioning client with the provisioning server.

HTTP digest username

- ▶ Enter the user name for HTTP authentication. Value: max. 74 characters

HTTP digest password

- ▶ Enter the password for HTTP authentication. Value: max. 74 characters

Date and time

By default, the system is configured so that the date and time are transferred from a time server on the internet. The page allows you to change the time servers, to set your time zone, and to make arrangements in case the internet time servers are not available.

It is only available in the Integrator user interface for the user role **admin**.

▶ **Settings** ▶ **System** ▶ **Date and time**

Time server

There are some common time servers preset in the field.

- ▶ Enter your preferred time server in the text field. Multiple time servers can be entered separated by commas. Value: max. 255 characters

Last sync time

Time of the last synchronisation.

Time Zone

- ▶ Select the time zone for your location from the option menu.

The time zone can be set for all DECT managers or for each individual DECT manager.

- ▶ If the time zone defined here should be used for all DECT managers, click on **Use on all DECT Managers**.

System time

Shows the time currently set for the phone system. It is updated every minute.

Fallback option

In case the internet time servers are not available you can set the time manually.

- ▶ Enter the time in the **System time** text field. Once you have started editing the automatic time update stops.

Act as Local Time Server

You can determine the internal time server to act as local time server for your network. If you have a time server available, you should not activate this function.

- ▶ Click on **Yes/No** to determine the internal time server to act/not to act as local time server.



Date and time are synchronised system-wide on all base stations and handsets. It can take up to one hour until the manually changed time is visible on every handset.

Synchronisation is carried out in the following cases:

- If a handset is registered to the telephone system.
- If a handset is switched off and switched back on again, or is outside the wireless range of the telephone system for more than 45 seconds and then comes back into range.
- Automatically every night at 4.00 am.

You can change the date and time on the handset. This setting only applies for that handset and will be overwritten when the next synchronisation takes place.

The date and time are displayed in the format set for that handset.

Firmware

Use this page to make adjustments in order to keep the phone system up-to-date via firmware updates.

It is only available in the Integrator user interface for the user role **admin**.

Regular updates to the firmware for the Integrator/DECT manager and base stations are provided by the operator or supplier on a configuration server. You can upload these updates onto the Integrator/DECT manager as required. If a firmware update is provided in the form of an update file, you can store it on your computer and download it from there.



The base stations' firmware is updated automatically by the DECT manager.

▶ **Settings** ▶ **System** ▶ **Firmware**

Current version

Shows the current firmware version of the Integrator/DECT manager on which you are logged in.

Backup available for previous version

You can downgrade the firmware by installing any older version. When installing a new firmware the system automatically creates a data backup for the recent firmware. If you later downgrade to this version the data backup will be installed on the system. This way you have a downgrade to previous firmware version and data settings.



Downgrade to any other version will reset the device to factory settings.

Selecting the firmware update file

▶ In the **URL to firmware file** text field specify the URL of the configuration server where the firmware is located

or

▶ Click **Browse...** and select the firmware file from your computer's file system.

Starting the firmware update

- At a specific date: ▶ Deselect the check box **Immediately** ▶ Enter the exact start time in the format: YYYY-MM-DD HH:mm
- Immediately: ▶ Select the check box next to **Immediately** (default) ... the firmware update is started when you click on the **Set** button.

Confirmed schedule

Shows **Immediately** or the date for the next planned firmware update.

- ▶ Click on **Set** to save the settings and to start the firmware update.

Once the update process starts, the system updates the DECT manager and all subordinate base stations automatically. No action is needed. The handsets lose their connection to the bases during the updating process. You can tell that the update has been successful when the handsets re-establish the connection to the base.

You can monitor in the base station list the current version of base station and the base stations and DECT managers offline most likely for firmware update.



The firmware update may take up a longer period. Do not disconnect the device from the local network during this time.



For test reasons (e.g. for testing a new release) it is possible to have a specific firmware version on a DECT manager subsystem which may be different from the rest of the system.

Handover between DECT manager systems is only possible if they have a matching protocol version.

A DECT manager with protocol version different to the system integrator cannot start its service because it is not interoperable to the system integrator. It just could do a software update to a matching software and protocol version.

DECT manager's firmware

You can schedule the firmware update for each DECT manager separately. The DECT managers are listed with the following information:

DM Name	Name of the DECT manager.
Current version	Firmware version currently installed on the DECT manager.
Confirmed schedule	Immediately or the date for the next planned firmware update.
URL to firmware file	URL of the configuration server on which the firmware is located.

Search for a specific DECT manager:

- ▶ Enter a search term in the **Search** field and select the search criterion from the **Search in** option menu.

Settings for a DECT manager:

- ▶ Click on  next to the DECT manager, whose firmware update you want to schedule ... **DM Name** and **Current version** is shown.

DECT manager firmware update

On this page you enter the planning data for a firmware update of the DECT Manager.

DM Name and **Current version** are shown.

URL to firmware file

► In the text field specify the URL of the configuration server where the firmware is located .

Planned schedule

At a specific date: ► Deselect the check box **Immediately** ► Enter the exact start time in the format: YYYY-MM-DD HH:mm

Immediately: ► Select the check box next to **Immediately** (default) . . . the firmware update is started when you click on the **Set** button.

Confirmed schedule

Shows **Immediately** or the date for the next planned firmware update.

► Click on **Set** to save the settings.

Save and restore

This page allows you to save and restore the system configuration.

It is available in the menu **Settings ► System ► Save and restore** for both the user role **admin** and **user**. The user is

Once you have configured the phone system and after making any changes to the configuration, particularly registering or de-registering handsets, you should save the latest settings in a file on the computer so that the current system can be restored quickly if problems occur.

If you change the settings accidentally or you need to reset the device due to a fault, you can reload the saved settings from the file on your computer to your telephone system.

The configuration file contains all system data including the DECT registration data of the handsets, but not the calls list on the handsets.

Saving configuration data

► Click on **Save settings** ► Select the location where the configuration file should be stored using the system file selection dialogue. Enter a name for the configuration file.

The default file name is

<MAC address of integrator><firmware version><date of export>_device-settings

Restoring configuration data

► Click on **Browse...** ► Select the previously saved configuration file from the file system of your computer. ► Click on **Upload** . . . the selected configuration file is loaded.



The secured configuration file can also be loaded onto a new device.

Prerequisites:

- The old device must no longer be in operation.
- The firmware version of the new device must correspond, at least, with the version of the device from which the data is saved, including the set patches.

Automatic backup

You can automatically back up your configuration to an SFTP server at regular intervals (SFTP = Secure File Transfer Protocol).

Enable automatic backup

- ▶ Select the check box next to **Enabled** ... the automatic backup of your configuration is activated according to the following settings when you click on the **Set** button.

Server

- ▶ Enter the address of the server to which the backup should be sent.



The URL must end with a slash (/), otherwise the SFTP upload will not start.

Example: `sftp://192.168.178.200/`

The system creates a backup file with the following name:

`<MAC address>_<software version>_YYYY_MM_DD_device-settings`

You can also enter the name of the file directly:

Example: `sftp://192.168.178.200/system_backup.cfg`

Server port

- ▶ Enter the port number, where the SFTP server expects to receive requests (default: 22).

Authentication name

- ▶ Specify the authentication name for the access to the SFTP server.

Authentication password

- ▶ Enter the password for the access to the SFTP server.

At a specific date: ▶ Deselect the check box **Immediately** ▶ Enter the exact start time in the format: YYYY-MM-DD HH:mm

Immediately: ▶ Select the check box next to **Immediately** (default) ... the firmware update is started when you click on the **Set** button.

Confirmed schedule

Shows **Immediately** or the date for the next planned firmware update.

Reboot and reset

This page allows you to reboot the device and to reset the system to factory settings. It is available in the Integrator user interface for both the user role **admin** and **user**.

▶ **Settings** ▶ **System** ▶ **Reboot and reset**

Manual reboot

▶ Click on **Reboot now** ▶ Confirm with **Yes** ... the reboot starts immediately.



On a system with embedded Integrator you can decide, if you want to reboot the local DECT manager too.

All existing connections managed by the affected base stations are terminated.

To reboot one single DECT manager: → p. 39

To reboot one single base station: → p. 47

Reset to factory settings

All configuration settings can be reset to the factory default. This will delete all settings, disconnect all connections, and terminate all calls!



When resetting to factory defaults all settings are lost. You can save your current configuration previously.

Factory reset can also be performed by using the device key (→ p. 25).

Defining the role

▶ From the option menu, select the role the device should have after the reset.

Base only

The device is used as base station.

All in one - dynamic IP

The roles Integrator + DECT manager + base station are active. The network configuration is set to dynamic IP.

All in one - static IP

The roles Integrator + DECT manager + base station are active. The network configuration is set to the following static IP settings:

IP address: 192.168.143.1

Subnet mask: 255.255.0.0

Gateway: 192.168.1.1

DECT-Manager+Base - dynamic IP

The roles base station + DECT manager are active. The network configuration is set to dynamic IP.

DECT-Manager+Base - keep IP

The roles base station + DECT manager are active. The network configuration is set to static IP.

Integrator only - dynamic IP

Only the Integrator role is active in the device. The network configuration is set to dynamic IP.

Integrator only - keep IP

Only the Integrator role is active in the device. The network configuration is set to static IP.



If you have installed the Integrator on a virtual machine

- only the **Integrator only** roles are available.
- you have to use the device key in order to reset the devices (→ p. 25).

Resetting the device

- ▶ Click on the **Reset to** button to reset the device to factory condition according to the selection made in **Reset to device** ... a confirmation dialogue is opened ▶ confirm with
 - Yes** The **Save and restore** page is opened allowing you to save the current configuration on your computer.
 - No** The reset procedure starts at once. The current configuration will be lost.
 - Cancel** The reset procedure is interrupted.

DECT settings

This page allows you to make settings for the DECT radio network.

It is only available in the Integrator user interface for the user role **admin**.

- ▶ **Settings** ▶ **System** ▶ **DECT settings**



Changing one of these settings requires a restart of the system. Ongoing calls will be cancelled.

ECO DECT

ECO DECT is an environment-friendly technology which reduces the power consumption and enables a variable reduction of transmission power.

DECT Radiation power

- ▶ Set the DECT radiation power to your needs:

Maximum range: The device range is set to maximum (default). This guarantees the best connection between the handset and the base stations. In idle status, the handset will not send radio signals. Only the base station will maintain contact with the handset via a low wireless signal. During a call, the transmission power automatically adapts to the distance between the base station and handset. The smaller the distance to the base, the lower the radiation.

Limited range: The radiation is reduced by up to 80 %. This will also reduce the range.

DECT security settings

DECT radio traffic between base stations and handsets is encrypted by default. The following options allow you to define the security settings in more detail.

DECT Encryption

- ▶ Activate/deactivate the option.

Activated: All calls are encrypted.

Deactivated: No calls are encrypted.

Enhanced Security - Early Encryption and Re-Keying

- ▶ Activate/deactivate the option.

Activated: The following messages are encrypted:

- CC (Call Control) messages in a call
- Data that may be sensitive at early stages of the signalling, e.g., dialling or CLIP information sending

The key used for encryption is changed during an ongoing call and thus improving the security of the call.

Deactivated: No CC messages or early data are encrypted.

Enhanced Security - Automatic release for non-encrypted calls

- ▶ Activate/deactivate the option.

Activated: If encryption is activated, it will be released in the case that a call is initiated by a device that is not supporting encryption.

Deactivated: Encryption is never released.

DECT radio settings

Due to different national regulations DECT units are required to use different frequency ranges to make them compatible with DECT systems in other areas. You can adapt the frequency range of the N870 IP PRO Multicell System to the requirements of your region.

DECT Radio band

- ▶ Select the radio frequency band used in your region.



Please select the DECT frequency band your system should operate according to your region. This is a system wide setting. Changing the setting will reboot the DECT radio part. Wrong setting may cause violation of legal regulations. In case of doubt, contact your Telecommunications Authority.

Diagnostics and troubleshooting

Status information

The status page offers important information on the system operation and the involved devices.

► **Status** ► **Overview**

The following information is provided.

Integrator status	<ul style="list-style-type: none"> • Device name • Device role • MAC address • IP address • DECT Frequency band • DECT PARI • Firmware version • Date and time • Last backup • Last backup transferred
DECT Managers	<ul style="list-style-type: none"> • Number of DECT Managers • Number of online DECT Managers • Number of DECT Managers with deviating Firmware Version <p>The symbol  indicates that the DECT manager is currently disconnected.</p>
Base stations	<p>Only with a multicell system</p> <ul style="list-style-type: none"> • Number of active base stations • Number of pending base stations • Number of online base stations • Number of offline base stations • Call limit for base station only
Mobile devices	<ul style="list-style-type: none"> • Number of registered mobile devices (reachable/all) • Number of mobile devices to register • Number of mobile devices with SIP registration (connected/all)



The list shows the items that are shown on the Integrator. Items marked by an asterisk (*) are also displayed on the status page of the DECT managers.

► Click on  **See also...** in the header line ... a list of all pages providing information or settings for diagnostic purposes is shown.

System backup

Besides **Last backup** date and time of the last backup is shown. As long as no backup has been created, **Never** is displayed instead.

Creating a new backup or restoring an existing backup file:

- ▶ Click on  **System** ▶ **Save and restore** ... the **Save and restore** page is opened.

Administration

For some entries you can directly jump to the associated Web configurator page.

- ▶ Click on the  button next to the corresponding entry in the table.

Base station events

This page displays counters for diagnostic purposes relating to various events that affect the base stations, e.g. active radio connections, handovers, unexpectedly terminated connections, etc.

It is available in the Integrator user interface for both the user role **admin** and **user**.

- ▶ **Status** ▶ **Statistics** ▶ **Base stations**

The following information is given:

DECT Manager Name of the DECT manager responsible for the base stations, time period in which the events have been collected, total number of missed and active calls of all managed base stations within the given time period.

Missed Calls: These are incoming calls that were successfully received by the DECT manager but did not reach the handset, e.g. due to insufficient coverage. This does not refer to missed calls by the user.

- ▶ Click on  next to the **DECT Manager** entry to display the clusters of the DECT manager.

Note: The symbol  next to the DECT manager name indicates that there could be a situation which requires attention.

Cluster Cluster number, summary of the collected events for all cluster base stations

- ▶ Click on  next to the **Cluster** entry to display the base stations of the cluster.

Base station Name of the base station



Some of the following information may be hidden. Use the **View** option menu to display the desired columns.

Properties

MAC address	MAC address of the base station
RPN	Radio Fixed Part Number, identifying the radio-entity
Sync RPN	RPN of the other base station the base station is synchronising with
Sync Level	Synchronisation level

Statistics

Conn	Number of established connections on DECT MAC layer. For example, through user actions: VoIP calls, accesses to an online phone book, Internet connections, etc. Or through system actions: Updating idle displays, date/time synchronisation, locating handsets for roaming, etc.
Ho setup	Number of incoming handovers
Ho release	Number of outgoing handovers
Call drops	Number of lost connections, i.e. interrupted calls
Async	How often the base station has lost on-air DECT synchronisation
Busy	How often the maximum number of possible connections of the module was achieved.
Conn. drops	How often the LAN connection to the base station was interrupted
Calls	Active calls
Calls-pk	Peak number of parallel calls
Sync swaps	Number of sync swaps, i.e. , how often the sync master has been changed due to a sync master crash.
q-idx-lt	LAN synchronisation quality > 90% LAN sync is functional. The remaining 10% evaluate the synchronisation quality. > 93% Good synchronisation quality.
o-thr-exc	PTP offset threshold exceeded counter If the PTP deviation > 500 ns, the counter is increased. The requirement for the network is that the PTP deviation is < 500 ns.
d-thr-exc	DLS offset threshold exceeded counter If the DLS deviation > 1000 ns, the counter is increased.

Actions

Displaying detailed statistical data on the base stations

- ▶ Click on the  button next to the name of a base station ... statistical evaluations about the base station synchronisation as well as further system information are output.

Exporting the information into a CSV file

For further processing of the statistic data you can export the data into a file with CSV (Comma separated Value) format.

- ▶ Click on **Export** ▶ Select the location where the file should be stored using the system file selection dialogue.

Displaying a graphical view of the cluster hierarchy

You can open a graphic that shows the cluster base stations, their relationship to the surrounding base stations, and the synchronisation hierarchy.

- Open the cluster tree of a DECT manager ► Select a cluster ► Click on **Show Cluster graph** ... the base stations of the selected cluster are shown in a graphic.

Presentation:

Connections		RSSI range 43 -100, good - excellent
		RSSI range 0 - 42, poor
		No data available
Base Status		Active and synchronised
		Other status (click on the symbol for more information)
		Deactivated
Synchronisation Mode		DECT, internal synchronisation
		DECT, external synchronisation
		LAN, internal synchronisation
		LAN, external synchronisation
		RFPI, external synchronisation

Example:

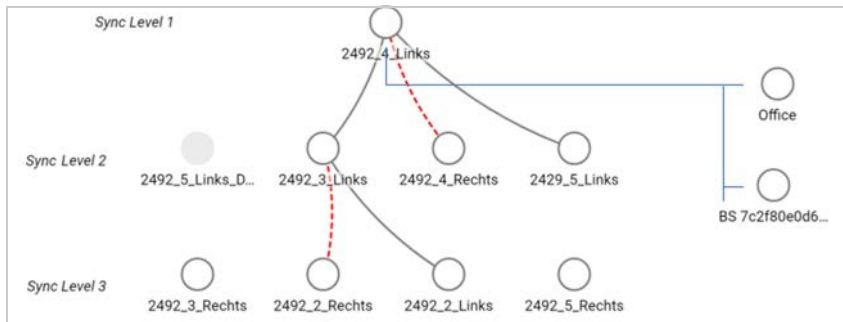

Saving the graph as a file: ► Click on **Save image** ► Select the location where the graphic file should be stored using the system file selection dialogue ... the graph is stored in PNG format.

Resetting the statistics

- Click on **Reset all** ... the counters in the table are reset to 0.

Filtering the list

- From the **Choose column** option menu select the column for which you want to set a filter. Note that columns may be hidden.

- ▶ In the text field enter the filter criteria ▶ Click on **Filter** ... only the entries matching the filter are shown.

For filtering the list according to specific counter values the following operators are possible:

< less than > more than = equal to
 <= less or equal >= more or equal

For the **MAC address** column only the following condition is allowed: = MAC address
 The MAC address must be in the following format: **aabbccddeeff** (without colons)

Deleting the filter: ▶ Click on **Clear**

Examples:

Only base stations with more than 20 busy situations should be displayed in the table. This could be achieved by the following filter settings.

Busy >20 Filter Clear

Only base stations with less than 5 call interruptions should be displayed in the table. This could be achieved by the following filter settings.

Call drops <5 Filter Clear

Displaying/hiding columns

- ▶ Click on the **View** option menu on the right ▶ Select the columns you want to be displayed in the table (👁 / 👁 = displayed/hidden).

Names of columns which cannot be hidden are greyed out.

Incidents

The page contains information on incidents concerning system operation.

It is available in the Integrator user interface for both the user role **admin** and **user**. The user is not allowed to delete entries.

- ▶ **Status** ▶ **Statistics** ▶ **Incidents**

Timestamp	Date and time of the incident
DECT Manager	DECT manager affected
Incident Type	e.g. Crash, Reboot, Reset
Severity	Degree of severity: Critical, High, Medium, Low, Info
Info	Detailed information, e.g., the component producing the incident

Actions

Downloading detailed information to a file

To get detailed information about the circumstances causing the error, you can download the incident information to a file. If required, you can pass it to the responsible service personnel.

- ▶ Mark the check box next to one or more incidents you want to download or next to **Timestamp**, if you want to download all incidents.

- ▶ Click on **Download** and select the desired file location for the log files in the file system ... for each selected incident a log file is created. All log files are taken into a tar file.

Deleting entries

- ▶ Mark the check box next to one or more incidents you want to delete or next to **Timestamp**, if you want to delete all incidents.
- ▶ Click on **Delete**.

Refreshing the list

- ▶ Click on **Refresh**, to update the information in the table.

System log and SNMP manager

The system report (SysLog) gathers information about selected processes performed by the phone system during operation and sends this to the configured SysLog server.

It is only available in the Integrator user interface for the user role **admin**.

- ▶ **Settings** ▶ **System** ▶ **System log**

Activate system log

- ▶ Mark/unmark the check box to activate/deactivate the logging function.

Server address

- ▶ Enter the IP address or the (fully qualified) DNS name of your Syslog server.
Value: max. 240 characters

Server port

- ▶ Enter the port number, where the Syslog server expects to receive requests.

Range: 1-65535; Default: 514

Transport protocol

- ▶ Select the transport protocol used for communication with the Syslog server.

Log level

- ▶ Mark/unmark the check boxes next to the log information that should be included/not included in the system log.

If you want to use the same system log server configuration for all DECT managers:

- ▶ Click on the **Use on all DECT Managers** button.



To set up the system log server individually for each DECT manager → p. 39.

SNMP statistics

The Simple Network Management Protocol (SNMP) is a common protocol used for monitoring and controlling of network devices. To gather management and statistic information concerning base station events to be processed by an SNMP manager you have to enter the address and authentication information according to the SNMP server configuration. SNMPv3 is supported, with authentication and privacy communication.

- ▶ Enter the IP address of the SNMP manager server in the **SNMP manager address** field and the port number used by the SNMP manager in the **SNMP manager port** field. Default: 162

To access the SNMP database authentication is necessary.

- ▶ Enter the **SNMP username** and the **SNMP password**.

The SNMP manager access data can be set for all DECT managers here or for each individual DECT manager (→ p. 40).

- ▶ If the access data defined here should be used for all DECT managers, click on **Use on all DECT Managers**.

Configuration

Default configuration

User name:	admin
Authentication protocol:	SHA
Password:	snmp-admin
Privacy protocol:	AES
Target for SNMP traps (SNMP manager IP address and port):	0.0.0.0:162

SNMP manager configuration example

Target host:	N870 IP PRO IP address
User name:	admin
Target port:	161
Security level:	Auth, Priv
Authentication protocol:	SHA
Authentication password:	snmp-admin
Privacy protocol:	AES128
Privacy password:	snmp-admin

SNMP commands (examples):

Obtaining MIB information starting from a specific MIB variable:

```
snmpwalk -v3 -l authPriv -u admin -a SHA -A snmp-admin -x AES -X snmp-admin "ipaddress" 1.3.6.1.4.1.32775.1.1.1
```

Obtaining next information in the MIB tree:

```
snmpgetnext -v3 -l authPriv -u admin -a SHA -A snmp-admin -x AES -X snmp-admin "ipaddress" 1.3.6.1.4.1.32775.1.1.1.1
```

Configuring SNMP-Traps:

```
trapsess -v 3 -u admin -l AuthPriv -a SHA -A snmp-admin -x AES -X snmp-admin "ipaddress"
```

Storing management information in MIB format

You can store management information for all base stations in MIB syntax.

- ▶ Click on **Download MIB** ▶ Select the location where the MIB file should be stored using the system file selection dialogue . . . the file with the MIB information is stored in TXT format.

Diagnostics

For diagnostic purposes you can create a dump with different contents. A dump may help software developers and system administrators to diagnose, identify and resolve problems that led to system failures.

- ▶ **Status** ▶ **Incidents** ▶ **Diagnostics**

A standard set of diagnostic info will be downloaded. Additionally you can add following options:

Core dump	Includes, if available, a core dump of a crashed application.
Ram dump	Includes, if available, a RAM dump of a crashed CSS (co-processor for DECT and media real-time processing). Core dump and CSS RAM dump can be used by service personnel for post-mortem debugging. Because the file size is several MBytes, not all data can be collected due to limited overall sysdump file size. Therefore, these options should be used carefully.
Last incident sysdump	Dump of the last incident. Contains only the system memory part that represents the last incident.
Save settings	If the option is activated, the diagnostic file contains the complete backup (default). A full backup makes problem resolution faster because all settings are included. The option can be deactivated if the client does not want to include such a backup for confidentiality reasons. In this case, the check mark must be removed each time a diagnostic file is created.

- ▶ Mark the check mark next to the dump type you want to include.
- ▶ Click on **Download** ▶ Select the location where the dump file should be stored using the system file selection dialogue. Enter a name for the dump file. The file is stored as tar archive. The default file name is
 <MAC address of integrator><firmware version><date of export>_diagnostics.tar

DECT measurements

For planning DECT sites or analysing specific network problems, you can collect DECT measurement data, save it in the N870 IP PRO and download it in CSV format for evaluation.

The measurement data of up to 20 sites can be stored.



You take DECT measurements with handsets that can be operated in measurement mode, for example, handsets included in the DECT Site Planning Kit (SPK) PRO. You could also use other handsets. However, the handsets in the measurement kit are calibrated. Only calibrated handsets provide calibrated measurement values.

Start measurement: ▶ Dial ▶ press the off-hook key ... the measurement starts immediately

Save measurement data: ▶ Press the **Log** display button ▶ enter the requested information about the location and position of the measuring devices ... the measurement data is saved in the system

On this page you can download measurement data stored on the system to your PC in CSV format.

▶ **Status** ▶ **Statistics** ▶ **DECT measurements**

DM Name

If you have carried out the measurement in a living system with several DECT managers:

- ▶ Select the DECT manager behind which you have carried out the measurement.

In case of an all-in-one system, you do not need to select the DECT manager.

Site

The names of the sites you entered when you started measuring processes on the handsets are listed. The number of the existing files for the site are shown below **Files**.

- ▶ Mark the check box next to the sites whose data you want to download.

Click on Download and select the desired file location in the file system.

For each measurement file of the selected sites a file is created in CSV format. The files of a site are taken into a tar file. All tar files are saved in another superordinate tar file.

- ▶ Click on **Delete** to remove the log files which are not longer needed from the system.

The oldest files are overwritten automatically when the maximum capacity of 20 sites is reached and no sites are deleted.



For detailed information on how to work with the DECT Site Planning Kit (SPK) PRO devices and how to evaluate the CSV files, refer to the corresponding user manual.

Migration

In order to migrate a small or medium N870 IP PRO Multicell System with one single DECT manager into a multi DECT manager installation, please perform the following steps:

- 1 Install the required licenses (→ p. 102)
- 2 Export the base station and handset configuration of your current installation
 - ▶ **Settings ▶ Base stations ▶ Administration** (→ p. 46)
 - ▶ **Settings ▶ Mobile devices ▶ Administration** (→ p. 74)
- 3 Import the integrator virtual machine (*.ova file) into your hypervisor (→ p. 21)
- 4 Define the device role for the devices that are defined to act as DECT manager in the future (→ p. 22).
- 5 Add DECT managers to the Integrator's administration
 - ▶ **Settings ▶ DECT Manager ▶ Administration** (→ p. 36)
- 6 Register the DECT managers on the Integrator
 - ▶ **Settings ▶ System ▶ Integrator Config** (→ p. 42)
- 7 Import the base station and handset configuration into the new configuration
 - ▶ **Settings ▶ Base stations ▶ Administration** (→ p. 46)
 - ▶ **Settings ▶ Mobile devices ▶ Administration** (→ p. 74)
- 8 Set up the new base station synchronisation hierarchy
 - ▶ **Settings ▶ Base stations ▶ Synchronisation** (→ p. 50)
- 9 If necessary, set up cross-cluster synchronisation via DECT manager synchronisation
 - ▶ **Settings ▶ DECT Manager ▶ Synchronisation** (→ p. 42)



During migration the base station synchronisation will be lost. Ongoing calls would be cancelled. Please ensure, that the phone system is not in use during the migration procedure.

The base station import does not contain the data of the local base station, because the local base station is physically bound to the new DECT manager.



The procedure only applies to the migration of a first DECT manager to a new multi DECT manager system. The handsets of a second system imported into the multi DECT manager system cannot import their old system PARI into the new multi DECT manager installation, thus these handset will be imported as **To register** and need to repeat on air DECT registration procedure.

Base station import of a second system does not need repetition of base station registration.

Using a handset connected to an N870 IP PRO base

The functions of your N870 IP PRO are available on the registered handsets. The functions of the telephone system are added to the handset menu. Handset-specific functions, e.g., local directory or organiser, are not described here. Information about this will be found in the relevant handset user guide. The availability of functions or their designations may differ on individual handsets.



For information about which Gigaset handsets support the complete functionality of the N870 IP PRO multicell system please refer to wiki.gigaset.com.

Making calls

You can make calls using any handset registered to your N870 IP PRO.

Prerequisite: You are located in the cell of at least one of the base stations registered to the telephone system.

The cells of the base stations together form the DECT wireless network of the telephone system. You can initiate or answer calls on a handset across the whole wireless network and change cells during a call (handover).

Prerequisite for handover: The base stations involved must be assigned to the same cluster and must be synchronised (→ p. 50).

Each handset is assigned a send and receive connection (→ p. 76).

If your N870 IP PRO is connected to a PBX that permits the formation of groups, VoIP connections can also be assigned to groups. In this case, you will also receive calls on your handset that have been sent to your group number.

The N870 IP PRO uses a VoIP PBX or the services of a VoIP provider for Internet telephony. The availability of some phone functions depends on whether they are supported by the PBX/provider and whether they have been enabled. If necessary, you can obtain a description of the services from the operator of your PBX.



Depending on the specifications of your PBX, you may need to dial an access code for calls outside the area covered by your VoIP PBX (→ p. 85).

Calling

▶ enter a number ▶ **briefly** press the Talk key

or

▶ Press and **hold** the Talk key ▶ enter a number



The connection is established using the SIP connection assigned to the handset (→ p. 76).



If you make a call to the fixed line network, you may also have to dial the area code for local calls (depending on the PABX/provider). This is not necessary if the area code is entered in the telephony configuration (→ p. 86).





Dialling from the redial list



The redial list contains the numbers last dialled with the handset.

- ▶ **Briefly** press the Talk key  ... the redial list is opened ▶  select an entry ▶ press the Talk key 

Dialling from the call list

The call lists contain the most recent accepted, outgoing and missed calls.

- ▶  ▶  **Call Lists** ▶ **OK** ▶  select a list ▶ **OK** ▶  select an entry ▶ press the Talk key 

 The **Missed Calls** list can also be opened by pressing the Message key .

Initiating ringback

If the number you have called is engaged or the participant called does not reply, you can arrange a ringback if your PBX/provider supports the CCBS and CCNR services.

CCBS (Completion of Call to busy Subscriber) Ringback if busy

CCNR (Completion of Calls on No Reply) Ringback if no answer

The service code for activating/deactivating CCBS, CCNR must be configured with the provider settings (→ p. 71).

Activating ringback:

- ▶ Enter the service code defined for the PBX/provider, e.g., *6

If you decide you do not want a ringback, you can switch the function off again:

- ▶ Enter the service code defined for the PBX/provider, e.g., #6

Accepting calls

Incoming calls for the connection assigned to your handset are signalled.

- ▶ Press the Talk key  to accept the call.

Switch off ringtone: ▶ **Silence** ... the call can be accepted as long as it is shown on the display

Reject a call: ▶ Press the End call key 

Information about the caller

The caller's phone number is displayed, if provided. If the caller's number is saved in the directory, the name is displayed.

Using a PBX call manager

In case a PBX call manager is used it is possible to define that incoming calls are accepted directly via headset or handsfree. This has to be configured for the handset via web configurator in the **Call manager** section (→ p. 79).



Group pickup

You can also accept incoming calls for the group.

Group pickup must be activated and the call number or SIP URI of the group must be entered. This has to be configured for the handset via web configurator in the **Group pick-up** section (→ p. 78)

Accepting/rejecting call waiting

A call waiting tone indicates a call during an external call. The number or the name of the caller is displayed if the phone number is transferred.

- Reject a call: ▶ **Options** ▶  **Reject** ▶ **OK**
- Accept a call: ▶ **Accept** ▶ Speak to the new caller. The previous call is placed on hold.
- End the call, resume the on-hold call: ▶ Press the End call key .

Conversation with three participants



Consultation calls

Make another external call during an external call. The first call is placed on hold.

- ▶ **Ext. Call** ▶  enter the number of the second participant ... the active call is placed on hold and the second participant is called

If the second participant does not answer: ▶ **End**

Ending a consultation call



- ▶ **Options** ▶  **End Active Call** ▶ **OK** ... the connection to the first caller is reactivated
- or
- ▶ Press the End call key  ... a recall to the first participant is initiated

Call swapping

Switching between two calls. The other call is placed on hold.

- ▶ During an external call, dial the number of a second participant (consultation call) or accept a waiting caller ... the display shows the numbers and/or names of both call participants
- ▶ Use the control key  to switch back and forth between participants

Ending a currently active call

- ▶ **Options** ▶  **End Active Call** ▶ **OK** ... the connection to the other caller is reactivated
- or
- ▶ Press the End call key  ... a recall to the first participant is initiated

Conference

Speaking to both participants at the same time.

- ▶ During an external call, dial the number of a second participant (consultation call) or accept a waiting caller ... then

Initiate conference call:

- ▶ **Confer.** ... all callers can hear one another and hold a conversation with one another

Return to call swapping:

- ▶ **End Conf.** ... you will be reconnected to the participant with whom the conference call was initiated



End call with both participants:

- ▶ Press the End call key 

Each of the participants can end their participation in the conference call by pressing the End call key  or hanging up.

Call transfer

Connecting an external call with a second external participant.

- ▶ Use the display key **Ext. Call** to establish an external consultation call ▶  enter the number of the second participant ... the active call is placed on hold ... the second participant is called ▶ press the End call key  (during a conversation or before the second participant has answered) ... the call is transferred



Call transfer options must be set correctly for the PBX/provider (→ p. 85).

Message indication

Notifications about accepted and missed calls, missed alarms and messages on the network mailbox are saved in messages list and can be displayed on the handset display.

Which messages are displayed on the handset is defined during handset configuration in the **Missed calls and alarms** section (→ p. 79).

Missed calls count

If the option is activated, the number of missed and accepted calls will be shown on the handset display in idle mode.

Message Waiting Indication (MWI)

For each message type (missed call, missed alarm, new message the network mailbox) the MWI option can be activated or deactivated via the web configurator.

If activated, the LED on the message key  flashes, in the case a **new message** arrives indicating missed calls, missed alarms or new messages on the network mailbox.

Using directories

The options are:

- The (local) directory for your handset (see handset user guide)
- Corporate directories provided by an LDAP server (→ p. 88)
- Miscellaneous online directories

The directories available are defined by the web configurator of the telephone system (→ p. 88).

Opening directories

Opening the corporate directory using the INT key

The INT key  (press left on control key) on the handsets opens a corporate directory, provided that this is set up via the web configurator using the **Corporate directory for INT key** option and can be accessed by the telephone system. The directory to be opened can be set for each handset (→ p. 77).

Opening directories using the directory key

The directory key  (press down on the control key) for the handset is normally set as follows:

- Press **briefly** to open the selection of available online directories.
- Press and **hold** to open the local directory

This assignment can be changed for each handset via the web configurator using the **Directory for direct access** option (→ p. 77). Direct access can be assigned to a specific online directory. In this case, open the local directory by pressing and holding the directory key.

The description below assumes the default assignment.

Opening directories via the menu

Depending on the handset used you can access all available directories also via the handset's menu:

Local directory

▶  ▶   **Contacts** ▶ OK ▶ **Directory** ▶ OK

List of all online directories set up on the telephone system

▶  ▶   **Contacts** ▶ OK ▶ **Online Directory** ▶ OK

The directories are displayed with the names specified in the web configurator.

Example for handling a corporate directory on the handset → p. 136



If handsets are connected to an N870 IP PRO, it is not possible to transfer entries from the local directory to another handset.

Using the network mailbox

The network mailbox accepts incoming calls made via the corresponding line (corresponding VoIP phone number).

Prerequisites

In order to allow the user to listen voice messages stored on a network mailbox the following settings are necessary:

On the VoIP PBX

- ▶ Set up a network mailbox for the VoIP connection that is to be assigned to the handset.

On the N870 IP PRO

- ▶ In the provider/PBX configuration activate the **SIP SUBSCRIBE for Net-AM MWI** option (→ p. 67). A subscription is established for the purpose of receiving notifications about new messages on the network mailbox.
- ▶ In the mobile devices configuration enter the **Call number or SIP name (URI)** and activate the network mailbox in the **Network mailbox configuration** section (→ p. 78).
- ▶ Optional: In the mobile devices configuration enable the **Flashing LED (MWI) for network mailbox** option (→ p. 79). New messages on the network mailbox are indicated by the MWI light on the Message key.

Playing back messages on the handset

- ▶ Press and hold  (if key 1 has been assigned to the network mailbox)

or

- ▶ Press the Message key  ▶  select the network mailbox ▶ **OK**

or

- ▶  ▶   **Answer Machine** ▶ **OK** ▶ **Play Messages** ▶ **OK** ▶  **Network Mailbox** ▶ **OK**

Listen to announcement out loud: ▶ Press the handsfree key 

LDAP directory – configuration example

To allow the entries of an LDAP directory to be displayed on the handsets, you will need to configure the phone's LDAP client. This involves the following:

- Setting up access to the LDAP server and database
- Specifying the attributes to be displayed (→ p. 135)
- Defining search criteria (filters) (→ p. 132)







Access to the LDAP server

To ensure that entries from the LDAP database are displayed on the phones, enter the access data via the web configurator.

▶ Settings ▶ Online directories ▶ Corporate

- ▶ Click on  next to the name of the LDAP directory you want to edit ... the LDAP configuration page is opened.

Access to the LDAP data server

Directory name 	<input style="width: 90%;" type="text" value="Our Directory"/>
	<input type="checkbox"/> Enable directory
Server address 	<input style="width: 90%;" type="text" value="ldap.ourserver.com"/>
Server port 	<input style="width: 90%;" type="text" value="389"/>
LDAP Search base (BaseDN) 	<input style="width: 90%;" type="text" value="cn=phonebook,dc=example,dc=com"/>
Username 	<input style="width: 90%;" type="text" value="cn=user_1,ou=users,dc=company,dc=com"/>
Password 	<input style="width: 90%;" type="password" value="••••••••"/>
Secure LDAP	<input style="width: 90%;" type="text" value="None"/>

- ▶ Enter a name for the directory in the **Directory name** field.
This is the name under which the directory will appear in the list of network directories on the telephones (→ p. 136).
- ▶ Select the option **Enable directory**, so that the directory will be displayed on the telephones.
- ▶ Enter the access data for the LDAP server

Server address	IP address or domain name of the LDAP server, e.g. 10.25.62.35 or ldap.example.com
Server port	Port on which the LDAP server expects queries from the clients. Normally the port number 389 is used (default).
Username / Password	Credentials for access to the LDAP server.



It is also possible to use individual access data for each handset (→ p. 78).

LDAP Search base (BaseDN)

The **LDAP Search base (BaseDN)** parameter specifies the starting point for the search in the LDAP directory tree. This starting point must be defined on the LDAP server and entered here for the LDAP client according to the server configuration. BaseDN is a special LDAP name which represents an object including its position in a hierarchical directory.

BaseDN is used to define which section of the hierarchical LDAP database is to be searched. Access to the entire directory can be enabled (e.g. to the corporate directory) or only to a subdirectory (e.g. the directory of a particular organisational unit).

BaseDN is created from series of RDNs (Relative Distinguished Names) found by walking up the directory information tree.

The BaseDN is specified as follows:

- The directory hierarchy is specified from left to right from the lowest level to the highest, e.g. object, organisational unit, organisation, domain.
- A hierarchical level has the following format: keyword=object, e.g. cn=PhoneBook.
- Hierarchical levels are separated by commas.
- It must be unique in the directory information tree.

The following objects are often used as hierarchical levels:

cn: common name
ou: organisational unit
o: organisation
c: country
dc: domain component

But other objects can also be used. For this parameter you require information on the structure of the LDAP server.

For the meaning of the objects, see section **Filters** → p. 132

Examples:

Starting point: Object PhoneBook, in the domain example.com

Definition: cn=PhoneBook,dc=example,dc=com

Starting point: Object PhoneBook in the subdirectory sales/support, in the domain example.sales.com.

Definition: cn=PhoneBook,o=support,ou=sales,dc=example,dc=sales,dc=com

Filters

With filters you define criteria by which the phone searches for certain objects in the LDAP database

- The name filter determines which attributes are used in the search for directory entries.
- The number filter specifies which attributes are used for the automatic search in the LDAP database when phone numbers are entered.
- Additional filters can be defined to enable detailed search.

Search in LDAP database

Enable list mode ?

Name filter ?	<code>((cn=%)(sn=%))</code>
Number filter ?	<code>((telephoneNumber=%)(mobile=%))</code>
Additional filter #1 name ?	City
Additional filter #1 value ?	<code>((l=%))</code>
Additional filter #2 name ?	Street
Additional filter #2 value ?	<code>((street=%))</code>
Display format ?	<code>%sn, %givenName</code>
Max. number of search results	50



The LDAP protocol offers various setting options for filters and search functions, e.g. wildcards, fixed character strings and further operators. For full details see the [RFC 4515](#).

Filter format

A filter consists of one or more criteria. A criterion defines the LDAP attribute in which the entered string is to be searched for, e.g. sn=%. The percent sign (%) is a placeholder for the user input.

Operators

Following operators can be used to create filters:

Operator	Meaning	Example
=	Equality	(attribute1=abc)
!=	Negation	!(attribute1=abc)
>=	Greater than	(attribute1 >=1000)
<=	Less than	(attribute1 <=1000)
~	Proximity (LDAP server dependent)	(attribute1 ~ = abc)
*	Wildcard	(attr1=ab*) or (attr1=*c) or (attr1=*b*)

Multiple criteria can be connected with logical AND (&) and/or OR operators (|). The logical operators "&" and "|" are placed in front of the criteria. The criterion must be placed in brackets and the whole expression must be bracketed again. AND and OR operations can also be combined.

Examples

AND operation: (&(givenName=*)(mail=*))

Searches for entries in which the first name **and** e-mail address begin with the characters entered by the user.

OR operation: (|(displayName=*)(sn=*))

Searches for entries in which the display name **or** surname begins with the characters entered by the user.

Combined operation: (|(&(displayName=*)(mail=*))(&(sn=*)(mail=*)))

Searches for entries in which the display name **and** e-mail address **or** the surname **and** e-mail address begin with the characters entered by the user.

Special characters

It is also possible to find entries containing special characters. If you want to compare these characters within an attribute string use backslash (\) and a 2-digit hex ASCII code as follows:

Special character	ASCII code
(\28
)	\29
<	\3c
>	\3e
/	\2f
\	\2a

Special character	ASCII code
=	\3d
&	\26
~	\7e
*	\2a
	\7c

Example

(givenName=James \28Jim\29)

will find any entry with givenName attribute's value equal to "James (Jim)"

Name filter

The name filter determines which attributes are used for the search in the LDAP database.

Examples:

- (displayName=%) The attribute **displayName** is used for the search.
 The percent sign (%) is replaced with the name or part of the name entered by the user.
 If you enter e.g. the character "A", the phone searches the LDAP database for all entries in which the attribute **displayName** begins with "A". If you then enter a "b", it searches for entries in which the **displayName** begins with "Ab".
- ((cn=%)(sn=%)) The attributes **cn** or **sn** are used for the search.
 If you enter e.g. the character "n", the phone searches the LDAP database for all entries in which the attribute **cn** or **sn** begins with "n". If you then enter an "o", it searches for entries in which the attribute **cn** or **sn** begins with "no".



LDAP does not distinguish between upper and lower case in the search request.

Number filter

The number filter defines which attributes are used in the automatic search for a directory entry. The automatic search is performed when a phone number is entered and in the case of an incoming call with calling line identification. If an entry is found for a phone number, the display shows the name instead of the number.

Entries are only found and displayed if the stored phone number matches the entered phone number exactly.

Examples:

- (homePhone=%) The attribute **homePhone** is used for the search.
 The percent sign (%) is replaced with the phone number entered by the user.
 If you enter the numbers "1234567" when dialling, the phone searches the LDAP database for entries with the private phone number "1234567".
- ((telephoneNumber=%)(mobile=%)(homePhone=%))
 The attributes **telephoneNumber**, **mobile** and **homePhone** are used for the search.
 If you enter the numbers "1234567" when dialling, the phone searches the LDAP database for entries with the private or mobile or work number "1234567".

Attributes

For a directory entry (an object), a series of attributes are defined in the LDAP database, e.g. surname, first name, phone number, address, company etc. The set of all attributes that can be stored for an entry is stored in the schema of the relevant LDAP server. To access attributes or define search filters, you must know the attributes and their names in the LDAP server. Most attribute names are standardised, but there can also be specific ones defined.

Which attributes can actually be displayed on a phone depends on

- which attributes are defined for an entry in the LDAP database,
- which attributes are set in the web configurator for display on the phone,
- which attributes can be displayed on the phone or handset.

Available attributes on handsets or phones

The following table shows the attributes that could be used for a directory entry on a handset or phone. Of course, the set of attributes that are actually shown depends on the specific handset used.

Attributes of a directory entry	Attribute name in the LDAP database
First name	givenName
Surname	sn, cn, displayName
Phone (home)	homePhone, telephoneNumber
Phone (office)	telephoneNumber
Phone (mobile)	mobile
E-mail	mail
Fax	facsimileTelephoneNumber
Company	company, o, ou
Street	street
City	l, postalAddress
Zip	postalCode
Country	friendlyCountryName, c
Additional attribute	can be freely defined

Specifying attributes for display on the phone

In the web configurator you specify which of the available attributes from the LDAP database are to be queried and displayed on the phone.

- ▶ For each attribute of a directory entry, select the appropriate attribute from the LDAP database. There are predefined settings at choice. Alternatively you can enter manually a different attribute defined in the LDAP database for this field.
- ▶ If an attribute is not to be displayed, select the option **none**.

In the **Additional attribute** field, you can enter an additional attribute that is available in the LDAP database and should be displayed. If the attribute is a number to be dialled, the option **Additional attribute can be dialled** must be checked.

The attributes **First name** and **Surname** will be used for the following functions:

- Display in the list of directory entries in the form **Surname, First name**
- Alphabetical sorting of the directory entries on the phone
- Name display of a caller or call participant

If the database query only produces one of the attribute values (e.g. because a contact is only stored with their first name), only this one will be displayed.

Display on the handsets

If one or more LDAP directories are set up in the web configurator, they will be available on the handsets with the following functions:

- Scroll through directory or search for directory entries,
- Display directory entries with detailed information (no edit or delete),
- Dial phone numbers directly from the directory,
- Add directory entries to the local directory.

When a phone number is entered or a call comes in, the directory is automatically searched for an entry that matches the phone number. If an entry is found, the name is displayed instead of the phone number.

To display the corporate directory on the telephone screen

The corporate directory is assigned to the INT key: ► press 



Depending on the settings for the handset in the web configurator (→ p. 77), you may also be able to access a corporate directory via the directory key .

Some handsets provide access also via the display menu. For details, see the user guide for your phone.

Entries in the directory

The following description shows an example for the display of an LDAP directory on a handset.

The menu shows all directories that have been set up and activated on the **Online directories** page in the web configurator. Each one appears with the name entered under **Directory name** in the web configurator (→ p. 130). In the example on the right, the LDAP directory is shown as **Our Directory**.

► use  to select the directory ► **OK**

The phone initiates a query to the LDAP server defined in the web configurator.

Directories	
Our Directory	
Directory 3	
Directory 4	
Directory 5	
Directory 6	
Back	OK

The LDAP directory is displayed according to the following rules:

- The search begins in the directory/subdirectory which is defined as the search base on the LDAP server and specified with the **LDAP Search base (BaseDN)** parameter in the web configurator (→ p. 131).
- The entries are listed in alphabetical order.
- The entries are displayed with **Surname** and **First name** if both attributes are available in the LDAP database. Otherwise only the surname or first name is displayed.

Our Directory	
Albert	
Bond	
Bond, James	
Bond, Paul	
Brown, Charly	
View	Options

Searching the directory

- ▶ Use  to scroll through the directory

or

- ▶ use  to enter a name (or the first few letters).

As soon as you press a key on the keypad, the telephone goes into search mode. You can enter up to 15 characters. All entries in the LDAP directory that match your input are displayed.



- ▶ Use  to delete the last character you entered.

The current search string is shown in the top line.

b	
Bond	
Bond, James	
Bond, Paul	
Brown, Charly	
< C	Options

br	
Brown, Charly	
< C	Options



Displaying a directory entry

- ▶ Use  to select the entry you want.
- ▶ Press the display key **View** or the navigation key .

or



- ▶ Press the display key **Options** ▶ **View**

The directory entry is displayed with its detailed information. Only attributes for which a value is stored are shown (→ p. 132).



- ▶ Use  to scroll through the entry.
- ▶ Press the End call key  or the **Back** display key to close the entry.

Brown, Charly	
Last Name:	Brown
First Name:	Charly
Phone (home):	1234567890
Back	▼

Dialling a number from the directory

- ▶ Use  to select the entry you want in the directory.
- ▶ Press the Talk key . If only one phone number is stored, it is dialled. If there are several phone numbers, they are displayed in a selection list.

or

- ▶ Use  to select the phone number you want in the detailed view of an entry: **Phone (home)**, **Phone (office)** or **Phone (mobile)**.
- ▶ Press the Talk key . The number is dialled.

Brown, Charly
Phone (office): 0987654321
Phone (mobile): 0908987876
Street: Avenue 12
Back

Appendix

Safety precautions



Read the safety precautions and the user guide before use.

Comprehensive user guides for all telephones and telephone systems as well as for accessories can be found online at wiki.gigaset.com. We thereby help to save paper while providing fast access to the complete up-to-date documentation at any time.



Do not use the devices in environments with a potential explosion hazard (e.g. paint shops).



The devices are not splashproof. For this reason do not install them in a damp environment such as bathrooms or shower rooms.



Remove faulty devices from use or have them repaired by our Service team, as these could interfere with other wireless services.



Using your telephone may affect nearby medical equipment. Be aware of the technical conditions in your particular environment, e.g. doctor's surgery. If you use a medical device (e.g. a pacemaker), please contact the device manufacturer. They will be able to advise you regarding the susceptibility of the device to external sources of high frequency energy (for the specifications of your Gigaset product see "Technical data").



For outdoor installations, please observe the Safety precautions of the installation environment, in particular with regard to lightning protection.

Customer Service & Help

Do you have any questions?

For quick help and information, please refer to this user guide or visit wiki.gigaset.com.

For online information and services concerning

- Products
- Documents
- Interop
- Firmware
- FAQ
- Support

please refer to wiki.gigaset.com.

For further information our Gigaset specialised reseller will be happy to help you related to your Gigaset product.

Authorisation

Voice over IP telephony is possible via the LAN interface (IEEE 802.3).

Depending on your telecommunication network interface, an additional router/switch could be necessary.

For further information please contact your Internet provider.

Country-specific requirements have been taken into consideration.

Gigaset Technologies GmbH hereby declares that the following radio equipment types are in compliance with Directive 2014/53/EU:

Gigaset N870 IP PRO / N870E IP PRO

The full text of the EU declaration of conformity is available at the following internet address:

www.gigaset.com/docs.

If this product will as well be imported into the UK:

Gigaset Technologies GmbH hereby declares that the following radio equipment types are in compliance with the Radio Equipment Regulations 2017:

Gigaset N870 IP PRO / N870E IP PRO

The full text of the UK declaration of conformity is available at the following internet address:

www.gigaset.com/docs.

This declaration could also be available in the "International Declarations of Conformity" or "European Declarations of Conformity" files.

Therefore please check all of these files.

The information on the compliance of our products with the UK Product Security and Telecommunications Infrastructure (PSTI) Act 2022 is available at the following internet address:

www.gigaset.com/PSTI

Environment

Environmental management system

Further information on environmentally friendly products and processes is available on the Internet at www.gigaset.com.



Gigaset Technologies GmbH is certified pursuant to the international standards ISO 14001 and ISO 9001.

ISO 14001 (Environment): Certified since September 2007 by TÜV SÜD Management Service GmbH.

ISO 9001 (Quality): Certified since 17/02/1994 by TÜV SÜD Management Service GmbH.

Disposal

Batteries should not be disposed of in general household waste. Observe the local waste disposal regulations, details of which can be obtained from your local authority.

All electrical and electronic products should be disposed of separately from the municipal waste stream via designated collection facilities appointed by the government or the local authorities.



This crossed-out wheeled bin symbol on the product means the product is covered by the European Directive 2012/19/EU.

UK: The Waste Electrical and Electronic Equipment Regulations 2013.

The correct disposal and separate collection of your old appliance will help prevent potential negative consequences for the environment and human health. It is a precondition for reuse and recycling of used electrical and electronic equipment.

For more detailed information about disposal of your old appliance, please contact your local council refuse centre or the original supplier of the product.

Care

Wipe the device with a **damp** cloth or an antistatic cloth. Do not use solvents or microfibre cloths.

Never use a dry cloth; this can cause static.

In rare cases, contact with chemical substances can cause changes to the device's exterior. Due to the wide variety of chemical products available on the market, it was not possible to test all substances.

Impairments in high-gloss finishes can be carefully removed using display polishes for mobile phones.

Contact with liquid

If the device comes into contact with liquid:

- 1 Unplug all cables from the device.
- 2 **Remove the batteries and leave the battery compartment open.**
- 3 Allow the liquid to drain from the device.
- 4 Pat all parts dry.
- 5 Place the device in a dry, warm place **for at least 72 hours (not in a microwave, oven etc.)** with the battery compartment open and the keypad facing down (if applicable).
- 6 **Do not switch on the device again until it is completely dry.**

When it has fully dried out, you will normally be able to use it again.

Technical data

Specifications

Power consumption

Operation as N870 IP PRO (DECT manager)	< 3.8 W
Operation as N870 IP PRO (base station)	< 3.8 W

General specifications

DECT Manager and base stations	
Power over Ethernet	PoE IEEE 802.3af < 3.8 W (Class 1)
LAN interface	RJ45 Ethernet, 10/100 Mbps Protection class IP20
Ambient conditions for operation	+5°C to +45°C indoors; 20% to 75% relative humidity
Protocols	IPv4, SNTP, DHCP, DNS, TCP, UDP, VLAN, HTTP, TLS, SIP, RTP, MWI, SDP, SRTP
Base stations	
DECT standard	DECT EN 300 175-x
Radio frequency range	1880–1900 MHz (Europe), 1910-1930 MHz (Latin America), 1910-1920 MHz (Brazil) 1880 MHz - 1895 MHz (South East Asia/Taiwan)
Transmission power	10 mW average power per channel, 250 mW pulse power
No. of channels	120 channels
Number of connections	10 simultaneous connections per base station (G.711), 8 simultaneous connections (G.729), 5 connections in wideband operation (G.722)
Range	Up to 300 m outdoors, up to 50 m indoors
Codec	G.711, G.722, G.729ab
Quality of Service	TOS, DiffServ

Accessories

Power adapter

You only need a power adapter if your devices are not powered by PoE (Power over Ethernet).

EU: Item number: C39280-Z4-C706

UK: Item number: C39280-Z4-C745

DECT Site Planning Kit (SPK) PRO (Site Planning Kit)

Equipment for planning and analysing your DECT multicell system. The case contains two calibrated Gigaset S650 H PRO handsets and one Gigaset N510 IP PRO base station, plus other useful accessories for measuring the signal quality and wireless coverage on your DECT network.

Item number: S30852-H2316-R101

Gigaset handsets

Upgrade your telephone system with extra handsets.

For information on handset functions in relation to Gigaset base stations, visit wiki.gigaset.com.

Index

- A**
- Access code 85
 - Access data for LDAP server 130
 - Activating base station 49
 - Active Directory server 92
 - Additional attributes 135
 - Address of LDAP server 130
 - Alarm licenses
 - assigning to handsets 80
 - Alarm server 98
 - AML (Alarming - Messaging - Location) 98
 - AML licenses 102
 - AND operator 133
 - Answer machine, playing back messages 129
 - Antennas
 - aligning 15
 - external 15
 - mounting 15
 - third-party 16
 - Application server 98
 - Area code 86
 - dialling 124
 - local 86
 - prefix 86
 - Attributes
 - defining for display 135
 - in LDAP database 135
 - Attributes in the LDAP database 91
 - Attributes, LDAP 135
 - c 92, 135
 - cn 91, 135
 - company 91, 135
 - displayName 91, 135
 - facsimileTelephoneNumber 91, 135
 - friendlyCountryName 92, 135
 - givenName 91, 135
 - homePhone 91, 135
 - l 92, 135
 - mail 91, 135
 - mobile 91, 135
 - o 91, 135
 - ou 91, 135
 - postalAddress 92, 135
 - postalCode 92, 135
 - sn 91, 135
 - street 92, 135
 - telephoneNumber 91, 135
 - user-defined 92, 135
- B**
- Audio quality 84
 - Authentication code for handset registration ... 76
 - Authorisation 140
 - Automatic backup 110
 - Automatic search 136
- B**
- Backup
 - automatic 110
 - Base station 7, 11
 - activating 49
 - administration 45
 - assign to a DECT manager 47
 - belonging cluster 62
 - connected 45
 - deleting 49
 - events 115
 - firmware 45
 - IP address type 48
 - LED display for operational states 24
 - LED display for synchronisation status 24
 - LED display, DECT traffic 24
 - MAC address 45
 - name 45
 - number 114
 - organising clusters 50
 - pending 47
 - rebooting 49
 - resetting 25
 - responsible DECT manager 45
 - sync level 62
 - synchronisation status 46, 62
 - Base stations
 - synchronised 62
 - synchronising 50
 - Blocking calls 41
 - BroadSoft XSI 87

- C**
- c, attribute 92
 - Call 124
 - Call blocking 41
 - Call list, dialling from 125
 - Call manger, accepting call directly 79
 - Call on hold settings 70
 - Call swapping, two external calls 126
 - Call transfer
 - external to external 127
 - Call transfer settings 85
 - Call waiting, external
 - accepting/rejecting 126
 - Calling 124
 - Care 142
 - Care of the device 142
 - Central phonebook 95
 - Certificate 84
 - web configurator 101
 - Certificates 104
 - CLI (Command Line Interface) 101
 - CLI access to the device configuration 101
 - Cluster 8, 62
 - configuring 50
 - graphical view 117
 - cn, attribute 91, 135
 - Codecs 69
 - Column
 - displaying/hiding 31, 118
 - Company directory 88
 - company, attribute 91, 135
 - Conference 127
 - Conference call
 - end 127
 - two external calls 127
 - Connected base stations 45
 - Connecting
 - power cable 21
 - Connecting the PC to the web configurator 27
 - Connecting to the LAN 20
 - Connection name 65
 - Consultation call 126
 - ending 126
 - Consumption of electricity, see
 - Power consumption
 - Contact with liquid 142
 - CSTA
 - access data 79
 - CSTA (Computer Supported
 - Telecommunications Applications) 72
 - CSV file, statistics 116
 - Customer Care 139
 - Customer Service 139
- D**
- Data protection notice 21
 - Database access 130
 - Date
 - setting 106
 - synchronisation 107
 - DECT
 - radiation 112
 - security 113
 - DECT base station 7, 11
 - DECT handset registration state 73
 - DECT integrator 6, 9
 - DECT level 62
 - DECT manager 6
 - adding 38
 - administration 36
 - capacity 37, 39
 - configuration 36
 - Firmware update 108
 - identifier 38
 - LED display DECT traffic 25
 - license master 37
 - number 114
 - reboot 39
 - redundancy 38, 41
 - registering at the Integrator 42
 - resetting 25
 - synchronisation 42
 - DECT manager operation, incidents 118
 - DECT measurement 122
 - DECT network 8
 - DECT radio settings 113
 - DECT Site Planning Kit ((SPK) PRO 122
 - DECT traffic
 - base station 24
 - DECT manager 25
 - Deployments 9
 - Device button 13
 - Device role 22
 - setting 22
 - DGUV support 98
 - DHCP server 33
 - Diagnostics 121
 - base stations 115
 - DECT manager incidents 118
 - Dialling
 - from the call list 125
 - from the redial list 125
 - DiffServ (Differentiated Services) 84
 - Directory
 - accessing 128
 - attributes 135
 - central phonebook 95
 - configuring 88
 - configuring handset access 77
 - corporate 88
 - displaying attributes 135
 - name 130

opening 136
 searching 137
 using 128
 XML format 94
 Directory entry
 attributes 91
 searching 137
 Display format, LDAP 91
 Display name, handset 73
 displayName, attribute 91, 135
 Disposal 141
 DLS (DECT over LAN Sync) 53
 DM zone 8
 DNS (Domain Name System) 34
 DNS redundancy method 67
 Domain name 130
 Domain part of the user address 65
 Download log files 118
 DSCP (Differentiated Services Codepoint) 52
 Dump 121
 Dynamic IP address
 base station 48

E
 ECO DECT 112
 Embedded integrator 11
 Emergency reset 26
 Environment 141
 External antennas 15

F
 facsimileTelephoneNumber, attribute 91, 135
 Factory settings 111
 Factory settings see Reset 23
 Failed registration retry timer 83
 Filter 132
 criteria 132
 format 132
 name 134
 number 134
 Filter, LDAP 89
 Firmware
 base station 45
 current version 107
 handset 74
 previous version 107
 update 107
 Firmware update
 LED display 24
 scheduled 108, 109, 110
 friendlyCountryName, attribute 92, 135

G
 G.711 70
 G.722 70
 enabling 84
 G.729A 70
 Gigaset DECT IP devices 5
 Gigaset N720 SPK PRO (Site Planning Kit)
 item number 144
 Gigaset N870 DECT IP Multicell System 6
 givenName, attribute 91, 135
 Global Catalog 92
 Graphical view of cluster hierarchy 117
 Group pick-up 78

H
 Handover 8
 Handset 7, 11
 belonging DECT manager 73
 DECT registration state 73
 de-registering 76
 directory assignment 77
 display name 73
 Firmware 74
 LDAP authentication 78
 menu 124
 MWI settings 79
 PIN for DECT registration 76
 provisioning 80
 registering 73, 75
 registration centre 81
 settings 76
 time-controlled registration 81
 type 74
 user name 73
 VoIP account registration data 77
 Handsets
 administration 73
 recommended 144
 registered 73
 Help 139
 Help function, web configurator 30
 homePhone, attribute 91, 135
 HTTP authentication 105

-
- I**
- Incidents 118
 - Installation
 - large 10
 - medium 10
 - small 9
 - Installing 19
 - Integrator 21
 - INT key 128
 - assigning directory 78
 - Integrator 6, 9
 - embedded 11
 - installation 21
 - status 114
 - virtual 11
 - IP Address
 - IPv4 33, 34, 49
 - IP address of LDAP server 130
 - IP address type 33
 - base station 48
 - IP configuration 33
 - IPUI (International Portable User Identity) 73
 - IPv4 (International Portable User Identity) 33
- J**
- Jitter 53
-
- L**
- l, attribute 92
 - LAN master 62
 - LAN master/slave 51
 - LAN port 20
 - LAN slot 13
 - LAN synchronisation 51
 - advantages 51
 - cluster selective 53
 - quality 116
 - Language, selecting for user interface 28
 - Language, user interface
 - change 29
 - Large installation 10
 - LDAP
 - Active Directory 92
 - display format 91
 - name filter 90
 - number filter 90
 - search base 89
 - secure 89
 - LDAP attributes 91, 135
 - LDAP authentication for handset 78
 - LDAP directory
 - configuring 88
 - name 88
 - server access data 88
 - LDAP filter 89
 - LDAP filter see also Filter
 - LDAP name 88
 - LDAP search base 131
 - LDAP server
 - address 130
 - domain name 130
 - IP address 130
 - port 130
 - user ID 130
 - LDAP server scheme 91
 - LDAP server, URL 88
 - LED displays 13
 - enabling/disabling for base stations 47
 - LEDs 24
 - License
 - enabling 102
 - for AML 102
 - grace period 103
 - master DECT manager 37, 103
 - Liquid 142
 - List
 - browse 31
 - filtering 30
 - sorting 30
 - Local area code 86
 - Local network 33
 - Local Time Server 106
 - Log file download 118
 - Log level 119
 - Logical operators see Operator
-
- M**
- MAC address, base station 45
 - mail, attribute 91, 135
 - Making calls 124
 - Measurement 122
 - Medical equipment 139
 - Medium installation 10
 - Menu overview
 - handsets 124
 - web configurator 31
 - MIB (Management Information Base) 40, 121
 - MIB format, statistics 40
 - Migration 123
 - Mobile devices
 - number 114
 - mobile, attribute 91, 135
 - Multicell system 5, 6
 - MWI settings 79

-
- N**
- N610 IP PRO 5
 - N670 IP PRO 5
 - N870 IP PRO 5
 - N870 IP PRO DECT Multicell System 6
 - N870E IP PRO 15
 - Name filter 132, 134
 - Name filter, LDAP 90
 - Navigation menu, show/hide 29
 - Network jitter 53
 - Network mailbox
 - entering number 129
 - playing back messages 129
 - Network MB, see Network mailbox
 - Network protocol 33
 - Non-SRTP calls, accepting 66
 - Number 91
 - Number filter 132, 134
 - Number filter, LDAP 90
-
- O**
- o, attribute 91
 - Online directory
 - LDAP 88
 - name 93
 - public 93
 - server URL 93
 - XSI 94
 - Online services 97
 - Open Source licenses 29
 - Operator
 - AND 133
 - OR 133
 - OR operator 133
 - ou, attribute 91, 135
 - Outbound proxy mode 67
 - Outbound proxy port 68
 - Outbound server address 68
 - Overload balancing 8
 - Overview 5
-
- P**
- Package content 18
 - Packet delay jitter 52
 - P-Asserted-Identity (PAI) 71
 - Password 130
 - Password, web configurator 28
 - changing 100
 - PBX access code 85
 - PBX profile 65
 - PCMA/ PCMU 70
 - Pending base stations 47
 - Phone number
 - dialling 138
 - Phone number in directory 135
 - Phone system 7
-
- Phonebook, central 95
 - backup 95
 - deleting 95
 - Place holder for user input 132
 - PoE (Power over Ethernet) 21
 - Port 130
 - postalAddress, attribute 92, 135
 - postalCode, attribute 92, 135
 - Power adapter
 - item number 144
 - Power cable slot 13
 - Power consumption 143
 - Power over Ethernet (PoE) 18
 - Power supply 21
 - P-Preferred-Identity (PPI) 71
 - PRACK (Provisional Response
 - Acknowledgement) 83
 - Priority of voice data 84
 - Profile 103
 - deleting 72
 - Profile, VoIP provider/PBX 65
 - Provider profile 65
 - Provisioning 103
 - Provisioning server 103
 - Proxy server
 - address 65
 - port 66
 - PTP (Precision Time Protocol) 53
 - PTP deviation 53
 - Public online directory 93
-
- Q**
- QoS (Quality of Service) 84
-
- R**
- Radiation power 112
 - Reboot
 - base station 49
 - LED display 24
 - manually 39
 - Redial list 125
 - Redundancy, DECT manager 38, 41
 - Registering a set of handsets 75
 - Registering
 - DECT managers at the
 - Integrator 42
 - Registering handsets 73, 75
 - time-controlled 81
 - Registering, with web configurator 28
 - Registration centre 81
 - Registration refresh time 66
 - Reset 111
 - emergency 26
 - to factory settings 25
 - via power procedure 25
 - Restore configuration 109
 - RFPI 43

- Ringback
 - switching function off if busy 125
 - when the number is busy 125
 - Ringtones, different 69
 - Roaming 8
 - RPN 45
 - RPN group 38
 - RTP (Realtime Transport Protocol) 84
 - RTP packetisation time (ptime) 70
-
- S**
- Safety precautions 139
 - Save configuration 109
 - SDP (Session Description Protocol) 70
 - Search base 131
 - Search mode 137
 - Search start point 131
 - Secure LDAP 89
 - Secure Real Time Protocol 66
 - Secure Shell (SSH) 101
 - SFTP (Secure File Transfer Protocol) 110
 - SIP port 83
 - SIP redundancy 67
 - SIP server port 67
 - SIP session timer 83
 - SIP timer T1 83
 - SISP 66
 - Site Planning Kit 12
 - Small installation 9
 - sn, attribute 91, 135
 - SNMP (Simple Network Management Protocol) 40, 120
 - SNMP configuration 120
 - SNMP manager 40, 120
 - Specifications 143
 - SRTP options 66
 - Standard gateway 34
 - Statistics
 - CSV file 116
 - download in MIB format 40
 - resetting 117
 - Status information 114
 - street, attribute 92, 135
 - Subnet mask 34
 - Subscription timer 83
 - Sync level 51, 62
 - Sync master redundancy 49
 - Sync master/slave 50
 - Sync reference 63
 - Sync slave 62
 - Synchronisation 50
 - best base of DM 42
 - cross-cluster 42
 - DECT 51
 - DECT manager 42
 - external with RFPI 43
 - over LAN 50, 51
 - over the air 50, 51
 - Synchronisation example
 - large, DECT-DECT-DECT 59
 - large, DECT-DECT-LAN 60
 - large, LAN-PTP domain-LAN 61
 - small/medium, DECT-LAN mixed 57
 - small/medium, pure DECT 54
 - small/medium, pure LAN 56
 - Synchronisation hierarchy 50
 - graphical view 117
 - Synchronisation planning 50
 - Synchronisation status
 - base station 24, 46, 62
 - SysLog 39, 119
 - System backup 115
 - System configuration 27
 - System report (SysLog) 39, 119
-
- T**
- tar file 122
 - Telephone system
 - overview 6
 - preparing to use 18
 - telephoneNumber, attribute 91, 135
 - Time
 - synchronisation 107
 - zone 106
 - Time server 106
 - Time zone
 - setting 41
 - Time, setting 106
 - Timer
 - failed registration retry 83
 - SIP session 83
 - SIP timer T1 83
 - subscription 83
 - Tone scheme 86
 - Transport protocol 66
-
- U**
- Update 107
 - User ID 130
 - User input, place holder 132
 - User name
 - handset 73
 - web configurator 28
-
- V**
- Virtual integrator 11
 - Virtual machine 21
 - Voice quality 84
 - VoIP provider, configure profile 65
 - VoIP settings 83

Issued by

Gigaset Technologies GmbH
Frankenstraße 2, D-46395 Bocholt

© Gigaset Technologies GmbH 2024

Subject to availability.

All rights reserved. Rights of modification reserved.

wiki.gigaset.com