

Gigaset

DECT Site Planning Kit (SPK) PRO

Table of Contents

Safety precautions	3
Introduction	5
First steps	5
Checking the package contents	5
Further recommended accessories	6
Before you begin	6
Setting up the measuring base station	7
Setting up the measuring handsets	10
Measurement	12
Advanced measurement mode	13
Display in simple metering mode	14
Evaluation of the measurement data	18
Download measurement data	18
Check measurement data	20
Administration and provisioning	21
N870 SPK PRO default settings	21
Changing the antenna mode	22
Creating/configuring a measuring base station from the scratch	22
Change the static IP address to your own preferred IP address	24
Appendix	25
Customer Service & Help	25
Authorisation	25
Data protection	25
Environment	26
Care	26
Contact with liquid	27
Technical details	27
Index	30

Safety precautions



Read the safety precautions and the user guide before use.

Comprehensive user guides for all telephones and telephone systems as well as for accessories can be found online at wiki.gigaset.com. We thereby help to save paper while providing fast access to the complete up-to-date documentation at any time.



The device cannot be used in the event of a power failure. In case of a power failure it is also **not** possible to make **emergency calls**.

Emergency numbers **cannot** be dialled if the **keypad/display lock** is activated!



Use only **rechargeable batteries** that correspond to the **specification** (see list of permitted batteries → wiki.gigaset.com). Never use a conventional (non-rechargeable) battery or other battery types as this could result in significant health risks and personal injury. Rechargeable batteries, which are noticeably damaged, must be replaced.



The handset must not be operated if the battery cover is open.

Ensure that the batteries can not be short-circuited by objects in the battery compartment.



Do not use the devices in environments with a potential explosion hazard (e.g. paint shops).



The base and charger are not splashproof. For this reason do not install them in a damp environment such as bathrooms or shower rooms.



Use only the power adapter indicated on the device.

Whilst charging, the power socket must be easily accessible.



Remove faulty devices from use or have them repaired by our Service team, as these could interfere with other wireless services.



Do not use the device if the display is cracked or broken. Broken glass or plastic can cause injury to hands and face. Send the device to our Service department to be repaired.



Keep small cells and batteries, which can be swallowed, out of the reach of children. Swallowing a battery can lead to burns, perforation of soft tissue and death. Severe burns can occur within 2 hours of swallowing. In the case of a swallowed cell or battery, seek medical care immediately.



To prevent loss of hearing, avoid listening at high volume over long periods of time.



Using your telephone may affect nearby medical equipment. Be aware of the technical conditions in your particular environment, e.g. doctor's surgery. If you use a medical device (e.g. a pacemaker), please contact the device manufacturer. They will be able to advise you regarding the susceptibility of the device to external sources of high frequency energy (for the specifications of your Gigaset product see "Technical data").



If a USB adapter cable is included in the delivery, only use a USB power supply (5 Volt) with USB-A connector. Damage can result by using other voltage sources (such as a PC with USB connector).

If a power adapter is included in the delivery, please use it.

Introduction

The DECT Site Planning Kit (SPK) PRO helps you to plan and install your DECT multi-cell system. It contains one measuring base station, two measuring handsets and further helpful accessories for exact determination of the DECT environmental conditions for the planned network, and is delivered in a case.

You can use the measuring devices in the case to determine the DECT wireless coverage at your location, establish how many base stations are required and their optimum location and find sources of interferences in the wireless network.

Additionally, you can use the equipment of the DECT Site Planning Kit (SPK) PRO to check the radio quality of problematic areas in an installed system and so eliminate network problems.



Detailed information on planning a multicell system and performing measurements to find the optimum positions for the base stations can be found online in the "N870 IP PRO - Site Planning and Measurement Guide" at wiki.gigaset.com.



First steps

Checking the package contents

The case contains the following subjects:

- | | |
|---|--|
| 1 x Gigaset DECT SPK PRO base station | 2 x R700H SPK PRO calibrated handset |
| 1 x Base station tripod mount | 2 x R700H charging cradle |
| 1 x Powerbank, 10000mAh | 2 x Power adapter, USB-A |
| 1 x Powerbank tripod mount | 2 x Charging cable, USB-A to charging cradle |
| 1 x Power adapter, 30W USB-C | 4 x rechargeable batteries (AAA) |
| 1 x Charging cable, USB-C to 12V Jack plug, 3 m | 2 x Headset |
| 1 x Charging cable, USB-C to 12V Jack plug, 0.5 m | 1 x Security leaflet |
| 1 x Charging cable, USB-C to USB-C | Cable ties |

Further recommended accessories

Tripod

To obtain an exact measurement, we recommend that you mount the measuring base station and the powerbank securely on a tripod.

The base station tripod mount is fitted with a thread connection for this purpose. A tripod mount is also supplied for the powerbank. This enables you to simulate the installation of a base station at every possible height and check the layout and range of the network.

The tripod should have a screw thread and be extendable to a height of 2.50 to 3.00m.



Before you begin

Please note that the measuring devices run on batteries that must be charged before you start taking measurements. Bear this in mind when planning your time.

The powerbank needs to be charged via the 30 W USB-C power adapter (fasted charging) or via the USB-A power adapter (slower charging). The charging time for fasted charging is approximately four hours.

You need two batteries for each measuring handset. These can be charged in the handset via the charger or in a standard battery charger. The charging time in the handset charger is approx. 8.5 hours.



Only use rechargeable batteries (→ p. 27) recommended by Gigaset Communications GmbH, i.e., never use conventional (non-rechargeable) batteries, otherwise serious health risks and personal injury cannot be ruled out. For example, the outer casing of the batteries could be damaged or the batteries could explode. The device could also malfunction or be damaged as a result of using batteries that are not of the recommended type.

Setting up the measuring base station

To ensure freedom of movement when measuring and not be dependent on being able to reach a power connection, operate the measuring base station via a powerbank. The case contains a powerbank and a USB-C charger device for this purpose.



If you reset the measuring base station to factory settings, you must restore its measuring functionality (→ p. 22).

Charging the powerbank

- ▶ Plug the 30W USB power adapter into a mains socket.
- ▶ Connect one end of the USB-C charging cable to the port of the USB power adapter [1].
- ▶ Insert the other end of the USB-C cable into the USB-C port of the powerbank [2].

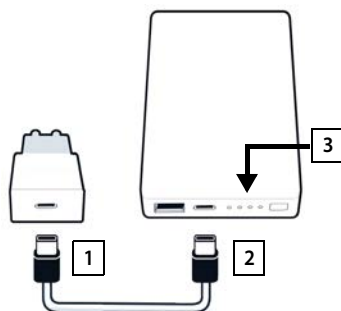

When all four LED power level indicators [3] become solid the powerbank is fully charged. You can now remove the USB cable from the powerbank.

Powerbank connectors and controls

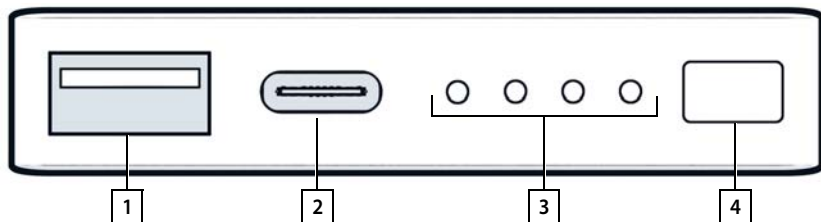

- | | | | |
|---|---------------------------|---|--------------------------------|
| 1 | USB-A port (Output) | 3 | Power level charging indicator |
| 2 | USB-C port (Input/Output) | 4 | Power level display button |

Power level charging indicator

In operation the charging indicator shows the power level, when it is charged it shows its charging status:

- ▶ Push the button **4** to activate/deactivate the power level charging indicator **3**.

In operation:	No LED solid:	0 %	○ ○ ○ ○	
	1 LED solid:	≤ 25 %	○ ○ ○ ●	
	2 LED solid:	≤ 50 %	○ ○ ● ●	
	3 LED solid:	≤ 75 %	○ ● ● ●	
	4 LED solid:	> 75 %	● ● ● ●	
When charging:	1 LED pulsing:	< 25 %		
	1 LED solid, 1 LED pulsing:	< 50 %		
	2 LED solid, 1 LED pulsing:	< 75 %		
	3 LED solid, 1 LED pulsing:	< 100 %		
	4 LED solid:	100 %		The powerbank stops charging.
	4 LED pulsing (5 sec):	Error		The powerbank turns itself off.

Mounting the base station

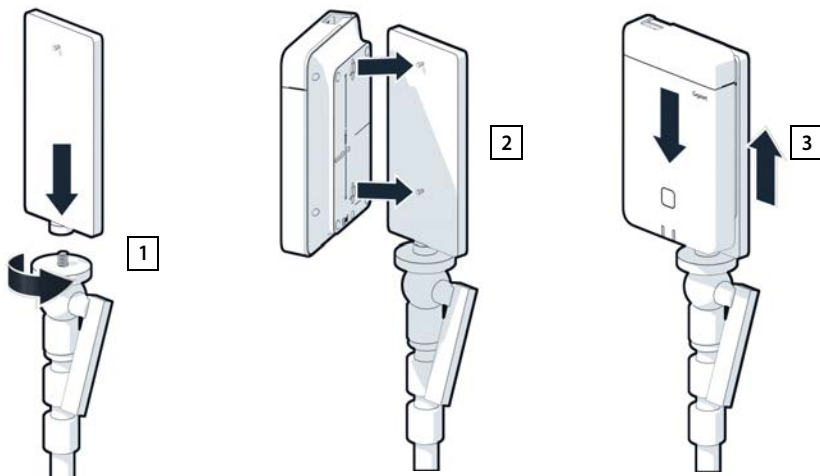

- ▶ Screw the tripod mount onto the tripod **1**.
- ▶ Slide the notches on the back of the base station over the hooks on the tripod mount **2**.
- ▶ Press the base station down until it clicks into place **3**.

Mounting the powerbank and connecting to the base station

- ▶ Attach the powerbank to the tripod using the powerbank tripod mount **1**.
- ▶ Open the flap at the top of the base station **2**.
- ▶ Connect the power connector on the base station **3** and the USB-C connector on the powerbank **4** with a charging cable.

You can use the short cable (0.5m) if the powerbank is mounted close to the base station or the long cable (3m) if needed.



You can power the base station for up to 20 hours continuously if the powerbank is fully charged.

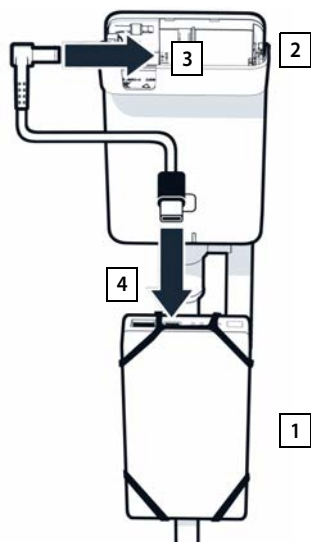

Alternative power supply

The measuring base station is supplied with power via the powerbank. Alternatively, you can also use one of the following power supplies:

Connecting to the 30W USB power adapter directly.

- ▶ Connect the power connector on the base station **1** to the 30W USB power adapter **2** via a power cable.
- ▶ Plug the power adapter into a mains socket **3**.

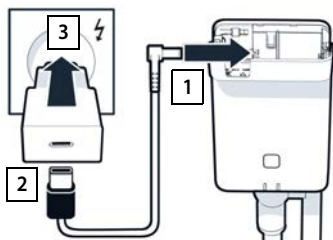

Connecting to a PoE switch (Power over Ethernet).

- ▶ Connect the LAN socket on the base station **1** to a socket on an Ethernet switch that provides PoE **2** via an Ethernet cable.

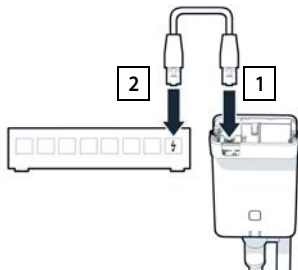

Setting up the measuring handsets

► Remove the measuring handsets and accessories from the case. For each handset there is:

- 1 One charging cradle
- 2 One USB-A to cradle cable
- 3 One USB-A power adapter
- 4 One battery cover
- 5 One belt clip
- 6 Four batteries (AAA), of which two are spares



The display and keypad are protected by plastic film; **please remove it.**

Inserting the batteries and closing the battery cover

- Insert the batteries (for correct +/- direction, see diagram).
- Line up the battery cover at the recesses with the inside of the casing.
- Then press the cover until it clicks into place.



To re-open the battery cover:

- Remove the belt clip (if attached).
- Use your fingernail to reach into the recess and pull the battery cover up.



Connecting the charging cradle

- ▶ Connect the flat plug of the power cable to the charging cradle **1**.
- ▶ Plug the USB connector of the power cable into the USB-A power adapter **2**.
- ▶ Connect the power adapter to the mains socket **3**.

To remove the plug from the charging cradle again:

- ▶ Press the release button **4** and pull out the plug.

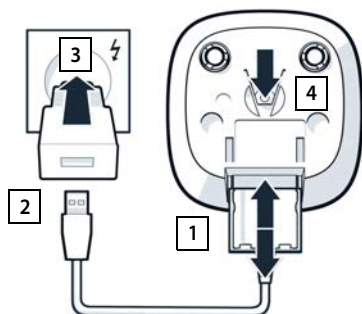

Initial charging of the batteries

- ▶ Charge the batteries fully prior to first use in the charging cradle or via a standard power adapter.

The batteries are fully charged when the power icon  disappears from the display.

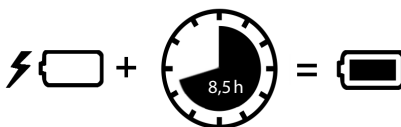

The battery may heat up during charging. This is not dangerous.

After a time, the charge capacity of the battery will decrease for technical reasons. Switch the handset off if you are not using it for a couple of days.

If you are not using the handset for a couple of weeks, switch it off and remove the batteries.

Connecting a headset to the handset

To assess the quality of the sound transmitted from the measuring station, you can connect headsets to the measuring handsets.

This also means that your hands are free to enter the locations determined in the plan and you can read the display during the measurement phase.

- ▶ Connect one of the headsets delivered to the headset connector on the left side of the measuring handset **1**.

If you do not use a headset, you should cover the headset connector with the rubber cover supplied.

- ▶ Insert the tab of the rubber cover into the opening **2** and press the rubber cover shut.

The headset volume corresponds to the setting for the receiver volume.

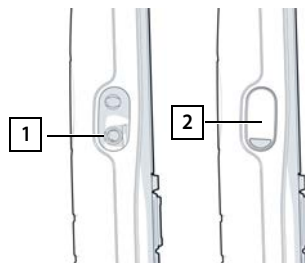

Measurement

You can use the Gigaset DECT SPK PRO as planning tool for a new network or for checking the radio coverage of a base station in an existing network.

There are two measurement procedures supported:

- **Advanced measurement mode**

This is the default procedure of the DECT Site Planning Kit (SPK) PRO and recommended for the measurement.

The measurement data are stored on the N870 SPK PRO base station and can be downloaded for evaluation to a computer via the web user interface or the Command Line Interface (CLI) in CSV format (→ p. 18).

- **Simple metering mode**

This is the procedure with the devices of the previous Site Planning Kit. It is disabled by default, but could be enabled, if required.

You will find detailed information on evaluating the measurement results in the "N870 IP PRO - Site Planning and Measurement Guide" at wiki.gigaset.com.



This section only describes the functions of the handsets relevant for measurements. For information on the standard functions of the Gigaset R700H SPK PRO handset, see the user guide for the device. See the product page at wiki.gigaset.com.

Handling the measuring handsets

The measuring handsets are already registered to the measuring base station on delivery.

Activating/deactivating the measuring handset

▶ Press and hold the  end key to activate/deactivate the handset.

The handset is activated automatically when it is connected to the power supply.

Switching the handsfree function on/off



You can also test the quality of the connection via the loudspeaker instead of via the headset.

▶ Press the  speaker key to switch between earpiece mode and speaker mode.

▶ When using the speaker mode, place the rubber cover supplied on the headset socket. This improves the quality in speaker mode.

Calls between the measuring handsets

You can check the voice quality by establishing a connection between the two measuring handsets. You need another person for this.

Calls between the handsets are possible using the  and  phone numbers.

The handsets are in idle status.

▶ Enter the phone number of the second handset (1 or 2) ▶ Accept the call on the other handset with the  talk key



You can also use other handsets for measurement. But only the handsets that are delivered in the measurement case are calibrated. Therefore the usage of normal handsets will not provide calibrated values.

Advanced measurement mode

To use this measurement procedure, the following requirements apply:

- System software of the N870 SPK PRO base station: at least version 2.53.0
- Software of the measuring handsets: at least 12.02

Starting the measurement procedure

► Dial ► press the  talk key ... the measurement starts immediately

The measurement values are displayed and updated every 960ms.

Calibrated handset:

A50	F	S	Rp	Fq%	dBm
009	8	02	03	100	-32
008	8	02	03	100	-31
007	8	02	03	100	-32
006	8	02	03	100	-32
005	8	02	03	100	-31
004	8	02	03	100	-31
Back	Log				

Not calibrated handset:

A50	F	S	Rp	Fq%	Rss
009	8	02	03	100	-32
008	8	02	03	100	-31
007	8	02	03	100	-32
006	8	02	03	100	-32
005	8	02	03	100	-31
004	8	02	03	100	-31
Back	Log				

Columns

First column

Counter of the measurement values obtained during the given call.

As measurement values are updated every 960ms, it roughly gives a time-stamp in the measurement call in seconds.

The column header shows the antenna mode currently set

Aopt: In call optimized antennas.

A50: 50% mix of two antennas for idle status quality measurement

Further information on antenna mode → p. 22

F Frequency

S Slot

Rp RPN (Radio Fixed Part Number). Identifies the base station on the air interface.

Fq% Frame quality in percent.

dBm RSSI value in dBm from calibrated measuring handset.

One dBm (decibel milliwatt) is the logarithmic value for the signal strength. It describes the strength of the transmission signal of a transmitted or received signal in relation to one milliwatt. This means that the results are more accurate than those of non-calibrated handsets.

- Rss** Rough RSSI indication from non-calibrated handset.
 RSSI (Received Signal Strength Indication) refers to the signal strength of a measuring point normalised in percent or relative.

Saving the measurement log on the base station

- ▶ Press the **Log** display key.
- ▶ Set information about location and site of the measurement.
 - HS Location:** Position of the handset at the start of the measurement process.
 - BS Location:** Position of the measuring base station.
 - Site:** Designation of the measurement location, e.g. a customer or a location.
- ▶ Press **OK** ... the measurement is started.

The measurement values are displayed. A new measured value is entered every 960 ms.

Log for	
HS Location:	
BS Location:	
Site:	
Back	OK

Measurement will stop automatically after 60 seconds.

- Stopping manually: ▶ Press the **Stop** display key
- Saving the values: ▶ Press the **Save** display key ... the measurement values are saved on the base station
- Discarding the values: ▶ Press the **Cancel** display key

Display in simple metering mode







In the previous Gigaset Site Planning Kit this metering mode was used to show the current status values of the connection to the base station. In the DECT Site Planning Kit (SPK) PRO this metering mode has been replaced by the advanced measurement mode. The simple metering mode is disabled. For calibrated handsets it is possible to enable the metering mode.



Use this mode if you want to collect current measurement data regarding the connection to a specific base station during operation.

The measurement data is not stored on the base station.



Activating/deactivating simple metering mode

- ▶ Press and **hold** the off key  ... the handset is switched off.
- ▶ Press and **hold** the ,  and  keys at the same time ▶ press and hold the talk key  ... the handset is now in service mode.
- ▶ Enter the five-digit service PIN. On delivery this is **76200** ... the service menu is opened.
- ▶  Select the **Metering Mode** entry.
- ▶ Press the display key **Change** ... the metering mode is activated.

Service	
Metering Mode	<input checked="" type="checkbox"/>
Measure Time	<input type="checkbox"/>
Working Time	<input type="checkbox"/>
Apprv. Narr.Band	<input type="checkbox"/>
Apprv. Wide Band	<input type="checkbox"/>
Back	Change

Changing the settings for metering mode

Once you have activated the simple metering mode, the **RSSI measurement** menu is opened. Here you can change some settings for measurement procedures.

- ▶ Use the  navigation key to switch between the setting options.
- ▶ Use the  navigation key to select the desired value.
- ▶ Press the **Start** display key to activate your metering settings.
- ▶ Press the **Back** display key to exit the service menu.

RSSI measurement	
Metering Mode:	
< dBm	>
Metering range:	
06	
No Intercell HO:	
Off	
Back	Start

The handset is deactivated. When you reactivate it, it is in metering mode with the selected settings.

Metering Mode

Defines the unit the measurement result is shown.

dBm Per default, the signal strength (RSSI value) is shown on the display in **dBm** (recommended mode).

% The signal strength measured is displayed as a percentage of the maximum possible RSSI.

SEN Not relevant.

Metering range

Defines the time intervals at which measurements are taken.

Value range: 06 – 16 (1.0 s – 2.5 s); Recommended value: 16

No Intercell HO

Allows you to measure a single base station in an installed multicell system during an active call.

- On** The measuring handset will not switch to another base station in the multicell system, even if this provides a stronger signal (no handover).
- Off** The handset does not switch to another base station in the multicell system, if this provides a stronger signal (default).

Scenario: The handset moves from **A** to **B**.

No Intercell HO = On

During the call, the handset remains connected to the base station RPN 02.

No Intercell HO = Off (default setting)

During the call, the handset will switch to the stronger base station RPN 03.

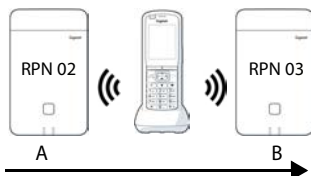

No Roaming

Allows you to measure a single base station in an installed multicell system when the handset is in idle state.

- On** The measuring handset will not switch to another base station in the multicell system, if another base station provides a stronger signal.
- Off** The handset will switch to another base station in the multicell system, if it provides a stronger signal (default).

Scenario: The handset moves from **A** to **B**.

No Roaming = On

In idle mode, the handset remains connected to the base station RPN 02.

No Roaming = Off (default setting)

In idle mode, the handset will switch to the stronger base station RPN 03.

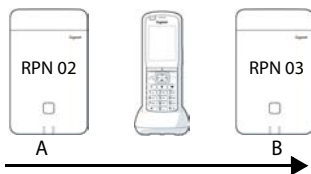

You should not make changes to other settings in the service menu.

Displaying measurement results in simple metering mode

In simple metering mode, the display shows the current status values of the connection to the base station. The values are updated at brief intervals. You can change this measuring interval (→ p. 15).

Display in idle mode

The display shows the following information in idle status:

Values for determining the connection quality:

RSSI value Base station signal reception strength with the best reception in **dBm**.

Acceptable value: -20 to -70 dBm.

Units for signal strength → p. 15.

Fr. quality Frame quality. Percentage rate of the packages received without error in the last measuring interval.

Acceptable value: 95 – 100%

Also the following information is displayed:

Frequency Carrier frequency of the signal received.
Value range: 0 – 9.

Slot pair Duplex **Slot pair** used (0 – 11)
Time slot for the reception channel on which the measurement was performed.

Note: During the transition in the connection status, value 15 is occasionally displayed.

RPN **RPN** (Radio Fixed Part Number)
ID of the base station to which the handset is connected. The value is displayed in hexadecimal format.

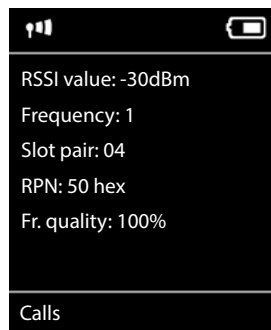

Display not in idle mode

If the display is not in idle status, it shows the measurement data at the top edge.

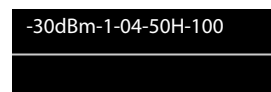

Evaluation of the measurement data

Using the advanced measurement procedure the measurement data are stored on the measuring base station. For evaluation they can be downloaded and stored in CSV format on your computer.

Download measurement data

The measurement files can be downloaded via:

- The Web user interface of the base station
- The CLI (Command Line Interface)

Download via the Web user interface



For detailed information on working with the Web interface of the N870 SPK PRO base station please refer to the "N870 IP PRO - Installation, configuration and operation" guide.

- ▶ Open the Web user interface of the N870 SPK PRO base station
- ▶ Go to **Status** ▶ **Statistics** ▶ **DECT measurements**

The screenshot shows the Gigaset web interface. The top navigation bar has 'SETTINGS' and 'STATUS'. The left sidebar is expanded to 'Statistics', with sub-items: 'Base stations', 'Incidents', 'Diagnostics', and 'DECT measurements'. The main content area is titled 'DECT coverage measurement by handset'. It features a 'DM Name' dropdown menu currently set to 'local'. Below this is a section 'Measured sites and related log files' containing a table:

Site	Files
<input checked="" type="checkbox"/> Bocholt	2

At the bottom of the table area are 'Download' and 'Delete' buttons. There is also an 'Auto-hide menu' checkbox in the sidebar.

DM Name

If you have carried out the measurement in a living system with several DECT managers:

- ▶ Select the DECT manager behind which you have carried out the measurement.

In case of an all-in-one system, you do not need to select the DECT manager.



The N870 SPK PRO base station is an all-in-one system, which means that it contains a local DECT manager.

Site

The names of the sites you entered when you started measuring processes on the handsets are listed. The number of the existing files for the site are shown below **Files**.

- ▶ Mark the check box next to the sites whose data you want to download.
- ▶ Click on **Download** and select the desired file location in the file system.

For each measurement file of the selected sites a file is created in CSV format. The files of a site are taken into a tar file. All tar files are saved in another superordinate tar file.

Download via Command Line Interface (CLI)

You can download the measurement data of a base station via the **measure-dump** CLI command.

Syntax

```
cli@base-dm-7c2f80cfe206:~$ measure-dump -h
```

```
Usage: measure-dump [<options>]
```

```
-h          Show this help
```

```
-l          Lists all sites of which measurement logs are available
```

```
-r <site>   Remove the generated measure-dump.tar file (/tmp/pub/measure-dump.tar)
            and the measurement logs of given site (dflt: all sites)
```

```
<site>     Dump measurement of given site, if option is not provided, all sites will be
            dumped
```

Note: Don't forget to remove your measurement data, if download was successful.

Otherwise you might leave your data on the measurement device.

Example: Collecting the measurement data for all sites

```
cli@base-dm-7c2f80cfe206:~$ measure-dump
```

The files can be download via:

- WinSCP
- a Web browser, example: <https://<IP address>/pub/measure-dump.tar>
- other SSH tools ...



Detailed information on the **measure-dump** CLI procedure can be found at wiki.gigaset.com.

Check measurement data

You need to unzip the tar file two times to have the readable CSV files with the measurement data.

Example

Downloaded file: **base-dm-int-589ec62904f3-measure-dump.tar**

```
unzip base-dm-int-589ec62904f3-measure-dump.tar
base-dm-int-589ec62904f3-measure-dump/base-dm-int-589ec62904f3-measure-dump
unzip base-dm-int-589ec62904f3-measure-dump
measurements/<sitename>/
<sitename>_<hs location>_dps.csv
<sitename>_<bs location>_<hs location>_measurement.csv
```

CSV files

There are two CSV files for each measurement:

- ... **_measurement.csv** contains the measurement data of a connection between the handset and the measuring base station.
- ... **_dps.csv** contains measurement data about all bases seen by the handset. This feature can be used to measure in running installations.

measurement.csv

antenna	sample#	rpn	base-location	handset-location	calibrated	rssidBm	rss%	frequency	timeslot	frame-quality
Aopt	57	2	Office	A3	1	-30	97	4	8	100
Aopt	58	2	Office	A3	1	-30	97	4	8	100
Aopt	59	2	Office	A3	1	-30	97	4	8	100
Aopt	60	2	Office	A3	1	-35	94	4	8	100
Aopt	61	2	Office	A3	1	-35	94	4	8	100
Aopt	62	2	Office	A3	1	-36	91	4	8	100
Aopt	63	2	Office	A3	1	-40	86	4	8	100
Aopt	64	2	Office	A3	1	-40	86	4	8	100
Aopt	65	2	Office	A3	1	-38	89	4	8	100
Aopt	66	2	Office	A3	1	-36	91	4	8	100
Aopt	67	2	Office	A3	1	-36	91	4	8	100
Aopt	68	2	Office	A3	1	-36	91	4	8	100
Aopt	69	2	Office	A3	1	-35	94	4	8	100
Aopt	70	2	Office	A3	1	-35	94	4	8	100

antenna	The selected antenna mode (→ p. 22)
sample#	Sequence number of the measurement sample
rpn	RPN (Radio Fixed Part Number) of the DECT measuring base station
base-location	Location of the base station as entered via the handset when starting the measurement log
handset-location	Location of the handset as entered via the handset when starting the measurement log
calibrated	1 = Calibrated handset / 0 = Non calibrated handset
rssidBm	RSSI value in dBm
rss%	RSSI value in %
frequency	DECT frequency

timeslot DECT timeslot
frame-quality DECT frame quality 0 - 100%

dps.csv

The **dps.csv** file contains information about all base stations seen by the handset. This feature can be used to measure in running installations.

hs-position	fpn	rpn	rssl
A3		15	2 57
A3		15	3 51



hs-position The handset measurement location entered via the handset when starting the measurement log
fpn FPN (Fixed Part Number) of the measuring base
rpn RPN (Radio Fixed Part Number) of the measuring base
rssl RSSI value in %

Administration and provisioning

N870 SPK PRO default settings

The N870 SPK PRO has the following default settings:

IP address: Static 192.168.143.1
 You can change the IP address (→ p. 24). But it must be static, otherwise you cannot put the device into operation without a LAN connection.

Username/password: **admin/admin**
 You must change the password after the first login.

Number Handset 1: 1
Number Handset 2: 2
DECT Radio frequency band: 1880 MHz - 1900 MHz (Europe)

Changing the antenna mode

The following antenna mode options are supported:

A50 50% mix of the two antennas for idle status quality measurement
Both antennas are used 50% of the time. This mode is recommended for checking the quality, as it behaves in the same way

- as handset in idle status,
- as the base stations synchronizing via DECT.

Measurement done in this mode can provide a lower signal quality than using the **Aopt** mode but for a DECT measurement it is the better method.

Therefore this is the default setting for Gigaset DECT SPK PRO.

Aopt In call optimized antenna

During an active call, the antenna optimization (diversity) is used. Where automatically the best antenna is selected by the system to offer the best speech quality.

This is the default setting for regular base stations of the Gigaset DECT PRO product family, to select best antenna in call state.

The antenna mode can be changed via provisioning.

Antenna mode provisioning template:

```
<?xml version="1.0" encoding="UTF-8"?>
<provisioning version="1.1" productID="e2">
  <nvm>
    <!--
    0x00 //current best antenna-diversity algorithm
    0x13 //Dummy-Bearer Algorithm ~50% per antenna
    -->
    <param name="DmGlobal.0.DECTAntennaMode" value="0x00" />
  </nvm>
</provisioning>
```

- ▶ Load the provisioning template to the system (→ p. 24)

Creating/configuring a measuring base station from the scratch

A provisioning template is made available

- to create your own measuring base station using a standard N870/N870(E) IP PRO device. The system firmware must be 2.53.0 or higher.
- to restore the measuring function of a N870 SPK PRO base station, if you have reset it to factory settings.



You can download the provisioning template from wiki.gigaset.com.

► Download the **SPK_provisioning_template.xml** file

```
<?xml version="1.0" encoding="UTF-8"?>
<provisioning version="1.1" productID="e2">
  <nvm>
    <param name="DmGlobal.0.SystemRegDomain" value="EUR" />
    <oper name="set_uci">
      <!-- Change network to Static IP -->
      <param name="network.lan.proto" value="static" />
      <param name="network.lan.ipaddr" value="192.168.143.1" />
      <param name="network.lan.netmask" value="255.255.0.0" />
    </oper>
    <!-- Provider settings to make internal calls between the DECT handsets -->
    <param name="SipProvider.0.Name" value="Localhost"/>
    <param name="SipProvider.0.Domain" value="Localhost"/>
    <param name="SipProvider.0.ProxyServerAddress" value="127.0.0.1"/>
    <param name="SipProvider.0.TransportProtocol" value="2"/>
    <param name="SipProvider.0.CallsWhileUnregistered" value="y"/>
    <!-- Handset 1 with number 1 -->
    <oper name="add_hs" value="00000">
      <param name="hs.RegStatus" value="ToReg"/>
    </oper>
    <param name="SipAccount.00000.AuthName" value="1" />
    <param name="SipAccount.00000.AuthPassword" value="GigasetSPK1" />
    <param name="SipAccount.00000.UserName" value="1" />
    <param name="SipAccount.00000.DisplayName" value="1" />
    <param name="SipAccount.00000.ProviderId" value="0" />
    <!-- Handset 2 with number 2 -->
    <oper name="add_hs" value="00001">
      <param name="hs.RegStatus" value="ToReg"/>
    </oper>
    <param name="SipAccount.00001.AuthName" value="2" />
    <param name="SipAccount.00001.AuthPassword" value="GigasetSPK2" />
    <param name="SipAccount.00001.UserName" value="2" />
    <param name="SipAccount.00001.DisplayName" value="2" />
    <param name="SipAccount.00001.ProviderId" value="0" />
    <!-- Enable that device starts with no LAN connected -->
    <oper name="set_uci">
      <param name="network.lan.force_link" value="1"/>
      <param name="network.lan6.ifname" value="lo"/>
    </oper>
    <!-- Open registration window for 3600 seconds -->
    <oper name="update_dm" value="local" >
      <param name="RegStart" value="1" />
      <param name="RegDuration" value="3600" />
    </oper>
  </nvm>
</provisioning>
```

- ▶ Change the antenna mode to **A50** (50% per antenna) by adding the following lines to the provisioning template:

```
<!--
0x00 //current best antenna-diversity algorithm
0x13 //Dummy-Bearer Algorithm ~50% per antenna
-->
<param name="DmGlobal.0.DECTAntennaMode" value="0x13" />
```



Do not change parameters without a reason and pay attention to the syntax. Errors in the provisioning file can render the system unusable.

Uploading the provisioning file to the system

- ▶ Open the Web user interface of the device you want to use for measuring or to restore.
- ▶ Go to **Settings – System – Provisioning and configuration**
- ▶ Click on **Browse...** ▶ Select the provisioning file from your file system ▶ Click on **Upload**
- ▶ Click on **Start auto configuration**

The system will shut down and restart with the new provisioning file. The system is ready for operation when at the base station the left LED lights blue and the right LED lights green.

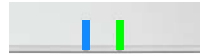

- ▶ Register the two calibrated measuring handsets. PIN = 0000.

Go to **Settings – System – Mobile devices**

Check whether calls between handsets are possible:

- ▶ Switch on the base without connecting to the LAN ▶ Make a call from one handset to the other.

Handset 1: number is 1, Handset 2: number is 2

Change the static IP address to your own preferred IP address

If you want to use your own IP address, change the default IP address (192.168.143.1) in the provisioning template before uploading the provisioning file in your system.



If you change the static IP address via the web user interface, the setting to start the device without LAN is deactivated. Therefore you need to change it via the provisioning template.

Changing the device network settings to dynamic IP would also interrupt the measurement functionality of the device.

- ▶ Change the IP address in the provisioning file to your own preference

```
<param name="network.lan.proto" value="static" />
<param name="network.lan.ipaddr" value="192.168.143.1" /> ←
<param name="network.lan.netmask" value="255.255.0.0" />
```

Appendix

Customer Service & Help

Do you have any questions?

For quick help and information, please refer to this user guide or visit wiki.gigaset.com.

For online information and services concerning

- Products
- Documents
- Interop
- Firmware
- FAQ
- Support

please refer to wiki.gigaset.com.

For further information our Gigaset specialised reseller will be happy to help you related to your Gigaset product.

Authorisation

This device is intended for use worldwide. Use outside the European Economic Area (with the exception of Switzerland) is subject to national approval.

Country-specific requirements have been taken into consideration.

Gigaset Communications GmbH hereby declares that the following radio equipment types are in compliance with Directive 2014/53/EU and the Radio Equipment Regulations 2017:
Gigaset N870/E SPK PRO_Gigaset R700H SPK PRO

The full text of the EU and UK declaration of conformity is available at the following internet address: www.gigaset.com/docs.

This declaration could also be available in the "International Declarations of Conformity" or "European Declarations of Conformity" files.

Therefore please check all of these files.

Data protection

We at Gigaset take the protection of our customers' data very seriously. It is precisely for this reason that we are ensuring all our products feature "Privacy by Design" as standard. All information we collect is used to make our products as good as possible. In the process, we ensure your details are protected and only used for the purposes of making available to you a product or service. We know which path your data takes through the company and ensure this happens in line with data protection specifications in a secure and protected manner.

The full text of the privacy policy is available from: www.gigaset.com/privacy-policy

Environment

Environmental management system

Further information on environmentally friendly products and processes is available on the Internet at www.gigaset.com.



Gigaset Communications GmbH is certified pursuant to the international standards ISO 14001 and ISO 9001.

ISO 14001 (Environment): Certified since September 2007 by TÜV SÜD Management Service GmbH.

ISO 9001 (Quality): Certified since 17/02/1994 by TÜV SÜD Management Service GmbH.

Disposal

Batteries should not be disposed of in general household waste. Observe the local waste disposal regulations, details of which can be obtained from your local authority.

All electrical and electronic products should be disposed of separately from the municipal waste stream via designated collection facilities appointed by the government or the local authorities.



This crossed-out wheeled bin symbol on the product means the product is covered by the European Directive 2012/19/EU.

UK: The Waste Electrical and Electronic Equipment Regulations 2013.

The correct disposal and separate collection of your old appliance will help prevent potential negative consequences for the environment and human health. It is a precondition for reuse and recycling of used electrical and electronic equipment.

For more detailed information about disposal of your old appliance, please contact your local council refuse centre or the original supplier of the product.

Care

Wipe the device with a **damp** cloth or an antistatic cloth. Do not use solvents or microfibre cloths.

Never use a dry cloth; this can cause static.

In rare cases, contact with chemical substances can cause changes to the device's exterior. Due to the wide variety of chemical products available on the market, it was not possible to test all substances.

Impairments in high-gloss finishes can be carefully removed using display polishes for mobile phones.

Contact with liquid

If the device comes into contact with liquid:

- 1 Unplug all cables from the device.
- 2 **Remove the batteries and leave the battery compartment open.**
- 3 Allow the liquid to drain from the device.
- 4 Pat all parts dry.
- 5 Place the device in a dry, warm place **for at least 72 hours (not in a microwave, oven etc.)** with the battery compartment open and the keypad facing down (if applicable).
- 6 **Do not switch on the device again until it is completely dry.**

When it has fully dried out, you will normally be able to use it again.

Technical details

Handset batteries

Technology	Nickel metal hydride(NiMH)
Size	AAA (Micro, HR03)
Voltage	1.2 V
Capacity	750 mAh

Each handset is supplied with four recommended batteries.

Operating times/charging times for batteries

The operating time of your Gigaset devices depends on the capacity and age of the batteries and the way they are used (all times are maximum times).

Handset stand-by time	320 hours
Handset operating time	13 hours
Handset charging time	8.5 hours

Power adapter (base station/powerbank)

Manufacturer	Salom Electric (Xiamen) Co. Ltd. Commercial registration number: 91350200612003878C 31 Building, Huli Industrial District, Xiamen, Fujian 361006, P.R. China				
Model identifier	C793 (USB-C PD)				
Input voltage	100-240V				
Input AC frequency	50 / 60 Hz				
Output voltage	5 V	9 V	10 V	12 V	15 V
Output current	3 A	3 A	3 A	2.5 A	2 A
Output power	15 W	27 W	30 W	30 W	30 W
Average active efficiency	> 81.4 %	> 86.6 %	> 87.0 %	> 87.0 %	> 87.0 %
Efficiency at low load (10%)	> 71.4 %	> 76.6 %	> 77.0 %	> 77.0 %	> 77.0 %
No-load power consumption	< 0,10 W				

Power adapter (handset)

Manufacturer	Salom Electric (Xiamen) Co. Ltd. Commercial registration number: 91350200612003878C 31 Building, Huli Industrial District, Xiamen, Fujian 361006, P.R. China
Model identifier	C778 / C780 (USB-A)
Input voltage	230 V
Input AC frequency	50 Hz
Output voltage	5 V
Output current	2 A
Output power	10 W
Average active efficiency	> 81.9 %
Efficiency at low load (10%)	> 75 %
No-load power consumption	< 0.10 W

Accessories

Ordering Gigaset products

You can order Gigaset products from your specialist retailer.

Case with measuring equipment	Part number
DECT Site Planning Kit (SPK) PRO	S30852-S2737-R13

Spare parts for the DECT Site Planning Kit (SPK) PRO

Spare part	Part number
Measuring base station DECT Site Planning Kit (SPK) PRO	S30852-G2716-R701
Base station tripod mount	C39363-L569-B1
Powerbank	S30852-S2737-R11
Powerbank tripod mount	S30852-S2737-R14
Calibrated R700H SPK PRO measuring handset	S30852-G2976-R702
R700H SPK PRO charging cradle	S30852-S2986-R101
Cable USB A / Cradle	V30146-A2147-D514
Cable USB-C PD / 12V, 3m	V30146-A4028-D514
Cable USB-C PD / 12V, 0.5m	V30146-A1085-D514
Cable USB2.0 / 3A	V30146-A1083-D514
Power adapter, 30 W USB-C	C39280-Z4-C793
Power adapter, USB-A	C39280-Z4-C778
Headset	S30853-S1217-R101

Index

-
- A**
- Advanced measurement mode 13
 - Antenna mode, changing 22
 - Authorisation 25
-
- B**
- Batteries 27
 - inserting in handset 10
 - technical data 27
 - Broken display 3
-
- C**
- Calibrated handset 13
 - Care 26
 - Care of the device 26
 - Charging cradle, connecting 11
 - CLI command measure-dump 19
 - Contact with liquid 27
 - CSV files 20
 - Customer Care 25
 - Customer Service 25
-
- D**
- Data protection 25
 - Display
 - broken 3
 - in idle mode 17
 - in metering mode 14
 - not in idle mode 17
 - Disposal 26
 - Download
 - via CLI 19
 - via Web user interface 18
 - dps.csv 21
-
- E**
- Emergency numbers
 - not possible 3
 - Environment 26, 29
-
- F**
- Frame quality 17
-
- H**
- Handsfree mode 12
 - Headset, connecting 11
 - Hearing
 - prevent loss of 3
 - Help 25
-
- I**
- Intercell handover 16
-
- L**
- Liquid 27
 - Loss of hearing 3
-
- M**
- measure-dump 19
 - Measurement
 - log 14
 - starting 13
 - stop 14
 - Measurement data
 - checking 20
 - download via CLI 19
 - download via Web user interface 18
 - evaluation 18
 - saving 14
 - Measurement values
 - display in handset 13
 - logging 14
 - measurement.csv 20
 - Measuring base station
 - default settings 21
 - mounting on tripod 8
 - setting up 7
 - Measuring equipment 5
 - Measuring handset
 - accessories 10
 - activating/deactivating 12
 - calibrated 13
 - charging batteries 11
 - connecting the charging cradle 11
 - connecting to another handset 12
 - inserting batteries 10
 - not calibrated 13
 - operating 12
 - starting up 10
 - Medical equipment 4
 - Metering mode
 - changing settings 15
 - display on handset 17
 - Metering mode, setting 15
 - Metering mode, simple 14
 - activating/deactivating 15
 - display 17
 - Metering range, setting 15
-
- N**
- No Intercell HO, setting 16
 - No Roaming, setting 16
 - Not calibrated handset 13

P	
Package contents	5
Power adapter	3, 28
Power level charging indicator	8
Power supply	9
alternative	9
Powerbank	
charging	7
charging status	8
connection to base station	9
connectors	7
power level	8
Provisioning template	22
uploading	24

R	
Roaming	16

S	
Safety precautions	3
Signal strength	17
Slot pair	17
Static IP address, changing	24

T	
tar file	19
Time slot	17
Tripod	6

W	
Web user interface	18

Issued by

Gigaset Communications GmbH
Frankenstraße 2, D-46395 Bocholt

© Gigaset Communications GmbH 2023

Subject to availability.

All rights reserved. Rights of modification reserved.

wiki.gigaset.com