

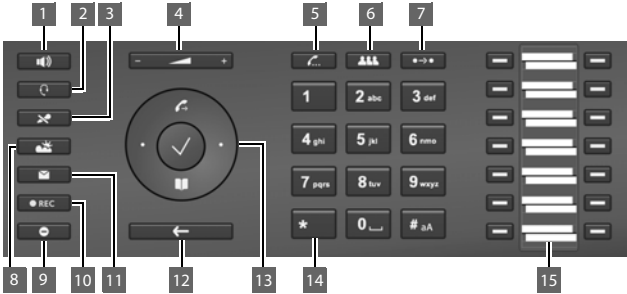









Gigaset DE700 IP PRO – Overview











- 1 **Handsfree key**
Activate/deactivate speaker
- 2 **Headset key**
Call using the headset
- 3 **Mute key**
Activate/deactivate the microphone
- 4 **Volume key**
for speaker, handset, headset or ringtone
- 5 **Inquiry call key**
Initiate/end an inquiry call
- 6 **Conference key**
Initiate a conference call
- 7 **Transfer key**
Transfer a call
- 8 **Information centre**
Access to the information centre
- 9 **Silent key**
Do-Not Disturb (DND) key
- 10 **Record call key**
Record the call
- 11 **Message centre**
Access to call and message lists
- 12 **End/back key**
Cancel function; go back one menu level (press briefly); back to idle mode (press and hold)
- 13 **Control key**
Direct access to menu and phone functions
- 14 **Star key**
Deactivate the ringtone
- 15 **Function keys**
Programmable keys







LEDs

	Flashes	Incoming call		Lights up	One or more callers are in the queue
	Lights up	Call over the speaker (handsfree).		Flashes	Incoming call on the number programmed on this key.
	Lights up	The microphone is muted.		Lights up	Call is made on this programmed number
	Flashes	New message in the message centre.			
	Lights up	The call is recorded			
	Lights up	"Do-not-disturb" function is activated.			

Control key

	In idle mode:		Opens the main menu.
			Opens the directory.
	In menus and lists:		Opens the redial list.
			Depending on the operating mode: Selects entry, saves setting, confirms action.
	In input boxes:		Navigates one line up/down.
			Moves the cursor character by character to the right/left.
		Moves the cursor line by line up/down (with multi-line entry).	

Message key







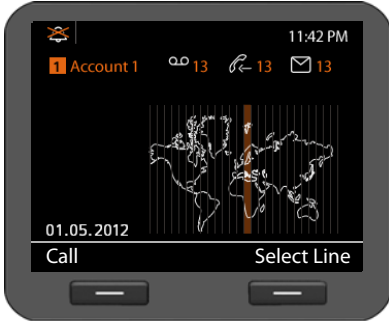



Open the message centre using the  message key.	
 Voicemail (network mailbox)	 Emails
 Missed calls	 Missed appointments
The  message key flashes if there is a new entry for one of these types of messages.	

Display



The display provides fast access to all phone functions. When the handset is in idle mode, important general information and the phone's status is shown on the display.

Display icons		Time
Active account		New voicemail, missed calls and messages in the message centre
Date		Area of application Adjustable display, e. g. time zone, time, calendar, screen image
		Display key functions
		Display keys

Icons

	New message in the message centre.		Phone in conference mode.
	Microphone switched to mute.		Secure connection.
	Call over the speaker (handsfree). Flashes with an incoming call.		Connection in HDSP quality.
	Headset connected.		New messages in the network mailbox.
	Ringtone deactivated.		Missed calls.
	New emails in the box.		Alarm function activated. The alarm time is displayed to the right.

Calling

-  Lift handset to make a call using the phone's handset.
-  Press the handsfree key to make a call over the speaker.
-  Press the headset key to make a call over the headset.

You can toggle between handset/headset mode at any time during a call.

Making calls

-  Enter the call number, lift the handset.





Cancel dialling

-  Press the end key.

Ending the call

-  Replace handset (or end key ).

While entering the call numbers

-    <  to delete an incorrectly entered number.



Dialling with the function key

Requirement: The call number is saved in this key for speed dialling. This is possible using the phone's Web configurator or using the phone system.

-  Press the function key. The number saved for the function key is dialled.



Withholding number when calling

You can withhold your number for the next call.

-    Enter the call number or transfer number from the directory.

Accepting calls

You will hear the ringtone and the  handsfree key flashes. The call appears in the display.

-  Replace handset or press  or  for handsfree mode. You can now talk to the caller.

Handsfree mode, switching to mute, ringtone

Handsfree mode



To activate using the handset during a call:

-  Press the handsfree key and replace the handset.

Switching to mute

-  Press the mute key during the call. Press the key again to switch on the microphone again.

Loudspeaker mode

-   Switch on handsfree mode.

-  Press the mute key.

You can hear the person calling over the speaker but the caller cannot hear you.

Adjusting the volume of the handset, speaker or headset

-  Press on the left to reduce the volume and on the right to increase the volume.

Adjusting the ringtone volume

-  Press on the left to reduce the volume and on the right to increase the volume while the phone is ringing.

Do-Not Disturb (DND) mode

-  Press the key to activate the DND mode. You are not notified of incoming calls and the caller hears the Busy tone.

Deactivating the ringtone permanently

-  Press and **hold** the star key. The phone will not ring with an incoming call. Press again to reactivate the ringtone.

Call lists

The following types of calls are stored: outgoing calls (redial list), accepted calls, missed calls.

Calls Display the call lists, select the list you require.

Dialling call numbers from the call list

The last call or the last call number dialled is displayed.

- ☉ Select another entry, if required.
- ☞ Lift the handset. The number is dialled.

Copying entries from the call list into the local directory

- ☉ Scroll through the list until you find the name you want.

Press Options .

- ☉ Select **Copy to Directory** and press **OK** to confirm.

The directory opens. You can add a new entry to the directory or change an existing entry.

Directory

Dialling numbers

- ☞ Press the ☉ control key to open the directory.
Press briefly : Internal directory.
Press and hold: display all directories.
- ☉ Scroll through the list until you find the name you want.
- ☞ Lift the handset. The **Default Number** of this entry is dialled.

Note: You can also search for call numbers in online directories and/or a company directory if they are available.

Entering new contacts

- ☞ Press the ☉ control key to open the directory.
Press Options and press **OK** to confirm the **New Entry** action.

New Entry

☞ ☉ @ ☰ i

First Name:
|

Surname:
|

Picture:
|

Abc ▼

Back Save

An entry includes the following information:

- ☞ Name and photo, if available
- ☞ Call numbers; up to seven numbers possible, select one as **Default Number**.
- @ Email, web address, fax
- ☰ occupation, company, address
- i Birthday, time zone, notes
- ☉ Scroll from tab to tab.
- ☉ Navigate from field to field or in the tab level.
- Save** Save the directory entry once you have entered all the data.

See the user guide for details on how to enter text.

Calls involving several participants

Inquiry calls

You want to make an inquiry call to a second person during a call. The first call is put on hold. The person on hold hears a message or an on-hold tune.

 Press the inquiry call key.

 Enter the call number of the second person you want to call.

Ending the inquiry call

 Press the inquiry call key again. You will then be connected to the first person you were talking to again.

Toggling

You are talking to one person; another is put on hold, for example, because you have accepted a waiting call or you have put a call on waiting. Both people are displayed. You can toggle between both of them.

 Press the inquiry call key to toggle between both callers.

To start an inquiry call with a third person:

Add Particip.

Both other callers are put into the queue.

 Enter the call number of the third person you want to call.

Dial The number is dialled.

To talk to another person in the queue after ending the inquiry call:

 Select the person you want to talk to.

 Press the inquiry call key.

Conference

You are talking with one or more call participants and you want to include another participant.

 Press the conference key.

 Enter the call number of the other person you want to call.

Dial The number is dialled.

If the person you are calling responds, he or she is automatically switched into the conference call.

Or

You are talking to one person and another is put on hold.

 Select the person on hold.

 Press the conference key to add the person on hold to a conference call.

All conference callers are displayed.

Logging callers out of the conference:

 Select a caller.

Remove End the conference call for the selected person.

Call pick-up



You can accept incoming calls on your phone for other call numbers that are not assigned to your phone.

Requirement: The call numbers are configured as function keys on the phone system.

A function key flashes when there is an incoming call on this number.

 Press the function key. The call is then transferred to your phone.

Note: You can alternatively pick up calls on your phone using the

  keys and the call number of the user who called.

Forwarding calls

You are talking to one person and want to forward the call to a third party.

 Press the transfer key. The call is put on hold.

 Enter the call number of the person to whom you want to forward the call.

Forwarding without inquiry:

 Press the transfer key again. The connection is forwarded to the person who has called. Your connection to this caller is then ended.

Forwarding with inquiry:

Dial The number is dialed. Wait until the person accepts the call to announce that, for example, you are going to forward the call. Then press the  transfer key.

Forwarding to a person on hold:

You are talking to one person and other persons are on hold. You can forward the call to one of the persons waiting in the queue.

 Select one of the persons waiting.

 Press the transfer key. The selected person is connected to the person to whom you are currently talking.

Call waiting

You hear the call waiting tone during a call. You can accept or reject the call.

Accepting the call:

Accept You are connected to the person waiting in the line. The first person hears an on-hold tune. The number is displayed and is highlighted as the person waiting in the call queue with the  icon.

Rejecting the call:

Reject Reject the waiting call.

Ending the call:

 Select a connection.

Remove End the selected connection.

Redirecting calls

✓ → **Select Services** → **Call Divert**

The list includes the connections configured for your telephone.

 Select the connection you require and press **OK** to confirm.

 Select when you want to activate the call forwarding function (**All Calls**, **No Answer**, **When Busy**, **Off**) and press **OK** to confirm.

 Enter the call number to where you want to forward the calls.

Save Save the settings for this connection.

Function keys

You can assign frequently used functions or call numbers to the function keys. You can either use the web configurator to assign functions to the function keys or accept the functions already assigned to your phone system's keys.

Starting the web configurator

- ▶ Launch the web browser on your PC.
- ▶ Enter the IP address into the browser's address bar. The web configurator log-on screen appears opens.

Note: You can find the IP address on the phone's display menu under settings (✓ → **Settings** → **Info**).

- ▶ **OK** click.

Assigning call numbers to function keys

- ▶ Select **Settings** → **Functions** from the web configurator menu.

All the available function keys are displayed with **Call Number** and **Program Keys**.

- ▶ Click **Edit** to assign a call number or function to a **Key**.
- ▶ Select the function you require from the **Select Function** list. For example: **Speed Dial** assign a number direct dial to a function key.
 - ▶ **Call Number** entering a direct dial on a function key
- ▶ Click **Save** to accept the key shortcuts.

Key shortcuts

For access to the phone system functions for Gigaset T300 PRO/Gigaset T500 PRO

* 2 <small>abc</small>	+ Call number	Marking calls as private.
* 3 <small>def</small> 2 <small>abc</small>	+ Group ID	Logging the user into the group.
* 3 <small>def</small> 3 <small>def</small>	+ Group ID	Logging the user out of the group.
* 6 <small>nmno</small>	+ Speed dial	Calling a number using speed dial.
* 7 <small>pqrs</small> 7 <small>pqrs</small>	+ Login ID	Logging on to the phone.
* 7 <small>pqrs</small> 8 <small>tuvw</small>	+ Login ID	Logging out of the phone.
* 7 <small>pqrs</small> 9 <small>wxyz</small>		Logging all users out of the phone.
* 8 <small>uvwx</small>	+ Internal call number	Picking up a call for the user with this call number.
* 8 <small>uvwx</small>		Randomly picking up a call.
* 9 <small>wxyz</small>	+ Voicemail box ID	Checking for voicemail.
* * *	+ Number	Establishing a call via a line with corresponding line prefix.

During a call

* *	Call2Go: Forwarding a call to your other phones.
* 1	Note: Only available from Gigaset T300 PRO/Gigaset T500 PRO software version 5 upwards. Recording a call and sending as voicemail.
* 2 <small>abc</small>	+ Call number Transferring a call with inquiry function.

Additional service features

* 0 <small>uvwx</small> 1 1	+ Target call number	Activating the general redirect function for all calls (Always) to one target call number.
* 0 <small>uvwx</small> 1 0 <small>uvwx</small>		Deactivating the redirect function.
* 0 <small>uvwx</small> 2 <small>abc</small> 1	+ Target call number	Activating the redirect function for all calls to the target call number when busy.
* 0 <small>uvwx</small> 2 <small>abc</small> 0 <small>uvwx</small>		Deactivating the redirect function for all calls when busy.
* 0 <small>uvwx</small> 3 <small>def</small> 1	+ Target call number	Activating the redirect function for all calls to the target call number on timeout (no response).
* 0 <small>uvwx</small> 3 <small>def</small> 0 <small>uvwx</small>		Deactivating the redirect function for all calls on timeout.
* 0 <small>uvwx</small> 7 <small>pqrs</small> 1		Activating the callback function when the line is busy.
* 0 <small>uvwx</small> 7 <small>pqrs</small> 0 <small>uvwx</small>		Deactivating the callback function when the line is busy.
* 0 <small>uvwx</small> 8 <small>uvwx</small>	+00 to 99 (waiting ID)	Placing a held caller in a call queue or taking a caller from the queue.
* 0 <small>uvwx</small> 9 <small>wxyz</small> 1		Activating the Do-Not-Disturb (DND) function for all phones.
* 0 <small>uvwx</small> 9 <small>wxyz</small> 0 <small>uvwx</small>		Deactivating the Do-Not-Disturb (DND) function for all phones.

Managing conference calls

*	Accessing the control options language menu.
* 1	Activating and deactivating mute (microphone).
* 2 <small>abc</small>	Requesting to speak if the moderator has activated the mute function.
* 3 <small>def</small>	Moderator: Blocking and unblocking conference calls.
* 4 <small>ghl</small> (... 4 <small>ghl</small>) 8 <small>uvwx</small>	Gradually reducing the handset volume. [8 <small>uvwx</small>] = save.
* 6 <small>nmno</small> (... 6 <small>nmno</small>) 8 <small>uvwx</small>	Gradually increasing the handset volume. [8 <small>uvwx</small>] = save.
* 7 <small>pqrs</small> (... 7 <small>pqrs</small>) 8 <small>uvwx</small>	Gradually reducing the microphone volume. [8 <small>uvwx</small>] = save.
* 9 <small>wxyz</small> (... 9 <small>wxyz</small>) 8 <small>uvwx</small>	Gradually increasing the microphone volume. [8 <small>uvwx</small>] = save.

Issued by

Gigaset Communications GmbH

Frankenstr. 2a, D-46395 Bocholt

© Gigaset Communications GmbH 2012

All rights reserved. Subject to availability.

Rights of modification reserved.

www.gigaset.com

A31008-M2211-L101-2-7643