

Gigaset pro



Maxwell 3

BECAUSE IT'S YOUR BUSINESS.



# Contents

|  |           |
|--|-----------|
| <b>Overview</b> .....                                      | <b>2</b>  |
| Keys .....   | 2         |
| Connections .....  | 4         |
| Illustration in the user guide .....                       | 5         |
| <b>Safety precautions</b> .....                            | <b>6</b>  |
| <b>Using the telephone</b> .....                           | <b>7</b>  |
| Getting to know your telephone .....                       | 7         |
| Making calls .....   | 12        |
| Call lists .....   | 20        |
| Message Centre .....                                       | 22        |
| Voice mails .....  | 23        |
| Directories .....  | 24        |
| <b>Settings</b> .....                                      | <b>28</b> |
| Basic settings .....                                       | 28        |
| Configuring other settings with the Web configurator ..... | 33        |
| Status of the telephone .....                              | 42        |
| <b>Appendix</b> .....                                      | <b>43</b> |
| Service (Customer Care) .....                              | 43        |
| Manufacturer's advice .....                                | 43        |
| Menu tree .....  | 46        |
| Display icons .....  | 47        |
| <b>Index</b> .....   | <b>48</b> |



If the telephone is connected to a telephone system, the telephone system can have a bearing on the telephone functions or block or add to them.

Further information: → User guide for the telephone system

This guide is aimed at telephone users.

Information for administrators: → [wiki.gigasetpro.com](http://wiki.gigasetpro.com)

# Overview

## Keys









|   |                     |  |                    |
|---|---------------------|--|--------------------|
| 1 | <b>Display keys</b> | Activate the display key functions   | → p. 7             |
| 2 | <b>Volume keys</b>  | Depending on the operating mode: Adjust the volume of the speaker, receiver, headset or ringtone | → p. 16            |
| 3 | <b>Star key</b>     | Display special characters when inputting text<br>Activate/deactivate the ringtone               | → p. 11<br>→ p. 15 |
| 4 | <b>Hash key</b>     | Switch text mode (upper/lower case letters, digits)<br>Lock/unlock the keypad                    | → p. 11<br>→ p. 11 |

|    |  |  |   |
|----|--|--|---|
| 5  | <b>Status LED</b><br> | Status display for incoming calls<br>Flashes: Incoming call<br>Lights up: Call in progress   |   |
| 6  | <b>Function keys</b>   | Programmable keys<br>LED function depends on the key assignment  | → p. 8<br>→ p. 38                       |
| 7  | <b>Control key</b>   | Scroll through lists and entries. In idle status:<br> Open the call list<br> Open the menu<br> Open the directory | → p. 9<br>→ p. 20<br>→ p. 10<br>→ p. 24 |
| 8  | <b>Do Not Disturb key</b>  | Activate/deactivate Do Not Disturb (DND)<br>Lights up: "Do Not Disturb" function is activated  | → p. 15                                 |
| 9  | <b>Message Centre</b>  | Open call and message lists<br>Flashes: New message in the Message Centre  | → p. 20                                 |
| 10 | <b>Consultation call key</b>   | Initiate/end consultation call; put participant on hold  | → p. 18                                 |
| 11 | <b>End/back key</b>  | Cancel function;<br>go back one menu level (press briefly);<br>return to idle status (press and hold)  | → p. 10<br>→ p. 10                      |
| 12 | <b>Conference call key</b>   | Initiate conference call   | → p. 18                                 |
| 13 | <b>Handsfree key</b>   | Activate/deactivate speakers<br>Start dialling<br>Lights up: Call is being made via the speaker<br>(handsfree mode)  | → p. 16<br>→ p. 12                      |
| 14 | <b>Headset key</b>   | Make call via headset<br>Start dialling<br>Lights up: Call is being made via the headset   | → p. 14<br>→ p. 12                      |
| 15 | <b>Mute key</b>  | Activate/deactivate microphone (mute)<br>Lights up: The microphone is muted  | → p. 16                                 |
| 16 | <b>Microphone</b>  | Microphone of the handsfree unit   |   |



## Connections













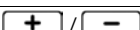

- 1  Expansion module with additional function keys
- 2  LAN (PoE)
- 3  PC; a PC can also be connected to the telephone instead of to the local network, the telephone establishes the network connection
- 4  Receiver
- 5  Headset with RJ11 plug
- 6 **EHS** EHS headset (Electronic Hook Switch)
- 7  **12V**  $\equiv$  Power adapter
- 8  USB

## Illustration in the user guide

### Icons



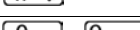

|  |   |
|--|---|
|  | Important information regarding function and appropriate handling or functions that could generate costs. |
|  | Prerequisite for carrying out the following action.   |
|  | Additional helpful information.   |









### Keys

|  |                          |   |                    |
|--|--------------------------|---|--------------------|
|  | Handsfree key            |  | Do not disturb key |
|  | Headset key              |  | Message key        |
|  | End/Back key             |  | Volume keys        |
|  | Conference call key      |  | Hash key           |
|  | Consultation call key    |  | Star key           |
|  | Mute key                 |  | Digit/letter keys  |
|  | Control key rim / centre |   |                    |
| OK, Back, Select, Save, ...  |                          | Display keys  |                    |

### Procedures

**Example:** Setting the display language

- ▶  ▶ ... use  to select  **Settings** ▶ OK ▶ **Language** ▶ OK ▶ ... use  to select the language ▶ **Select** ( = selected)

| Step  | Follow this procedure   |
|---|---|
| ▶    | Press the <b>centre</b> of the Control key in idle status.<br>The main menu opens.  |
| ▶  <br>▶ OK | Navigate to the  icon using the Control key  .<br>Press OK to confirm. The submenu <b>Settings</b> opens. |
| ▶ <b>Language</b><br>▶ OK   | Select the <b>Language</b> entry using the Control key  .<br>Press OK to confirm. The submenu <b>Language</b> opens.   |
| ▶    | Press the Control key  to select the language required.  |
| ▶ <b>Select</b>   | Press the Display key <b>Select</b> to highlight the entry.<br>The selected option is indicated with  .  |

## Safety precautions

Read the safety precautions and the user guide before use.



**Comprehensive user guides for all telephones and telephone systems as well as for accessories can be found online at [www.gigasetpro.com](http://www.gigasetpro.com) in the Support category. We thereby help to save paper while providing fast access to the complete up-to-date documentation at any time.**



Use only the power adapter indicated on the device.

Use only the cable supplied for LAN connection and connect it to the intended ports only.



Using your telephone may affect nearby medical equipment. Be aware of the technical conditions in your particular environment, e.g., doctor's surgery. If you use a medical device (e.g., a pacemaker), please contact the device manufacturer. They will be able to advise you regarding the susceptibility of the device to external sources of high frequency energy (for the specifications of your Gigaset product see "Specifications").



The devices are not splashproof. For this reason do not install them in a damp environment such as bathrooms or shower rooms.



Do not use the devices in environments with a potential explosion hazard (e.g., paint shops).



Remove faulty devices from use or have them repaired by our Service team, as these could interfere with other wireless services. Disconnect the telephone network connector (TNV circuit connector).



The device cannot be used in the event of a power failure. It is also not possible to transmit emergency calls



To connect the phone to the local network and PC only use shielded cables.





# Using the telephone

## Getting to know your telephone

### Display

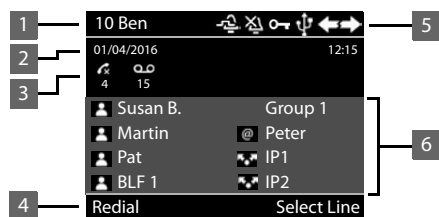
Display in idle status (example):



- 1 Name of the standard connection, possibly abbreviated (is allocated by the administrator e. g. extension and/or name of the telephone user) → p. 12
- 2 Date and time → p. 28
- 3 Message display:
  -  New messages on the answer machine → p. 23
  -  Missed calls → p. 20
- 4 Display key functions → p. 7
- 5 Status icons → p. 47
- 6 Assignment of the function keys → p. 8



Setting/modifying display colours: → p. 31

Setting date and time: → p. 28

### Display keys

The display keys perform a range of functions depending on the operating situation.

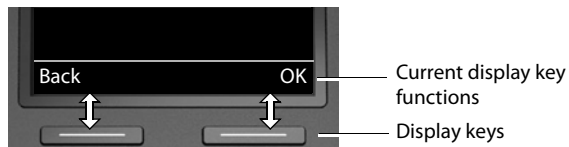

## Function keys

Programmable function keys offer rapid access to frequently used numbers and functions. The current assignment is displayed in idle status.

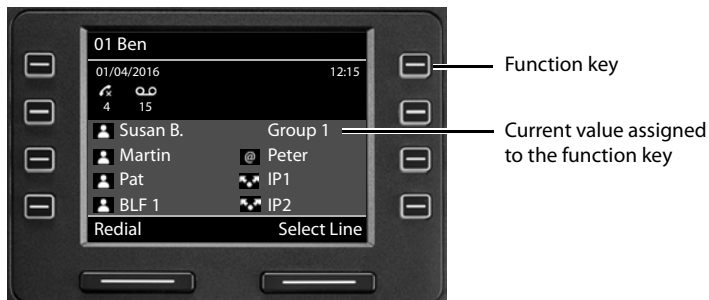



Assigning values to the function keys with the Web configurator: → p. 38

## Control key



The Control key enables you to navigate the menus and input fields, and also to call up certain functions depending on the situation.

In the description below, the side of the Control key (up, down, right, left) that you have to press in the different operating situations is marked in black, e. g.  for "press right on the Control key" or  for "press the centre of the Control key".

### In idle status

Open the main menu

Open the call lists

Open the directory assigned to the key

Open the list of available directories



**Briefly press** 

**Press and hold** 

### In submenus and lists and selection fields

Select/confirm function

Scroll one line upwards/downwards

Scroll the list upwards/downwards



**Briefly press** 

**Press and hold** 

### In input fields

Moves the cursor up/down line by line

Moves the cursor to the left/right **one character at a time**

Moves the cursor rapidly to the left/right



**Briefly press** 

**Briefly press** 

**Press and hold** 

### During a conversation

Open the directory

Open the list of available online directories



**Briefly press** 

**Press and hold** 

## Menu navigation

The functions of the telephone are displayed in a menu that consists of several levels.

Menu overview → p. 46

### Main menu

In idle status: ▶ Press the **centre** of the Control key .

The functions of the display menu are displayed each with their icon.

The submenu selected is shown inverted.

- ▶ ... Use the Control key  to select a submenu
- ▶ Press the Display key **OK**

or

- ▶ Press the Control key 

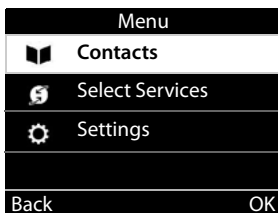

### Submenus

The functions in the submenus are displayed as lists. The selected function is highlighted.

- ▶ ... Use the Control key  to select a function
- ▶ Press the Display key **OK**

or

- ▶ Press the Control key 

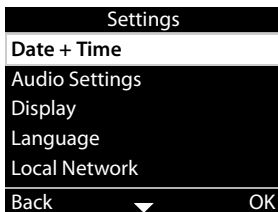

If not all the functions can be displayed, arrows are shown below.

Displaying more list entries: ▶ ... scroll in the direction of the arrow with the Control key .

### Returning to the previous menu level

- ▶ Press the Display key **Back**

or

- ▶ press the End key  briefly

### Returning to idle status

- ▶ Press and **hold** the End key 





If a key is not pressed, after 3 minutes the display will **automatically** change to idle status.

Settings which have not been saved or confirmed are rejected.

## Entering text



### Input position

- ▶ Use  to select an entry field. A field is activated when the cursor is blinking inside it.
- ▶ Use  to move the position of the cursor.

### Correcting incorrect entries

Delete **characters** to the left of the cursor: ▶ 

### Entering letters/characters

Multiple letters and digits are assigned to each key between  and  and the  key. As soon as a key is pressed, the possible characters are displayed at the bottom of the display.

The selected character is highlighted.



Select letters/digits:

- ▶ Press the key **briefly** several times in succession

Switch between lower case, upper case and digit entry mode:

- ▶ Press the Hash key  ... the mode set is displayed at the bottom on the right  
When editing a directory entry, the first letter and each letter following a space is automatically in upper case.

Entering special characters:



- ▶ Press the Star key  ... the available special characters are displayed ▶ ... use  to navigate to the character you want ▶ **OK**

| Edit Entry  |         |
|-------------|---------|
| First Name: | Pa      |
| Surname:    | Artmann |
| abc2ääääääç | abc     |
| Back        | Set     |

## Locking/unlocking the keypad

The keypad lock prevents any accidental use of the telephone.

Locking the keypad: ▶ Press and **hold**  ... the following icon appears on the display 

Unlocking the keypad: ▶ Press and **hold**  ▶ ... use  to enter the keypad lock PIN (default setting: 1234) ▶ **OK**



Changing the keypad lock PIN with the Web configurator: ➔ p. 33

If a call is indicated on the handset, the keypad automatically unlocks and you can accept the call. It then locks again when the call is finished.

It is not possible to call emergency numbers either when keypad lock is activated.

## Making calls



The phone is connected to the LAN.

At least one VoIP connection has been set up and assigned to the telephone.





VoIP connections are set up by the administrator with the Web configurator or assigned using a PABX.

Up to four VoIP connections (call numbers) can be assigned to the telephone. The first connection to be set up is the standard send connection. The name of the standard send connection is displayed in idle status at the top left of the display header (→ p. 7).

No connection available: the following icon is shown in the display

Information about the telephone connections and the standard send connection:  
Web configurator → p. 42



## Making a call

▶ ... use  to enter a number ▶  lift the handset

or

▶  lift the handset ▶ ... use  to enter a number ▶ **Dial**

Calls are initiated via the standard send connection if you do not select another option. To use another VoIP connection:

▶ **Select Line** ▶ ... use  to select required connection ▶ **Dial** ▶ ... use  to enter the number ▶ **Dial**

Using the speaker to make calls: ▶  Press the Handsfree key

Using the headset to make calls: ▶  Press the Headset key



You can switch over at any time during the conversation.

In the following instructions, the icon  also always stands for  or .

When entering the call number:

Deleting incorrectly entered numbers to the left of the cursor: ▶ 

Transferring a number to the local directory: ▶  (→ p. 24)









Cancel dialling: ▶ **End**

Incoming call during number entry:

Accept the call: ▶ **Accept**







Reject the call: ▶ **Reject**

## Dialling from the directory

- ▶ ... use  to open the directory ▶  select entry ▶  lift the handset
  - or
  - ▶  ▶ ... use  to select **Contacts** ▶ **OK** ▶  select entry ▶  lift the handset
- More than one number in the directory entry: ▶ ... use  to select a number ▶ **OK**

## Dialling from the redial list

The redial list contains the most recently dialled numbers.

- ▶ In idle status press **Redial** ▶  select entry ▶  lift the handset
- or
- ▶ ... use  to open the call lists ▶  **Outgoing** ▶  select entry ▶  lift the handset

## Dialling from a call list

The call lists contain the most recent accepted, outgoing and missed calls (→ p. 20). If the number is saved in the directory, the name is displayed.

- ▶ ... use  to open the call lists ▶  select a list (**All, Accepted, Missed, Outgoing**) ▶  select entry ▶  lift the handset



The list of new missed calls can also be opened by pressing the Message key .

## Dialling a number using a function key

Dialling numbers with one press of a function key.



A number has been assigned to the function key.  
Assigning numbers to function keys: Web configurator (→ p. 38).

- ▶  Press the function key ... the number saved for the function key is dialled, the handsfree function is activated

## Ringback

Asking for a ring back when the line of a participant you have called is busy.



The PABX or the provider supports this function.

## Initiating ringback

- ▶ **Ringback** ... the ringback request is registered  
When the other participant's line is free, the ringback is initiated. The telephone rings, **Ringback** is displayed in the header.

There can be an active ringback on each line.

## Making calls

### Cancelling ringback







▶  ▶ ... use  to select  **Select Services** ▶ OK ▶  **Cancel Ringback** ▶ OK

### Anonymous calling

Withhold Calling Line Identification. The number is not shown to the person receiving the call.



The PABX or the provider supports this function.

▶  ▶ ... use  to select  **Select Services** ▶ OK ▶  **Withhold Number** ▶ OK ▶ if necessary, use  to select a line ▶ **Change**  = calls are anonymous)

### Incoming calls

An incoming call is indicated by ringing, by a display on the screen and by the flashing Status LED.

The display shows

- **Incoming Call** in the header
- the caller's name if it has been stored in the directory
- the caller's number if it has been transmitted (→ p. 14)
- the line on which the call is coming in on
- a picture of the caller, if one has been transmitted (CNIP)



Accepting the call: ▶  lift the handset

Switching the ringtone off:

▶ **Silence**

Rejecting the call:

▶ **Reject**



If the call is a ringback, **Ringback** is displayed in the header.

When a call comes in, the system looks for a matching entry in the local directory. If the number is not found there, other directories are searched, if any have been configured.



---

## Protection from incoming calls

---

### Activating/deactivating the ringtone

An incoming call is not signalled by ringing, but is displayed on the screen.

Switching the ringtone on/off: ▶ Press and **hold** the Star key 

Ringtone is switched off: the following icon appears on the display 





Ringtone silencing for anonymous calls: → p. 29.

---

### Switching the alert tone (beep) on/off

Switch on an alert tone (beep) instead of the ringtone:

▶ Press and **hold** the Star key  ▶ press **Beep** within 3 seconds ... the following icon appears in the status line 

Switching off the alert tone: ▶ Press and **hold** the Star key 

---

### Switching the "Do not disturb" function on and off

Incoming calls are not signalled.

Switching "Do not disturb" on or off: ▶ Press the Do not disturb key 

"Do not disturb" is switched on: the Do not disturb key  is illuminated, the display shows "**Do not disturb**" active



Set up call forwarding: → p. 19

The administrator can create a list of numbers which should never be signalled by the telephone in the Web configurator.

---

# During a conversation

---

## Changing the volume

Changing the volume of the handset, the handsfree function or the headset during a call.

Louder:  ▶ Save

The volume can be set at 10 levels.

Quieter:  ▶ Save

The current setting is displayed.



If there is no input for two seconds, the most recent value is stored automatically.





Permanent volume settings: → p. 29.

---

## Muting

Switching off the microphone in the handset, the handsfree facility and the headset. The other party to the call no longer hears what is being said.

Activating/deactivating the microphone: ▶ Press the Mute key 

Microphone is switched off: the Mute key  is illuminated

---

## Switching the handsfree function on/off

Making calls via the speaker and the microphone of the handsfree function.

Switching on the handsfree function during a call:

▶ Press the Handsfree key  ▶ Replace handset 

Handsfree function is switched on: the  key is illuminated

Switching off the handsfree function during a call:

▶ Lift the handset  ▶ continue the call through the handset

---

## Displaying information

### ▶ Info

Function keys assigned: The assignment of the function keys is displayed (→ p. 38)

Function keys not assigned: Information about the device is displayed (→ p. 32)

---

## Ending a call

▶ Replace the handset 

## Talking with several participants on the telephone

### Accepting/rejecting Call Waiting



The PABX or the provider supports this function and the function is activated on the telephone (→ p. 35).

Another call comes in during a conversation. The call is signalled in the display and by the Call Waiting tone. **Call Waiting** is displayed in the header.

Accepting the call:

- ▶ **Accept** ... the connection to the waiting participant is made. The first participant is put on hold and hears some on-hold music.

Rejecting the call:

- ▶ **Reject**

### Permit/prevent Call Waiting

Permit or prevent Call Waiting during a call for all or for certain lines.

- ▶ ▶ ... use to select **Select Services** ▶ **OK** ▶ **Call Waiting** ▶ **OK** ▶ if necessary, press to select line ▶ **Change** = Call Waiting is permitted)



Define settings for Call Waiting with the Web configurator → p. 35

### Consultation calls

Consulting a second participant during a conversation.

- ▶ Press the Consultation call key

or

- ▶ **Consult**

... the first conversation is put on hold

- ▶ Initiate a consultation call via the keypad or from the directory

... when the participant picks up, conduct consultation call

The display shows:

**On hold:** <Number> or <name in the directory>

Ending a consultation call:

- ▶ **End** ... the connection to the participant on hold is reactivated

or

- ▶ Replace the handset ... both calls are ended

The call on hold is transferred to the consultation participant.





## Making calls



If the consultation participant does not accept the call: a recall is initiated by the participant on hold (your telephone rings). If you accept the call, you will be reconnected to the participant previously on hold.

### Initiating consultation call from the directory

During the conversation:

- ▶ Press the Control key  ▶  select entry ▶ **Options** ▶ **Dial** ▶ **OK** ▶ ... if necessary, select the number with  ▶ **OK** ... the first conversation is put on hold, the number is dialled

or

- ▶ **Consult** ... the first conversation is put on hold ▶ **Directory** ▶  select entry ▶ **Dial** ▶ ... if necessary, use  to select the number ▶ **OK** ... the number is selected

---

## Call swapping

Switch back and forth between two participants. The other call is placed on hold.

- ▶ Call a second participant during an external conversation (consultation call) or accept a waiting call ▶ ... use **Swap** to switch between the participants

Ending the connection to the active participant:

- ▶ **End** ... the connection to the participant on hold is reactivated



Other ways of ending the call-swapping session:

- Replace the handset : The other two participants will be connected to one another.
- The **active** participant ends the conversation: The connection to the participant on hold is reactivated
- The participant **on hold** ends the conversation: The connection to the active participant remains active.

---

## Conference call

Speaking to two participants at the same time.

Initiating a conference call during a conversation:

- ▶ Press the Conference call key  ▶ call second participant ... the conference is established as soon as the call is accepted

Initiating a conference call from call swapping:

- ▶ Press the Conference call key  ... the active participant and the participant on hold will be switched into the conference

Ending a conference call:

- ▶ **End** or ▶ replace the handset  ... the conference ends for all the participants

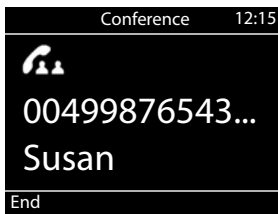

## Transferring a call

Connecting both external participants to one another during call swapping or in an external consultation call:

- ▶ Replace the handset  ... the call on hold will be transferred to the active participant.

If the active participant does not accept the call, a recall will be initiated by the participant on hold.

## Call divert





All incoming calls are diverted to another line or a network mailbox. A call divert function can be configured for every line on the telephone.





The PABX or the provider supports this function.

If calls are diverted to an answer machine, it must be set up by the administrator with the Web configurator.

Activating call divert:

- ▶  ▶ ... use  to select  **Select Services** ▶ OK ▶  **Call Divert** ▶ OK ▶ ... if necessary, use  to select a connection ▶ **Change**







- ▶ ... use  to select **Phone Number** ▶  enter number ▶ **Save**

or

- ▶ ... use  to select **Voice Mail** ▶ **Save** ... calls are forwarded to the answer machine assigned to the connection.

In idle status, the active call divert and the destination for the diverted call are shown on the display.

Deactivating call divert:

- ▶  ▶ ... use  to select  **Select Services** ▶ OK ▶  **Call Divert** ▶ OK ... connections with active call divert are marked with  ▶ ... use  to select a connection ▶ **Change**



Specifying different call diverts for engaged numbers or calls which are not picked up with the Web configurator → p. 36



## Call lists

The telephone saves different types of calls in lists. The following call lists are available:



|                       |   |
|-----------------------|---|
| <b>All Calls</b>      | All outgoing, accepted and missed calls.  |
| <b>Accepted Calls</b> | Calls that were accepted.   |
| <b>Missed Calls</b>   | Calls that were not accepted.<br>Missed calls that have not yet been viewed can also be accessed via the Message key  (→ p. 20). |
| <b>Outgoing Calls</b> | Last selected numbers (redial list).  |

If the call list is full, a new entry overwrites the oldest.

### Opening the call list



- ▶  ▶ ... use  to select a list (**All, Accepted, Missed, Outgoing**) ... the calls in the selected list type are displayed

### Information about the calls





- Icon for the call type:
  -  Missed Calls,
  -  Accepted Calls,
  -  Outgoing Calls
- Caller's number. If the number is saved in the directory, the name is displayed instead.
- Date and time of the call

| Call Lists   |          |         |          |
|--|----------|---------|----------|
| All  | Accepted | Missed  | Outgoing |
|  <b>08912345678</b><br>Today, 09:30 |          |         |          |
|  <b>Peter Brown</b><br>22.06, 11:30 |          |         |          |
| View   |          | Options |          |







Displaying more information about an entry: ▶ **View** ▶ ... use  to scroll through the entry

- Number type (if the caller is entered in the directory):  **Phone Home**,  **Phone Office**,  **Phone Mobile**
- Call duration
- Info: more information supplied by the provider (CNIP); otherwise the telephone number

### Calling back a caller

- ▶  ▶ ... use  to select a list ▶ ... use  to select entry ▶  lift handset ... the number is dialled

## Copying a number to the directory



- ▶  ▶ ... use  to select a list ▶ ... use  to select an entry ▶ **Options** ▶ **Save Number** ... then
  - Creating a new entry: ▶ **< New Entry >** ▶ **OK**
  - or
  - Adding a number to an existing entry: ▶ ... use  to select an entry ▶ **OK**
  - ▶ ... use  to select a number category ▶ **OK** ▶ ... use  to enter more data for the entry
- Save entry: ▶ **Save**



More information about the local directory: → p. 24

## Deleting entries

Deleting an entry:

- ▶  ▶ ... use  to select a list ▶ ... use  to select an entry ▶ **Options** ▶ **Delete Entry** ▶ **OK**

Deleting all the entries in the list currently selected:

- ▶  ▶ ... use  to select a list ▶ **Options** ▶ **Delete List** ▶ **OK** ▶ confirm prompt with **Yes**

## Message Centre

The Message Centre gives you quick access with a single key press to missed calls and voice mails on an answer machine.

The Message key  flashes if there are new messages. A missed call is considered new if it has been received since the **Missed Calls** list was last opened; a voice mail is considered new if it has not been listened to.



The administrator can use the Web configurator to specify which types of messages are accessible via the Message Centre.

Icons for message types and the number of **new** messages are shown in idle status.



New messages:

 on a network mailbox (→ p. 23)

 in the **Missed Calls** list (→ p. 20)

The number displayed indicates the total for all the connections involved.

Opening the Message Centre:

- ▶ Press the Message key  ▶ ... use  to select the message type (**Voice Mail** or **Missed Calls**) ▶ OK

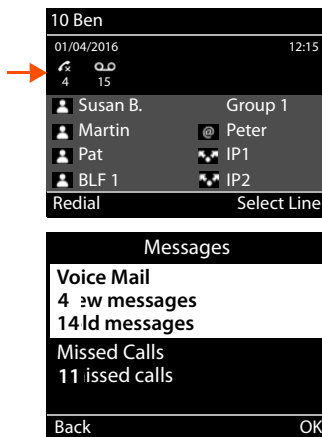

The **Voice Mail** list is always displayed, when an answer machine is stored in the telephone, the **Missed Calls** list only if it contains messages.





## Voice mails

Managing messages stored in a network mailbox. Every network mailbox accepts incoming calls on the corresponding VoIP phone number.





The administrator has entered the network mailbox(es) in the telephone with the Web configurator or there is an answer machine available with the PABX.

### Playing back voice mails

- ▶ Press the Message key  ▶ OK ▶ ... if necessary, use  to select the answer machine (connection) ▶ OK ... all the voice mails for the connection are displayed ▶ use  to select an entry ▶ Play ... the message is played back through the speaker on the telephone

Listening to messages through the handset:



- ▶  Lift the handset

Ending playback: ▶ Press the End Call key  or replace the handset 



An incoming call ends playback.

### Editing voice mails

- ▶ Press the Message key  ▶ OK ▶ ... if necessary, use  to select the answer machine (connection) ▶ OK ... all voice mails for the connection are displayed ▶  select entry ... then

Viewing call details: ▶ **View**

Deleting the recording:

- ▶ **Options** ▶ **Delete Entry** ▶ **OK**

Deleting all entries: ▶ **Options** ▶ **Delete List** ▶ **OK** ▶ Confirm prompt with **Yes**

Transferring the number to the directory:

- ▶ **Options** ▶ **Save Number** ▶ **OK** ▶ create a new entry in the directory or add the number to an existing entry (→ p. 24)

## Directories

The options are:

- Local directory
- Company directory (→ p. 26)



The local directory is pre-set as a standard directory. That means that it is the directory that is opened with the Control key and into which entries are copied with the "Copy to directory" function.

The administrator can make another directory, such as the company directory, the standard directory.

## Local directory

### Opening the directory

In idle status:

▶ Press the Control key

or

▶ ▶ ... use to select **Contacts** ▶ OK ▶ **Directory** ▶ OK

The entries are shown in alphabetical order and are sorted by last name by default.

Change sort order:

▶ **Options** ▶ **Sort by First Name** or **Sort by Surname**

| Directory          |         |
|--------------------|---------|
| Brown, Susan       |         |
| Fischer, Alexander |         |
| Meyer, Peter       |         |
| Oscar              |         |
| Smith, Elisabeth   |         |
| View               | Options |



If an entry does not include a name, the first phone number entered is stored and displayed as the last name.

## Displaying a directory entry

▶ ... use  to select an entry ▶ **View**

or

▶ enter the first letter of the name ... the first entry which starts with that letter is displayed

A directory entry can contain the following information:

- First name and last name: (max. 16 characters each)
- Up to six phone numbers (max. 32 digits each)

Two numbers can be assigned to the following categories:

 work numbers (**Phone Office 1/2**)



 private numbers (**Phone Home 1/2**)

 mobile numbers (**Phone Mobile 1/2**)



| View Entry  |                 |
|---|-----------------|
| Susan Brown   |                 |
|  | 1: 08912345678  |
|  | 2: 004456565656 |
|  | 1: 01231234567  |
|  | 1: 089998877665 |
| Edit  | Options         |

▶ ... use  to scroll through the directory entry

## Creating a new entry

▶ **Options** ▶ **New Entry** ▶ ... use  to enter data for the entry and use  to move between the entry fields ▶ **Save**

Creating a new entry with a dialled number:



▶ Enter the number ▶ -> **Dir** ▶ < **New Entry** > ▶ **OK** ▶ ... use  to select the number category ▶ **OK** ▶ ... use  to enter more data for the entry ▶ **Save**





Creating a new entry with a number from the call list: → p. 21

Information on entering text: → p. 11

## Changing an entry

▶ ... use  to select an entry ▶ **View** ▶ **Edit** ▶ ... use  to select an entry field ▶ if necessary, delete old text, enter new text ▶ **Save**





Adding a number when dialling:

▶ Enter the number ▶ -> **Dir** ▶ ... use  to select an entry ▶ **OK** ▶ ... use  to select the number category ▶ **OK** ▶ **Save**



Information on entering text: → p. 11

### Dialling from the directory

- ▶ ... use  to select an entry ▶  lift the handset
- More than one number in the directory entry: ▶ ... use  to select a number ▶ **OK**
- or
- ▶ ... use  to select an entry ▶ **View** ▶ ... if necessary, use  to select a number ▶ **Options** ▶ **Use Number** ▶ **OK**

 Initiate a consultation call from the directory: → p. 17

---

### Deleting directory entries

Delete an entry selected from the list:

- ▶  Select an entry ▶ **View** ▶ **Options** ▶ **Delete Entry** ▶ **OK** ... the entry is deleted immediately

Deleting the whole list:

- ▶ **Options** ▶ **Delete List** ▶ **OK** ▶ ... Confirm prompt with **Yes**
- 

### Company directory

If there is a directory available on your company's network you can use it on the telephone.







The administrator has set up and activated the directory in the Web configurator.

---

### Opening the company directory

In idle status:

- ▶ Press and **hold** the Control key  ▶ ... use  to select the company directory ▶ **OK**
- or
- ▶  ▶ ... use  to select  **Contacts** ▶ **OK** ▶ ... use  to select the company directory ▶ **OK**

 The company directory is shown with the name specified by the administrator in the Web configurator.

## Searching for an entry

- ▶ Enter the name (or the initial letters) . . . as soon as the entry process stops, the search starts.  
All the matching entries are displayed. If a matching entry is not found, the search field is redisplayed. You can launch a new search.

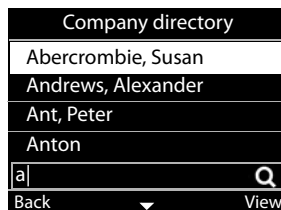

## Displaying an entry

- ▶ . . . use  to select an entry ▶ **View**

A directory entry can contain the following information (depending on the information provided by the company directory):

Personal information

**First Name;** **Surname;** **Job;** **Company:**



Numbers: **Office,** **Mobile,** **Home**

Other contact data: **Email;** **Web Address;** **Fax:**

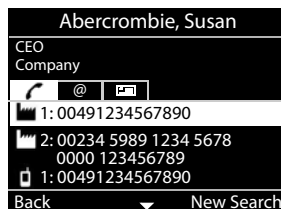
Address information: **Street;** **City;** **ZIP Code;** **Country:**



## Dialling a number from the company directory

- ▶ . . . use  to select an entry ▶  lift the handset  
More than one number in the directory entry: ▶ . . . use  to select a number ▶ **OK**

# Settings

The telephone is preconfigured. Individual settings can be modified via the display menu or on a PC using the Web configurator. Web configurator → p. 33

## Basic settings

### Date and time



The address of a time server on the Internet or on the local network is stored on your phone. The date and time are taken from this time server provided that the phone is connected to the network and synchronisation with the time server is activated. Manual settings are overwritten in this case.

Settings for the time server in the Web configurator: → p. 40

- ▶ ▶ ... use to select **Settings** ▶ **OK** ▶ **Date + Time** ▶ **OK** ... then
  - Time: ▶ ... use to enter hours and minutes in 4-digit format  
e.g. for 07:15 ▶ **Save**
  - Time format: ▶ ▶ ... use to select the time format  
**24h:** e.g. 10:00, 18:00  
**12h:** e.g. 10:00 am, 6:00 pm  
12h selected: ▶ ... use to select **Time of Day: (am / pm)**
  - Date: ▶ ▶ ... use to enter day, month and year in 8-digit format  
e.g. for 14.01.2016 ▶ **Save**
  - Date format: ▶ ▶ ... use to select date order  
**Day Month Year:** e.g. 17.04.2016      for 17 April 2016  
**Month Day Year:** e.g. 04.17.2016
  - Save the settings: ▶ **Save**

## Ringtones

Set the volume and melody for the ringtone and/or completely silence the ringtone for anonymous calls.

### Volume

The volume of the ringtone for incoming calls can be set at 10 levels.

- ▶  ▶ ... use  to select  **Settings** ▶ OK ▶  **Audio Settings** ▶ OK ▶ **Ringtones** ▶ OK ▶ **Volume** ▶ OK ...



the ringtone will be played with the melody set for external calls at the current volume; the volume is shown graphically.



- ▶ ... use  to select the required volume ▶ **Save**









Changing the volume of the ringtone during an incoming call:

- ▶ Press the volume keys  (for louder) or  (for quieter)

### Melody

Specify different ringtone melodies for different events (**External Calls**, **Internal Calls**, **Group Calls**) and VoIP connections.

- ▶  ▶ ... use  to select  **Settings** ▶ OK ▶  **Audio Settings** ▶ OK ▶ **Ringtones** ▶ OK ▶ **Melodies** ▶ OK ▶ ... use  to select event to be signalled with the melody ▶ OK ... the melody currently set for connection 1 is played ▶ ... use  to select the melody required ▶  if necessary, select melodies for the other connections ▶ **Save**



Loading more ringtones onto the phone: → p. 37

### Ringtone silencing for anonymous calls

Prevent the telephone ringing when no number is transmitted with an external call.

- ▶  ▶ ... use  to select  **Settings** ▶ OK ▶  **Audio Settings** ▶ OK ▶ **Ringtones** ▶ OK ▶ **Anonymous Call Silencing** ▶ **Edit**  (= the telephone does not ring for anonymous calls)





### Advisory tones

The handset notifies acoustically about different activities and statuses.

**Confirmations:** At the end of an entry or after making a setting and when a new entry arrives in the network mailbox or the call list, if an entry is incorrect.

**Key Click:** Each press of a key is accompanied by an acoustic signal.

These advisory tones can be switched on/off independently of each other.

▶  ▶ ... use  to select  **Settings** ▶ OK ▶  **Audio Settings** ▶ OK ▶ **Advisory Tones** ▶ OK ... then

Confirmation/error tone after making entries:

▶ ... use  to select **On** or **Off**

Tone when keys are pressed:

▶  ▶ ... use  to select **On** or **Off**

Save the settings: ▶ **Save**

---

### Display



#### Screensaver

For display as a screensaver in idle status, there is a digital or an analogue clock which have been loaded into the device memory.

▶  ▶ ... use  to select  **Settings** ▶ OK ▶ **Display** ▶ OK ▶ **Screensaver** ... then

Switch off: ... use  to select **Off** ▶ **Save**

Switch on: ... use  to select the time the display spends in idle status before the screensaver becomes active  
10, 20, 30, 40, 50 or 60 minutes

Select screensaver: ▶  ▶ ... use  to select a screensaver (**Digital Clock / Analog Clock**)

Save the selection: ▶ **Save**

#### End screensaver

▶ Press any key **briefly** ... the display changes to idle status

---

#### Brightness

The brightness can be set at 10 levels.

▶  ▶ ... use  to select  **Settings** ▶ OK ▶  **Display** ▶ OK ▶ **Brightness** ▶ OK ... the current setting is shown graphically ▶ ... use  to select the brightness required ▶ **Save**



## Colour scheme

The display can appear in a range of colour combinations.

- ▶  ▶ ... use  to select  **Settings** ▶ **OK** ▶ **Display** ▶ **OK** ▶ **Colour Scheme** ▶ **OK** ▶ ... use  to select required colour scheme ▶ **Select** ( = selected)



Changing the display settings with the Web configurator: → p. 38

## Language

Set the language for the display screen.

- ▶  ▶ ... use  to select  **Settings** ▶ **OK** ▶ **Language** ▶ **OK** ▶ ... use  to select language ▶ **Select** ( = selected)



Setting the display language with the Web configurator: → p. 38

## Local network

Display network settings for the telephone.

- ▶  ▶ ... use  to select  **Settings** ▶ **OK** ▶ **Local Network** ▶ **OK**

**IP Address Type:**

**static or dynamic**

**dynamic**

The telephone obtains its IP address automatically from a DHCP service in the network (the router, for example). The following fields show the current settings. These settings cannot be changed.

**static**

The telephone is provided with a permanent IP address. The administrator makes the network settings using the other fields.

**IP Address:**

The phone's IP address in the local network.

**Subnet Mask:**

The subnet mask for the local network. It specifies how many parts of the IP address make up the network prefix and how many parts make up the device address. The network prefix must be the same for all the devices in the local network.

**Standard Gateway:**

IP address of the system in the local network which assigns the address and forwards information to other networks. This is frequently a router.



Changes to these settings should only be made by the administrator.

## Resetting the device to the factory settings

A reset returns all the settings to the default settings. Network configuration, VoIP connections, directories, call lists and all the individual settings are deleted or restored to the factory settings.



Safeguarding personnel settings from the reset: → p. 40

▶ ▶ ... use to select **Settings** ▶ **OK** ▶ **Reset** ▶ **OK** ▶ confirm prompt with **Yes**

### Resetting using the device keys

▶ Disconnect the telephone from the mains power supply ▶ press the Control key ▶ holding the key down, reconnect the device with the power supply



Resetting the device with the Web configurator → p. 41

---

## Displaying device information

The menu entry **Info** provides information about important settings on the telephone.

▶ ▶ ... use to select **Settings** ▶ **OK** ▶ **Info** ... the following information is displayed:

|                         |  |
|-------------------------|--|
| <b>Device:</b>          | Telephone product name   |
| <b>SW Version:</b>      | Version of the firmware currently loaded on the phone.   |
| <b>Country Version:</b> | Country-specific version of the product  |
| <b>MAC Address LAN:</b> | The phone's device address.  |
| <b>IP Address:</b>      | The phone's current IP address within the local network. The IP address is usually set automatically via a DHCP server in the network. |



There is more information about the settings and the status of the telephone in the status display of the Web configurator (→ p. 42).

## Configuring other settings with the Web configurator



Your phone is connected to the local network.



This chapter describes the user functions in the Web configurator.

Information for administrators: → [wiki.gigasetpro.com](http://wiki.gigasetpro.com)

### Web configurator

#### Finding out the IP address of the phone

You need the IP address of the telephone to access the web configurator.

Displaying the IP address in the display menu of the telephone:

- ▶  ▶ **Settings** ▶ **Local Network** ... the IP address is displayed



The IP address can sometimes change, depending on the settings of the DHCP server in your network.

#### Starting the web configurator

- ▶ Open the Internet browser on the PC ▶ enter the IP address of the telephone (without any leading zeros) in the address field of the browser ... the login screen is displayed
- ▶ Select the language ▶ enter the password (preset: user) ▶ **Login** ... the Web configurator is launched, the **Ringtones** page is displayed

#### Changing the password

- ▶ Click on the  icon in the top right ▶ select **Change Password** ▶ enter new password ▶ re-enter new password ▶ **Set**



The password can also be changed by the administrator.

#### Changing the telephone PIN

The telephone PIN is used to lock the telephone keypad, for example (→ p. 11).

- ▶ Click on the  icon in the top right ▶ select **Change Phone PIN** ▶ enter current PIN (preset to 1234) ▶ enter new PIN ▶ re-enter new PIN ▶ **Set**

#### Changing the language

- ▶ Click on the  icon in the top right ▶ select **Change Language** ▶ select required language from the **Language** list ▶ **Set**

#### Ending the Web configurator

- ▶ Click on the  icon in the top right ▶ select **Logout** ... the login screen is displayed again

## Functions of the Web configurator

The following illustration shows the menu entries of the Web configurator for users.

Information on the administrator functions → [wiki.gigasetpro.com](http://wiki.gigasetpro.com)

|                    |            |                  |         |
|--------------------|------------|------------------|---------|
| Settings           | Telephony  | Connections      | → p. 35 |
|                    |            | Call Settings    | → p. 35 |
|                    |            | Call Divert      | → p. 36 |
|                    |            | Do not Disturb   | → p. 36 |
|                    | Desk Phone | Ringtones        | → p. 37 |
|                    |            | Display          | → p. 38 |
|                    |            | Keys and LEDs    | → p. 38 |
|                    | System     | Date and Time    | → p. 40 |
|                    |            | Save and Restore | → p. 40 |
|                    |            | Reboot and Reset | → p. 41 |
|                    | Status     | Device           | → p. 42 |
| Connections        |            | → p. 42          |         |
| Storage Allocation |            | → p. 42          |         |

---

## Telephony

---

### Changing the standard send connection

If the telephone has more than one VoIP connection, outgoing calls are initiated via the standard send connection (→ p. 12).

Changing the standard send connection:

▶ **Settings ▶ Telephony ▶ Connections**

All the configured connections are shown. The check box  under **Default send connection** shows which connection is currently selected.

▶ Check the connection required ▶ **Set**

Only active connections can be selected.

---

### Settings for Call Waiting

Specify the telephone's response when another call comes in during a call.

▶ **Settings ▶ Telephony ▶ Call Settings**

For each connection:

Prevent/permit Call Waiting:

▶ Select the option under **Display waiting call** ( = Call Waiting permitted) / deselect ( = Call Waiting not permitted)

Permit Call Waiting:

▶ Select **Acoustic signal** from the list

**Off:** the incoming call is shown in the display only

or signalling with a Call Waiting tone (beep): once or every 4, 10, or 20 seconds

Save the settings: ▶ **Set**

### Setting up Call Divert



The provider/the PABX supports this function.

Forwarding incoming calls to another number or a network mailbox.

▶ **Settings** ▶ **Telephony** ▶ **Call Divert**

For each connection (**Incoming line**):

- All Calls** Forward all incoming calls.  
**When Busy** Forward incoming calls when the line is busy.  
**No Answer** Forward incoming calls after a defined period if they are not accepted.

Specifying the destination of diverted calls:

▶ Check the box  under **Voicemail**

or

▶ check the box  under **Target number** ▶ enter the number, to which calls are to be diverted

For diverting calls when **No Answer**:

▶ From the **Delay** list, select the period after which Call Divert should be activated.

Activating/deactivating Call Divert:

▶ Select the option under **Active** ( = activated) / deselect ( = not activated) ▶ **Set**



Setting up Call Divert via the display menu: → p. 19

### Do not Disturb



The provider/the PABX supports this function.

Block phone numbers and/or all anonymous calls. Calls from blocked numbers are not signalled.

▶ **Settings** ▶ **Telephony** ▶ **Do not Disturb**

The black list contains all the blocked numbers.

- Activate the black list: ▶ Set the switch next to **DND list** to **Yes**  
Block a number: ▶ Enter **Name** and **Phone number** of the call ▶ click on **Add**  
Delete an entry: ▶ Click  next to the entry  
Delete all entries: ▶ Click **Delete all**  
Block all anonymous calls: ▶ Activate the option **Block anonymous callers** ( = activated)  
Save the settings: ▶ **Set**

## Desk Phone

### Specifying and loading ringtones

Set a ringtone for each configured VoIP connection or use a standard ringtone for all of them.

- ▶ **Settings ▶ Desk Phone ▶ Ringtones**

#### Selecting ringtones

The standard ringtone is used for connections or events for which no individual ringtone has been set up.

- ▶ Select a ringtone from the **Default ringtone** list ▶ click on **Play** ... the melody selected is played on the telephone ▶ **Set**

Use the standard ringtone for all calls:

- ▶ click on **Use for all calls** ▶ **Set**

or

set a different ringtone for each connection:

- ▶ Select ringtones for the various events from the lists ▶ click on **Play** ... the melody selected is played ▶ **Set**

Different ringtones can be used for the following events: **External calls, Internal calls, Group calls**



Setting ringtones using the display menu: → p. 29

### Loading ringtones from the PC

The ringtones available are displayed with a file name and size. A maximum of 20 more ringtones can be loaded into the telephone memory from the PC.

The data on the PC must be in the following format:

| Format        | Max. number | Total size |
|---------------|-------------|------------|
| mp3, ogg, wav | 20          | max. 5 MB  |

- ▶ Next to the **Ringtone file** click on **Browse** ▶ in the file system of the PC navigate to the location of the ringtone files in the memory and select the file required ... the file name is displayed

Load the ringtone file: ▶ Click on  ... the ringtone file is loaded into the telephone's internal memory and presented for selection in the lists

Delete a ringtone file: ▶ Click on  ... the ringtone file is deleted from the list

Save the settings: ▶ **Set**



Check available space in the memory: → p. 42

### Settings for the display

Tailor the telephone display to personal preferences and requirements.

#### ▶ Settings ▶ Desk Phone ▶ Display

- Language: ▶ Select the language to be used for the display from the **Language** list
- Screensaver: ▶ Activate/deactivate the screensaver ( = activated; in idle status, a screensaver is shown on the display)  
Setting the screensaver with the display menu: → p. 30
- Colour scheme: ▶ Select the colour scheme for the display from the Colour scheme list (**White on Black, White on Blue, White on Red or White on Green**)
- Illumination: ▶ Select the intensity of the display illumination from the **Backlight** list (1 – 9; 1 = dark, 9 = light)
- Contrast: ▶ Select the screen contrast from the **Contrast** list (1 – 9)
- Save the settings: ▶ **Set**



All the settings can also be made through the display menu: → p. 30

### Setting the screensaver

The default screensaver is an analogue clock.

- ▶ Select from the **Screensaver** list the screensaver you want (**Analog clock, Digital clock**)

Save the settings: ▶ **Set**



Setting the screen saver using the display menu: → p. 30

### Assigning values to function keys

Assigning values to function keys (→ p. 8)

#### ▶ Settings ▶ Desk Phone ▶ Keys and LEDs

The table contains an entry for each function key.

|                   |   |
|-------------------|---|
| <b>Key</b>        | Name of the key, identifies the position of the key next to the display   |
| <b>Function</b>   | Function assigned to the key  |
| <b>LED colour</b> | Colour with which the LED on the key signals an event, such as an incoming call.<br>Change the colour: ▶ select the colour required from the list |

#### No auto provisioning

Function keys can automatically be assigned via a PABX. Preventing the key from being overwritten by the PABX:

- ▶ Activate the option ( = activated)

Assigning a function:

- ▶ click on  ▶ select function from the list ▶ **Set**



Possible functions:

- No function**      No function assigned
- Line**              Assigns a specific connection (line) to the function key. The key is used to initiate or accept a call on this connection. The key flashes if a call comes in and lights up if the line is busy.
  - ▶ Select the desired connection
- Quick Dial**      Assigns a number to the function key.
  - ▶ Select connection required ▶ enter **Phone number** ▶ enter name for the function key
- BLF**                The telephone is connected to a PABX which supports this function and the number is assigned to a group.
 

A function key that is configured as BLF (Busy Lamp Field) indicates the status of a shared line. It will be configured on all extensions of the group. The keys will flash on all extensions if a call comes in and light up if the line on any extension is busy.

  - ▶ Select connection required ▶ enter **Phone number** ▶ enter name for the function key

Accept incoming calls: ▶ Enter **Call Pickup Code**
- SIP URI**            Assigns an SIP URI to the function key.
  - ▶ Enter SIP URI (e. g. sip:Susan.Brown@211.122.10.15) ▶ enter name for the function key
- ▶ **Set**

## System settings

---

### Date and time

- ▶ Settings ▶ System ▶ Date and Time

#### Defining the time server

- ▶ **Automatic adjustment of system time with time server:** select **Yes** ▶ in the **Time server** field enter the IP address of the server required ... the most recent synchronisation with the time server is displayed ▶ **Set**

or

#### Entering the date and time manually

- ▶ **Automatic adjustment of system time with time server:** select **No** ... then

- Time and date: ▶ ... set the **Time** with the arrows ⬆️ ⬆️  
06 : 32  
⬆️ ⬆️
  - ▶ ...  open calendar ▶ select **Date**
- Time zone: ▶ Select **Time zone** from the list
- Daylight Saving Time: ▶ **Automatically adjust clock for daylight saving changes:**  
Select **Yes/No**
- Time format: ▶ Select **Time format** from the list:  
**12h** (e. g. 6:00 am) or **24h** (e. g. 18:00)
- Date format: ▶ Select **Date order** from the list:  
**Day Month Year** (e. g. 17.04.2016) or  
**Month Day Year** (e. g. 04.17.2016)
- Save the settings: ▶ **Set**



Setting the time and date with the display menu: ➔ p. 28

---

### Saving and restoring settings

Save data from the telephone to the PC and restore it back to the telephone if necessary.

- ▶ Settings ▶ System ▶ Save and Restore

#### Save Device Settings to PC

- All settings: System settings and personal settings
- Personalised settings: e. g. directory entries, ringtones, display settings, function key assignments

- ▶ click **Save all settings**

or

- ▶ click **Save personalized settings**
- ▶ select a storage location on the PC ▶ save file

## Restore Device Settings from PC

- ▶ Click **Browse** ▶ select the stored back-up file from the file system ... the file is displayed ▶ click  ... the file is loaded; a message indicates whether the loading process has been successful or not ▶ confirm the message with **OK**

Deleting unwanted back-up files: ▶ click 

---

## Rebooting or resetting the system

- ▶ **Settings** ▶ **System** ▶ **Reboot and Reset**

Restart the system: ▶ Click **Reboot system now** ▶ confirm prompt with **Yes** ... the telephone is rebooted and temporarily not ready for operation.

Reset the system: ▶ **Reset to factory settings** ▶ Confirm prompt with **Yes** ... all personal settings, lists and directory entries are deleted, passwords are reset.

Once this has been completed, the login screen is displayed again, the telephone is in idle status.



Resetting the device using the display menu: → p. 31

## Status of the telephone

The **Status** menu contains information about the status of the telephone.

---

### Device

The page shows general information about the telephone, such as the IP address, the current status of the firmware and the time and date settings.

▶ **Status** ▶ **Device**

---

### Connections

The page shows information about the VoIP connections configured for the telephone.

▶ **Status** ▶ **Connections** . . . name and status are shown for each connection

|               |                       |   |
|---------------|-----------------------|---|
| <b>Status</b> | <b>Registered</b>     | VoIP connection available.  |
|               | <b>Not registered</b> | Currently there is no VoIP connection assigned. The telephone cannot be used.<br>▶ Please contact the administrator |

The **Default send connection** is marked with ✓.

Changing the standard send connection: → p. 35

---

### Storage Allocation

The page shows the memory space occupied by the internal memory and how much is still available (in percent). Files are stored in the internal memory, for example.

▶ **Status** ▶ **Storage Allocation**

# Appendix

---

## Service (Customer Care)

Do you have any questions? For quick assistance, please refer to this user guide or visit [gigasetpro.com](http://gigasetpro.com). Our Gigaset pro reseller will be happy to help with any further questions related to your Gigaset Maxwell basic PRO.

---

## Manufacturer's advice

---

### Authorisation

Voice over IP telephony is possible via the LAN interface (IEEE 802.3).

Depending on your telecommunication network interface, an additional modem could be necessary.

For further information please contact your Internet provider.

This device is intended for use worldwide. Use outside the European Economic Area (with the exception of Switzerland) is subject to national approval.

Country-specific requirements have been taken into consideration.

We, Gigaset Communications GmbH, declare that this device meets the essential requirements and other relevant regulations laid down in Directive 1999/5/EC.

The EC declaration of your country according to 1999/5/EC can be found at:

[www.gigaset.com/docs](http://www.gigaset.com/docs).

This declaration could also be available in the "International Declarations of Conformity" or "European Declarations of Conformity" files.

Therefore please check all of these files.

**CE 0682**

---

## Environment

---

### Our environmental statement

We at Gigaset Communications GmbH are aware of our social responsibility. That is why we actively take steps to create a better world. In all areas of our business – from product planning and production to sales and waste of disposal – following our environmental conscience in everything we do is of utmost importance to us.

Learn more about our earth-friendly products and processes online at [www.gigaset.com](http://www.gigaset.com).

---

## Environmental management system



Gigaset Communications GmbH is certified pursuant to the international standards ISO 14001 and ISO 9001.

**ISO 14001 (Environment):** Certified since September 2007 by TÜV SÜD Management Service GmbH.

**ISO 9001 (Quality):** Certified since 17/02/1994 by TÜV SÜD Management Service GmbH.

---

## Disposal

Batteries should not be disposed of in general household waste. Observe the local waste disposal regulations, details of which can be obtained from your local authority.

All electrical and electronic products should be disposed of separately from the municipal waste stream via designated collection facilities appointed by the government or the local authorities.



This crossed-out wheeled bin symbol on the product means the product is covered by the European Directive 2002/96/EC.

The correct disposal and separate collection of your old appliance will help prevent potential negative consequences for the environment and human health. It is a pre-condition for reuse and recycling of used electrical and electronic equipment.

For more detailed information about disposal of your old appliance, please contact your local council refuse centre or the original supplier of the product.

## Care

Wipe the device with a **damp** cloth or an antistatic cloth. Do not use solvents or microfibre cloths.

**Never** use a dry cloth; this can cause static.

In rare cases, contact with chemical substances can cause changes to the device's exterior. Due to the wide variety of chemical products available on the market, it was not possible to test all substances.

Impairments in high-gloss finishes can be carefully removed using display polishes for mobile phones.

---

## Contact with liquid

If the device comes into contact with liquid:

- 1 **Disconnect the power supply.**
- 2 Allow the liquid to drain from the device.
- 3 Pat all parts dry.
- 4 Place the device in a dry, warm place **for at least 72 hours** (**not** in a microwave, oven etc.) with the battery compartment open and the keypad facing down (if applicable).
- 5 **Do not switch on the device again until it is completely dry.**

When it has fully dried out, you will normally be able to use it again.

## Menu tree

The following illustration shows the full menu tree of the display menu.





|                 |                      |                |                          |                |         |
|-----------------|----------------------|----------------|--------------------------|----------------|---------|
| Contacts        | Directory            |                |                          |                | → p. 24 |
|                 | Enterprise directory |                |                          |                | → p. 26 |
| Select Services | Call Divert          |                |                          |                | → p. 19 |
|                 | Withhold Number      |                |                          |                | → p. 14 |
|                 | Call Waiting         |                |                          |                | → p. 17 |
|                 | Active Ringbacks     |                |                          |                | → p. 13 |
| Settings        | Date + Time          |                |                          |                | → p. 28 |
|                 | Audio Settings       | Ringtones      | Volume                   |                | → p. 29 |
|                 |                      |                | Melodies                 | External Calls | → p. 29 |
|                 |                      |                |                          | Internal Calls | → p. 29 |
|                 |                      |                |                          | Group Calls    | → p. 29 |
|                 |                      |                | Anonymous Call Silencing |                | → p. 29 |
|                 |                      | Advisory Tones |                          |                | → p. 30 |
|                 | Display              | Screensaver    |                          |                | → p. 30 |
|                 |                      | Brightness     |                          |                | → p. 30 |
|                 |                      | Colour Scheme  |                          |                | → p. 31 |
|                 | Language             |                |                          |                | → p. 31 |
|                 | Local Network        |                |                          |                | → p. 31 |
|                 | Reset                |                |                          |                | → p. 32 |
|                 | Info                 |                |                          |                | → p. 32 |







## Display icons

The following icons are displayed depending on the settings and the operating status of your telephone.





### Icons in the status bar

| Icon   | Meaning  |
|--|--|
|  | No VoIP connection                             |
|  | USB device connected                           |
|  | Keypad lock activated                          |
|  | Ringtone deactivated                           |
|  | Beep function activated (ringtone deactivated) |

### Display icons to indicate ...

| Icon   | Meaning   |
|--|---|
|  | Incoming call                                   |
|  | Establishing a connection (outgoing call)       |
|  | Connection established                          |
|  | No connection established/connection terminated |
|  | Conference established                          |

### Other display icons

| Icon   | Meaning                 |
|--|-------------------------|
|  | Action complete (green) |
|  | Action failed (red)     |
|  | Information             |
|  | Warning                 |
|  | (Security) prompt       |

# Index

- 
- A**
- Accepted calls . . . . . 20
  - Advisory tone
    - confirmation . . . . . 30
    - key press . . . . . 30
  - Alert tone (beep) . . . . . 15
  - Analogue clock as the screensaver . . . . . 30
  - Anonymous calling . . . . . 14
  - Authorisation . . . . . 43
- 
- B**
- Back key . . . . . 3
  - Beep (alert tone) . . . . . 15
  - Black list . . . . . 36
  - BLF (Busy Lamp Field) . . . . . 39
- 
- C**
- Call
- accept . . . . . 14
  - anonymous . . . . . 14
  - block . . . . . 36
  - during number entry . . . . . 12
  - forwarding . . . . . 19
  - in call list . . . . . 20
  - incoming . . . . . 14
  - information . . . . . 20
  - initiate . . . . . 12
  - outgoing . . . . . 12
  - rejecting . . . . . 14
- Call divert
- deactivate . . . . . 19
  - set up (display menu) . . . . . 19
  - set up (Web configurator) . . . . . 36
- Call list . . . . . 20
- accepted calls . . . . . 20
  - all calls . . . . . 20
  - copying a number to the directory . . . . . 21
  - delete . . . . . 21
  - delete an entry . . . . . 21
  - dialling a number . . . . . 13, 20
  - missed calls . . . . . 20
  - open . . . . . 20
  - outgoing calls . . . . . 20
- Call swapping . . . . . 18
- Call waiting . . . . . 18
- accepting a call . . . . . 17
  - activating/deactivating . . . . . 17
  - rejecting a call . . . . . 17
  - settings (Web configurator) . . . . . 35
- Caller
- name on display . . . . . 14
  - picture on display . . . . . 14
- Caller display . . . . . 14
- Caller picture . . . . . 14
- Care . . . . . 45
- Care of the device . . . . . 45
  - Change telephone PIN . . . . . 33
  - Change the volume . . . . . 16
  - Colour scheme
    - set (display menu) . . . . . 31
    - set (Web configurator) . . . . . 38
  - Company directory . . . . . 26
    - displaying an entry . . . . . 27
    - open . . . . . 26
  - Conference call . . . . . 18
  - Conference call key . . . . . 3
  - Confirmation tone . . . . . 30
  - Connection . . . . . 35
    - expansion module . . . . . 4
    - headset . . . . . 4
    - LAN . . . . . 4
    - PC . . . . . 4
    - power adapter . . . . . 4
    - receiver . . . . . 4
    - status . . . . . 42
    - USB . . . . . 4
  - Consultation call . . . . . 17
  - Consultation call key . . . . . 3, 17
  - Contact with liquid . . . . . 45
  - Contrast
    - set (Web configurator) . . . . . 38
  - Control key . . . . . 3, 9
  - Conversation
    - put on hold . . . . . 17
  - Copying a number
    - from the call list to the directory . . . . . 21
  - Corporate directory
    - searching for entry . . . . . 27
  - Correcting incorrect entries . . . . . 11
  - Correction of incorrect entries . . . . . 11
  - Country version . . . . . 32
  - Customer Care . . . . . 43
- 
- D**
- Date format . . . . . 28, 40
  - Daylight Saving Time . . . . . 40
  - Deactivating the microphone . . . . . 16
  - Default setting see Factory settings
  - Delete numbers . . . . . 12
  - Device, status . . . . . 42
  - Dialling a number
    - from the call list . . . . . 13, 20
    - from the company directory . . . . . 27
    - from the directory . . . . . 13, 26
    - from the redial list . . . . . 13
    - via function key . . . . . 13
    - via the keypad . . . . . 12
  - Dialling numbers
    - cancelling . . . . . 12
  - Digital clock as the screensaver . . . . . 30
  - Directories . . . . . 24

|  |      |
|--|------|
| Directory entry                                  | 25   |
| change   | 25   |
| delete   | 26   |
| in the corporate directory                       | 27   |
| new  | 25   |
| Directory, local                                 |      |
| changing an entry                                | 25   |
| copying a number from the call list              | 21   |
| delete   | 26   |
| delete entry                                     | 26   |
| display entry                                    | 25   |
| new entry  | 25   |
| open   | 24   |
| Display  | 7    |
| caller display                                   | 14   |
| contrast   | 38   |
| menu tree  | 46   |
| returning to idle status                         | 10   |
| Display icons                                    | 47   |
| Display illumination                             |      |
| set brightness (display menu)                    | 30   |
| set brightness (Web configurator)                | 38   |
| Display keys                                     | 2, 7 |
| Display MAC address                              | 32   |
| Display menu                                     | 46   |
| Disposal   | 44   |
| DND (Do Not Disturb) see Silencing the telephone |      |
| Do not disturb                                   | 15   |
| Do not disturb (DND)                             | 36   |
| Do Not Disturb key                               | 3    |
| LED  | 3    |
| Do not disturb key                               | 15   |

## E

|                              |    |
|------------------------------|----|
| End key                      | 3  |
| Ending                       |    |
| a call                       | 16 |
| Entering letters             | 11 |
| Entering numbers             | 11 |
| Entering text                | 11 |
| Environment                  | 43 |
| Error tone                   | 30 |
| Expansion module, connection | 4  |

## F

|                   |        |
|-------------------|--------|
| Factory settings  | 32     |
| Firmware version  | 32, 42 |
| Forwarding a call | 19     |
| Function key      | 13     |
| BLF               | 39     |
| connection        | 39     |
| quick dial        | 39     |
| Function keys     | 3, 8   |

## H

|                     |       |
|---------------------|-------|
| Handset             |       |
| changing volume     | 16    |
| Handsfree           |       |
| switching on/off    | 16    |
| Handsfree key       | 3, 16 |
| LED                 | 3     |
| Handsfree mode      | 12    |
| changing volume     | 16    |
| Hash key            | 2     |
| Headset             |       |
| changing volume     | 16    |
| using to make calls | 12    |
| Headset connection  | 4     |
| Headset key         | 3     |
| LED                 | 3     |

## I

|                                  |    |
|----------------------------------|----|
| Icons                            |    |
| indications                      | 47 |
| status bar                       | 47 |
| Idle status, returning to        | 10 |
| Indications, icons               | 47 |
| Information on the telephone     | 32 |
| Initiate consultation call       |    |
| from the directory               | 18 |
| IP address                       | 32 |
| finding via the display          | 33 |
| finding via the Web configurator | 42 |
| obtaining automatically          | 31 |
| static                           | 31 |

## K

|                   |       |
|-------------------|-------|
| Key               |       |
| conference call   | 3     |
| consultation call | 3, 17 |
| control key       | 3     |
| display           | 2     |
| do not disturb    | 3, 15 |
| end/back          | 3     |
| handsfree         | 16    |
| handsfree mode    | 3     |
| hash              | 2     |
| headset           | 3     |
| message           | 22    |
| message centre    | 3     |
| mute              | 3     |
| programmable      | 3     |
| star              | 2     |
| volume            | 2, 16 |
| Keypad            |       |
| locking/unlocking | 11    |
| Keypad lock       |       |
| changing the PIN  | 33    |
| PIN               | 11    |

## Index

- 
- L**
- LAN connection . . . . . 4
  - Language for the display screen
    - setting (display menu) . . . . . 31
    - setting (Web configurator) . . . . . 38
  - LED
    - do not disturb key . . . . . 3
    - handsfree key . . . . . 3
    - headset key . . . . . 3
    - message key . . . . . 3
    - mute key . . . . . 3
  - Line
    - selecting for call . . . . . 12
  - Liquid . . . . . 45
- 
- M**
- Main menu . . . . . 10
  - Making calls . . . . . 12
  - Manufacturer's advice . . . . . 43
  - Medical equipment . . . . . 6
  - Menu . . . . . 10
    - navigation . . . . . 9, 10
    - open . . . . . 10
  - Menu tree
    - display . . . . . 46
    - web configurator . . . . . 34
  - Message Centre . . . . . 22
  - Message key . . . . . 3, 22
    - LED . . . . . 3
  - Missed calls . . . . . 20
  - Mute key . . . . . 3
    - LED . . . . . 3
  - Muting . . . . . 16
- 
- N**
- Number
    - copying from voice mail to the directory . . . . . 23
    - showing on display . . . . . 14
    - transferring to the local directory . . . . . 12
- 
- O**
- Open listening . . . . . 16
- 
- P**
- PC connection . . . . . 4
  - Phone
    - factory settings . . . . . 41
    - rebooting . . . . . 41
  - Power adapter, connection . . . . . 4
  - Put on hold . . . . . 17
- 
- Q**
- Quick dial . . . . . 39
- 
- R**
- Receiver
    - connection . . . . . 4
  - Redial list . . . . . 20
    - dialling a number . . . . . 13
  - Reset . . . . . 41
  - Restart . . . . . 41
  - Restore factory settings
    - using the device keys . . . . . 32
    - using the display menu . . . . . 32
    - using the Web configurator . . . . . 41
  - Ringback
    - cancelling . . . . . 14
    - initiate . . . . . 13
  - Ringtone
    - activating/deactivating . . . . . 15
    - delete . . . . . 37
    - load . . . . . 37
    - set using the display menu . . . . . 29
    - set using the Web configurator . . . . . 37
    - setting the melody . . . . . 29
    - standard . . . . . 37
    - volume for incoming calls . . . . . 29
- 
- S**
- Safety precautions . . . . . 6
  - Screensaver
    - activate/deactivate (display menu) . . . . . 30
    - activate/deactivate (Web configurator) . . . . . 38
    - set up . . . . . 30
  - Service . . . . . 43
  - Setting language
    - for Web configurator . . . . . 33
  - Setting the date
    - display menu . . . . . 28
    - web configurator . . . . . 40
  - Setting the language for the Web configurator . . . . . 33
  - Setting the time
    - display menu . . . . . 28
    - web configurator . . . . . 40
  - Silencing the telephone . . . . . 15
  - Specifying the time zone . . . . . 40
  - Split line
    - assigning function key . . . . . 39
  - Standard ringtone . . . . . 37
  - Standard send connection . . . . . 12
    - change . . . . . 35
    - display . . . . . 42
  - Star key . . . . . 2
  - Status . . . . . 42
    - connections . . . . . 42
    - device . . . . . 42
    - memory assignment . . . . . 42
  - Status bar . . . . . 7
    - icons . . . . . 47
  - Storage allocation . . . . . 42
  - Submenu . . . . . 10
  - SW version see Firmware version

|  |        |
|--|--------|
| System settings                            |        |
| date and time . . . . .                    | 40     |
| saving/restoring . . . . .                 | 40     |
| <hr/>                                      |        |
| <b>T</b>                                   |        |
| Telephone                                  |        |
| connections . . . . .                      | 4      |
| keys . . . . .                             | 2      |
| Telephone settings                         |        |
| in display menu. . . . .                   | 28     |
| in the Web configurator . . . . .          | 33     |
| Time format . . . . .                      | 28, 40 |
| Time server . . . . .                      | 28, 42 |
| defining . . . . .                         | 40     |
| <hr/>                                      |        |
| <b>U</b>                                   |        |
| USB connection socket . . . . .            | 4      |
| <hr/>                                      |        |
| <b>V</b>                                   |        |
| Voice mail . . . . .                       | 23     |
| delete . . . . .                           | 23     |
| playing . . . . .                          | 23     |
| transferring number to directory . . . . . | 23     |
| VoIP connection . . . . .                  | 12, 35 |
| Volume for ringtone . . . . .              | 29     |
| Volume key . . . . .                       | 2, 16  |
| <hr/>                                      |        |
| <b>W</b>                                   |        |
| Web configurator                           |        |
| accessing . . . . .                        | 33     |
| changing password . . . . .                | 33     |
| de-registration . . . . .                  | 33     |
| menu structure (users) . . . . .           | 34     |
| selecting language . . . . .               | 33     |
| settings . . . . .                         | 33     |
| starting . . . . .                         | 33     |

Issued by

Gigaset Communications GmbH  
Frankenstr. 2a, 46395 Bocholt

© Gigaset Communications GmbH 2016

Subject to availability.

All rights reserved. Rights of modifications reserved.

[www.gigasetpro.com](http://www.gigasetpro.com)