

**Gigaset**pro

# N870 IP PRO

## Multicell System

Site Planning and Measurement Guide

BECAUSE IT'S YOUR BUSINESS.

---

# Table of Contents

<b>Planning a DECT multicell network</b> .....	<b>3</b>
Components of N870 IP PRO .....	3
N870 IP PRO installations .....	5
Cluster forming .....	7
Criteria for an optimum DECT wireless network .....	9
Overlapping and synchronising .....	12
Synchronisation planning .....	13
<b>Projecting the DECT network</b> .....	<b>25</b>
Determining the requirements for the telephone network .....	25
Conditions for the positioning of the base stations .....	26
Preliminary identification of the positions of the base stations .....	35
<b>Taking measurements</b> .....	<b>38</b>
Defining thresholds .....	39
Measuring the wireless range of the planned base stations .....	41
Evaluating measurements .....	45
<b>DECT installations in special environments</b> .....	<b>47</b>
<b>Index</b> .....	<b>49</b>

## Planning a DECT multicell network

This document explains the preparations necessary to install a multi-cell DECT network and take measurements for the optimum positioning of the base stations. It also provides technical and practical background information.

### Components of N870 IP PRO

N870 IP PRO is a DECT multi-cell system for connecting DECT base stations to a VoIP PBX. It combines the options of IP telephony with the use of DECT telephones.

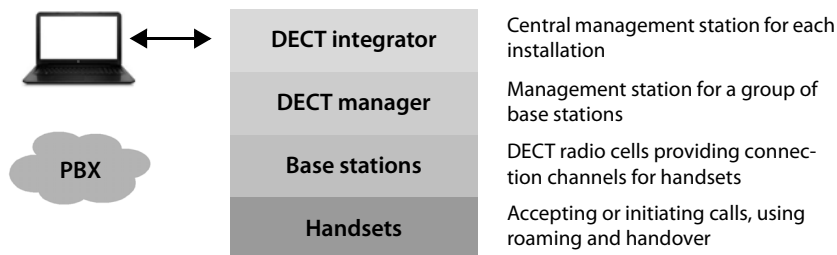

#### DECT integrator

Central management and configuration unit of the DECT multi-cell system.

The DECT integrator

- contains the central database for the DECT subscribers and base stations
- provides a web interface for configuring the entire cordless system
- enables access for configuration of all DECT managers and their base stations

#### DECT manager

Management station for a group of base stations. At least one DECT manager must be used in every installation.

The DECT manager

- manages synchronisation of the base stations within clusters
- acts as an application gateway between SIP and DECT signalling
- controls the media path from the phone system to the relevant base stations

#### DECT base stations

- form the wireless cells of the DECT phone network
- provide media processing from the handsets directly to the phone system
- make available connection channels for the handsets (the number is dependent on various factors, such as bandwidth approved)  
(refer to Section **Capacity** → p. 10)

## Planning a DECT multicell network

### Gigaset handsets

- Many handsets are connected per DECT manager and many DECT calls can be held simultaneously (VoIP calls, and phone book or Info Centre accesses). Information on the functions of certain handsets on Gigaset base stations is available from [wiki.gigasetpro.com](http://wiki.gigasetpro.com).
- Subscribers can accept or initiate calls in all DECT cells with their handset (**Roaming**), and can also switch between the DECT cells during a call (**Handover**). A handover is only possible when the cells are synchronised.

### Phone system

Connect your DECT phone system to a VoIP phone system, e.g.:

- your own PABX (on-premise solution)
- a virtual phone system from an external provider (Cloud solution, hosted PBX)
- VoIP provider

The phone system

- establishes the connection to a public phone network
- enables central management of phone connections, directories, network mailboxes, . . .

## N870 IP PRO installations

Different build levels of the N870 IP PRO can be installed.

### Small an medium installations

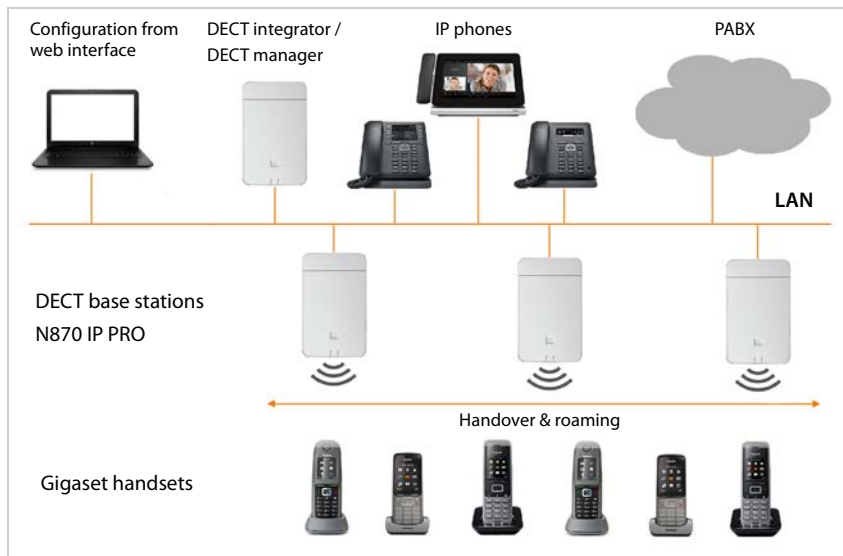

### Small installations

- Integrator, DECT manager and a base station are together at the same device.
- Up to 9 further base stations can be managed.
- Up to 50 handsets can be registered.

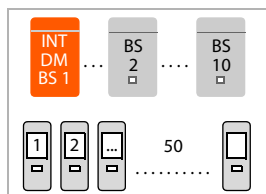

### Medium installations

- Integrator and DECT manager are together at the same device. No base station is enabled at this device.
- Up to 60 base stations can be managed.
- Up to 250 handsets can be registered.

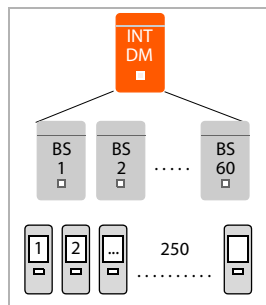

## Large installations

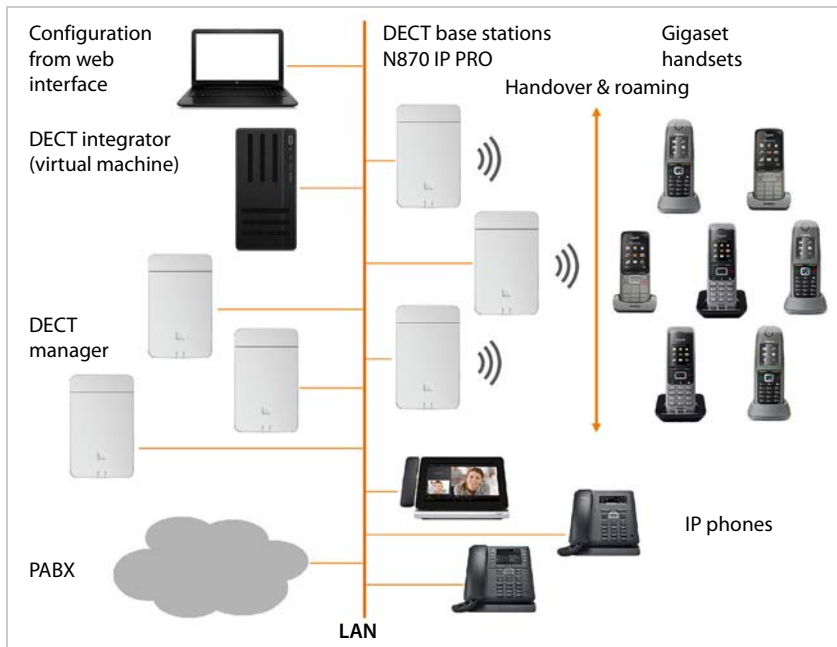

In a large installation the integrator is available as an own system component. An integrator is needed when:

- the system comprises more than 250 handsets
- you need more then 60 DECT base stations
- you want to manage more than one DECT manager via one web-interface
- you want to roam with the DECT handsets between multiple DECT managers/locations

### Virtual integrator

- The integrator is available on a virtual machine.
- Up to 100 DECT managers can be used.
- Per DECT manager up to 60 base stations can be managed, 6000 in total.
- Up to 20000 handsets can be registered.

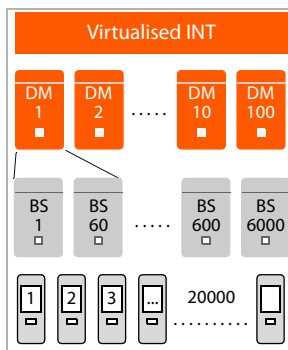

### Device role: Integrator only

- The integrator is located alone at a device. No DECT manager or base station is enabled at this device.
- Up to 4 DECT managers can be used.
- Each DECT manager can manage up to 60 base stations, up to 240 base stations can be managed in total.
- Up to 800 handsets can be registered.

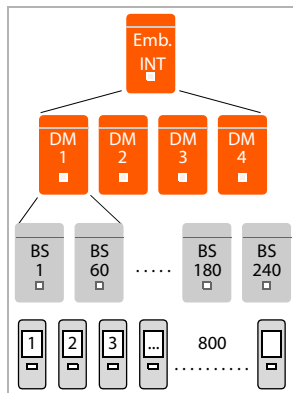

For further information on the options provided by the N870 IP PRO, and about installing, configuring and operating the Gigaset devices mentioned, see the relevant user guide. These are provided on [wiki.gigasetpro.com](http://wiki.gigasetpro.com).

## Cluster forming

A cluster comprises a number of base stations of a DECT manager that synchronise with each other to enable handover, roaming and load balancing.

**Handover:** The DECT connection of a handset is passed to another base station during a call.

**Roaming:** A handset in idle mode is connected to the system via a new base station.

**Overload balancing:** Is the process to setup a DECT connection (for a call or other administrative or customer purpose) not at the current base station, which is fully loaded with active DECT or media connections, but via neighbour base station, which has free resources to setup/accept the new DECT connection. While handover and roaming is possible between base stations of different DECT managers, overload balancing is only possible inside the area of one DECT manager.

Handovers and load balancing can only be realised by base stations that are synchronised with each other .

A DECT manager usually manages one cluster.

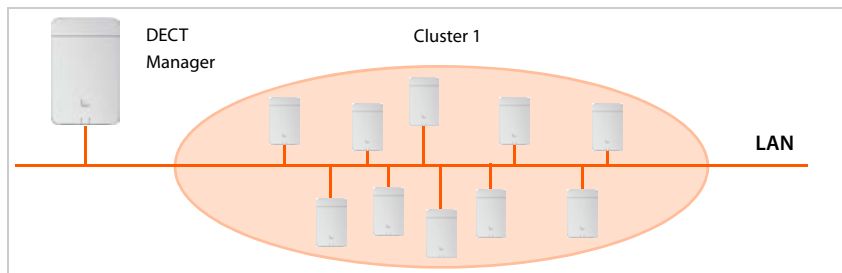

## Planning a DECT multicell network

The DECT manager is connected to the base stations and the PABX via the local network and is therefore not dependent on DECT ranges. Base stations that are far apart can be grouped into different clusters if synchronisation is barely, or not, possible, and is not required. All the base stations of a DECT manager must belong to the same LAN subnet of the DECT manager.

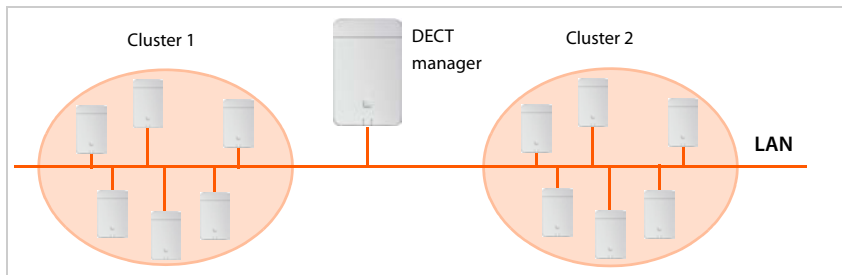

## Large installations

For installations in different LAN subnets, multiple DECT managers with one DECT manager per subnet are required. The DECT manager function can be installed in parallel on the same device (depending on the capacity of the local base station). Multiple DECT managers are also required when the requirement is to connect more than 250 handsets or provide more than 60 connection channels.

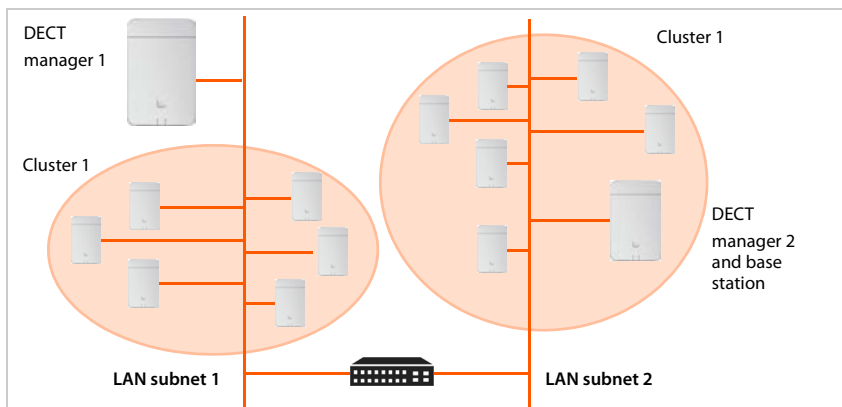

In installations with multiple DECT managers, handover and roaming between base stations of different DECT managers are possible when the clusters are synchronised. Load balancing of attached handset from fully handset loaded DECT manager to alternative DECT manager is not possible.

For more information on this, refer to Section **Large installations: Using multiple DECT managers** → p. 27.



## Criteria for an optimum DECT wireless network

A carefully planned DECT wireless network with adequate coverage is the prerequisite for operating a telephone system that offers good call quality and sufficient call options for all subscribers in all buildings and areas belonging to the PABX.

It is difficult to assess the technical wireless conditions of a DECT installation in advance as they are influenced by many environmental factors. Therefore, the specific circumstances on-site must be determined by taking measurements. This leads to a reliable conclusion about the material required as well as the locations of the wireless units.

Various aspects need to be taken into consideration when planning a DECT wireless network. The following requirements must be considered when deciding how many base stations are required and where they should be placed:

- Sufficient DECT wireless coverage of the entire site so that every subscriber can be reached.
- Sufficient wireless channels (DECT bandwidth), in particular in "hotspots", to avoid capacity bottlenecks.
- Sufficient overlap of cells to enable synchronisation of the base stations and to guarantee freedom of movement for subscribers when making calls.

## Wireless coverage

The selection of locations where the base stations are to be installed should guarantee optimum wireless coverage and enable cost-effective wiring.

Optimum wireless coverage is achieved if the required reception quality is delivered at all points of the wireless network. If costs need to be considered, this should be done with a minimum number of DECT base stations.

To ensure an interference-free switch of call connections from one cell to another (handover), there must be an area where good reception is ensured for both base stations. To achieve this, a minimum quality for reception must be defined.

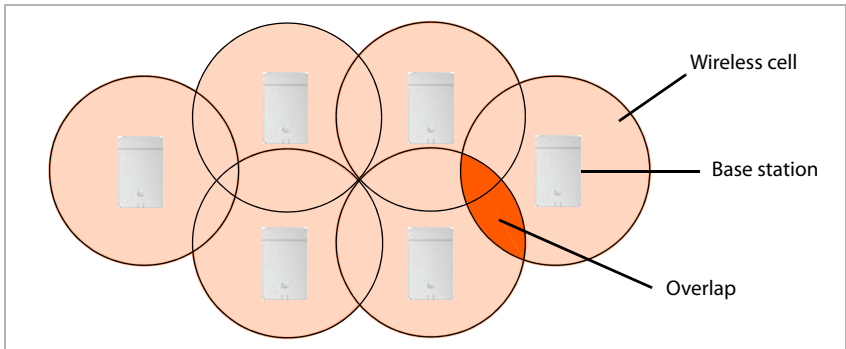

## Planning a DECT multicell network

### Signal transmission

The ideal signal transmission of a base station is shaped like a ring, i.e., so that the registered handsets can be the same distance away from the base station in all directions without the wireless signal being interrupted.

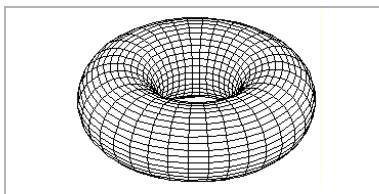

The range is actually influenced by a variety of environmental conditions. For example, obstacles such as walls or metal doors can impede the wireless signals or interfere with their uniform transmission.

You should investigate the actual conditions that the planned wireless network will be subjected to by measuring the signal transmission of the measuring base station at appropriate positions.

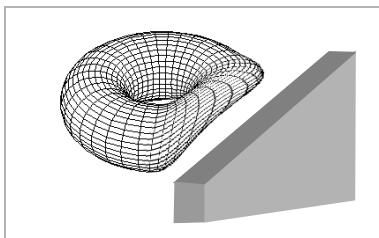

### Capacity

The capacity of the cells must be high enough to guarantee that the subscribers can be reached in high-density traffic. A cell is at full capacity when the number of connections required for each base station is higher than the number of possible connections.

On the one hand, the number of parallel connections possible is dependent on the approved codecs that can be used for the connections. Which codecs are approved can be set from the web interface. The device function also has a bearing on capacity. A N870 IP PRO Multicell System device can only be deployed as a base station, a DECT manager with base station, or an integrator with DECT manager and base station. Also note that a DECT manager can manage a maximum of 60 connection channels in parallel.

The following table shows the maximum number of possible connections in relation to the device function and approved codecs.

Approved codecs	Only BS	BS + DM	Base + DM + INT
G.711 only	10	8	5
G.729 and G.711	8	5	5
G.722 and G.729 and G.711	5	5	5



When the system is first delivered, all codecs are approved in the configuration. Broadband codec G.722 needs to be enabled explicitly however.

There are two options for increasing capacity:

- Reducing the distance between the base stations.

This means that the cells overlap more, giving the subscriber access to the base stations of the neighbouring cells. This results in more even wireless quality. However, this can result in considerable installation costs for an existing system.

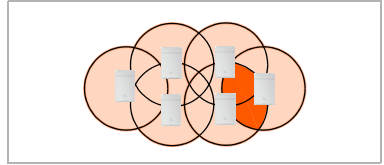

- Installing parallel base stations.

The cell size remains generally constant but the number of possible connections increases. Installing the base stations close to one another means that the additional assembly costs are low. A minimum distance between base stations must be observed however (→ **Technical conditions**, p. 27).

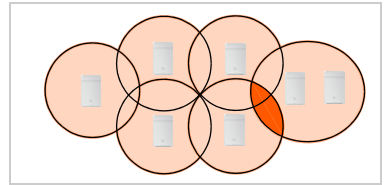

To keep the costs low for the devices, and for installation and maintenance, the typical requirement is to keep the number of base stations as low as possible. Despite this, as much as necessary needs to be planned to safeguard capacity and wireless coverage.



If entire call capacity at single base station is busy, handsets load balance to free capacity on neighboured base stations. Density of base stations must be planned to provide sufficient call capacity in any given area. In areas where high traffic volumes are expected, e.g. install a second base station.

## Overlapping and synchronising

For interference-free cooperation in a multi-cell DECT network, the base stations must synchronise. In order to synchronise the base stations and ensure a smooth handover, the cells must overlap.

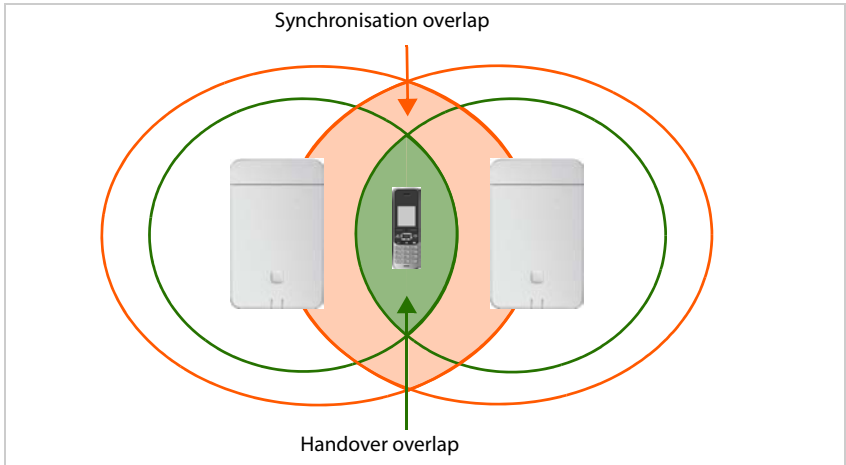

A sufficiently high number of overlapping zones between neighbouring cells must be ensured.

- For synchronisation, neighbouring cells must mutually receive DECT signals having continually good quality.
- For a handover, a handset must have a connection of sufficient quality to both base stations.

Information on the values required is in Section **Defining thresholds** (→ p. 39).

The more densely the base stations are installed, the greater the overlap. Here, a compromise must be found between keeping the area relatively open and installing the lowest possible number of base stations.

The conditions for synchronisation overlap require a shorter distance between the base stations than for a handover. However, the strict requirements are only relevant for base stations along the synchronisation path. Neighbouring base stations that do not synchronise directly with each other can be installed further away from each other.

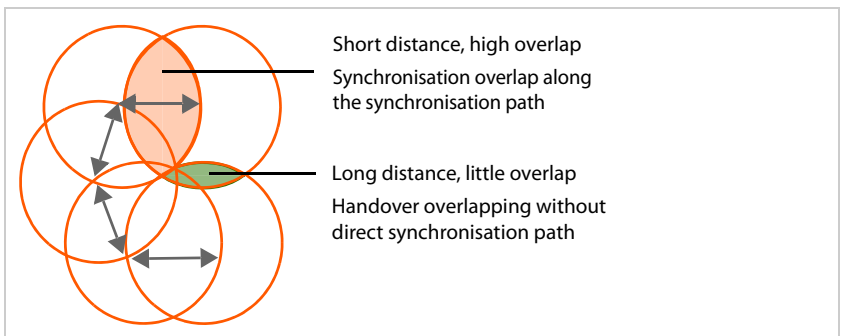

To keep the synchronisation hierarchy flexible (e.g. when the requirement is to optimise synchronisation paths after installation, or to use redundant synchronisation paths), planning short distances for only one synchronisation path is not recommended. The recommendation from actual applications is the pragmatic solution of planning distances such that DECT synchronisation is possible between most neighbouring base stations. This is of course also dependent on the ambient conditions. Thick concrete ceilings or walls would not permit direct DECT synchronisation for example.

### Necessary overlapping for LAN synchronisation

When the connection quality is not high enough in certain areas, base stations can also be synchronised over LAN. Between base stations synchronised over cable, the distances can be greater and the overlapping zones smaller. However, it is not possible either between these base stations to increase the distance to a minimum handover overlap. So that no signal overlaps of two base stations occur on the handsets, base stations must always detect the channels that neighbouring base stations are assigned in the process of dynamic channel assignment.

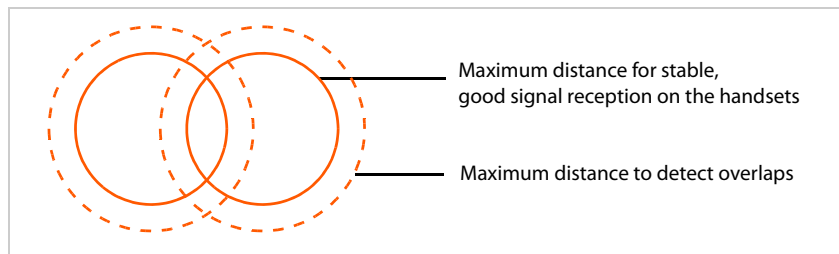

More information on LAN synchronisation is in operating instructions "N870 IP PRO – Installation, Configuration and Operation"

## Synchronisation planning

Base stations that combine to form a DECT wireless network must synchronise with one another to ensure a smooth transition of the handsets from cell to cell (handover). No handover and no (overload) balancing is possible between cells that are not synchronised. In the event of loss of synchronisation, the base station stops accepting calls once all ongoing calls that were being conducted on the asynchronous base station have ended and then it re-synchronises the asynchronous base station.

Base stations can be synchronised "over the air", meaning that they are synchronised via DECT. If the DECT connection between specific base stations seems to be not reliable enough, synchronisation can also take place via LAN. To carry out the synchronisation planning you will need the plan of the clusters with the synchronisation level for each base station.

The synchronisation within a cluster takes place in a master/slave procedure. This means that one base station (sync master) defines the synchronisation cycle for one or more additional base stations (sync slaves).

The synchronisation needs some kind of synchronisation hierarchy with the following criteria:

- 1 There must be one single and common root source for the synchronisation in the hierarchy (sync level 1).
- 2 With synchronisation over LAN there are just two levels needed (LAN-Master and LAN-Slave).
- 3 DECT synchronisation usually needs more than two levels and just one hop, because most base stations won't be able to receive the DECT signal from the root source of the synchroni-

## Planning a DECT multicell network

sation (sync level 1). DECT signal providing reference timer synchronisation is relayed along a chain of multiple base stations, until it finally synchronises the last base station in a sync chain.

- 4 The number of hops along any branch of DECT synchronisation tree should be minimised, because any hop can introduce jitter in the synchronisation timer and could so lower the quality of the synchronisation.

---

### DECT-based synchronisation

To relay DECT synchronisation signals from base station A to base station B, base station B must be able to receive signals from base station A with sufficient signal quality.

This means that the signal strength between neighbouring base stations must be sufficient for synchronisation. The guide value is a minimum of  $-65$  dBm, but this can also be influenced by environmental conditions. For further information on this, refer to Section **Defining thresholds**, → p. 39.



DECT manager and base stations must be connected to the same Ethernet or virtual LAN sharing a common broadcast domain.

A base station can synchronise with each base station on a higher sync level. The sync level concept allows base stations to automatically select the best suitable base station (having a lower sync level number) to receive synchronisation signal from. Simultaneously, it guarantees a strictly limited number of hops along any branch in the synchronisation tree and to prevent circles between automatically optimised synchronisation chains.

During configuration, assign one level in the synchronisation hierarchy (sync level) to each base station. Sync level 1 is the highest level; this is the level of the sync master and appears only once in each cluster. A base station always synchronises itself with a base station that has a better sync level. If it sees several base stations with a better sync level, it synchronises itself with the base station that provides the best signal quality. If it does not see any base station with a higher sync level, it cannot synchronise.

During the synchronisation planning phase, make sure that the distance to the base station with sync level 1 is as short as possible from all sides, i.e., that there are as few levels as possible. It makes sense to select the station that is at the centre of your DECT network as the base station with sync level 1.

Good:

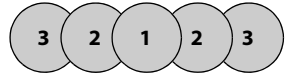

Poor:

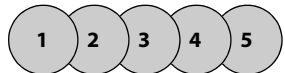

Depending on the topology of your DECT network, your synchronisation hierarchy could look like this, for example.

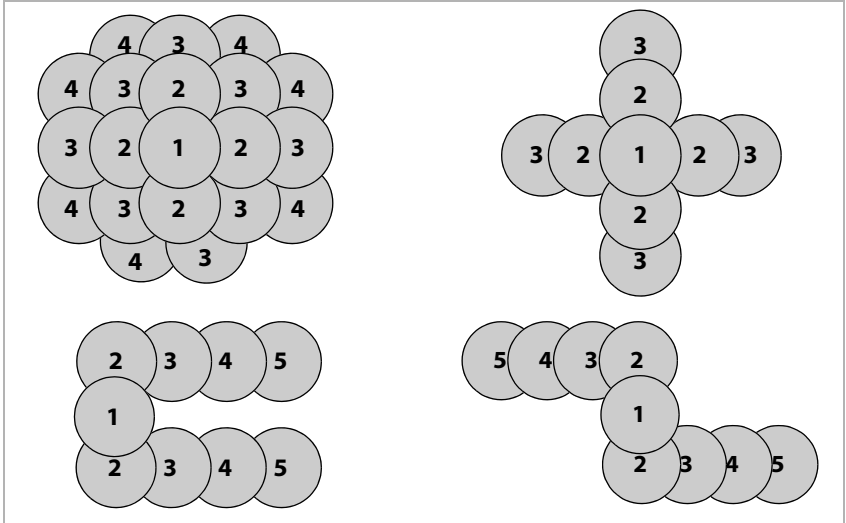

**Summary:** For DECT based synchronisation consider the following rules.

- There can be only one level 1 in a cluster.
- A base station can synchronise with each base station on a higher sync level.
- DECT manager and base stations must be connected to the same Ethernet or virtual LAN sharing a common broadcast domain.
- Minimise the DECT levels as much as possible.
- Sufficient signal quality between base stations is needed (-65dBm) along a synchronisation path.
- For redundancy reasons you may plan for multiple synchronisations paths.

## LAN-based synchronisation along the synchronisation path

If the DECT connection between base stations seems to be not reliable enough to permanently guarantee a stable DECT over the air synchronization, e.g., because they are separated by iron doors or a firewall, you can determine that synchronisation should take place via LAN. In this case the base station with the higher sync level will act as LAN master, the base station with the lower sync level is a LAN slave. One base station must be explicitly be defined as LAN master.

Advantages of LAN synchronisation compared with DECT synchronisation:

- Higher flexibility in the arrangement of the base stations as no synchronisation chains need to be formed.
- Fewer base stations required as the overlapping area of the base stations is smaller. The overlapping area for handset handover can be smaller, because neighboured base stations do not need to receive each other in stable error free quality, but they must still be able to detect each other for the process of dynamic channel selection.

## Planning a DECT multicell network

- Configuration of the system is simplified as all base stations can be synchronised on one synchronisation master.

### Requirements

#### Network requirements:

- The N870 IP PRO devices must be connected to a switch port of minimum 100 Mbit/s with corresponding cabling.
- PoE IEEE 802.3af < 3.8 W (Class 1) for an alternatively external power supply.
- The DECT manager and all its base stations must be in the same layer 2 segment (common broadcast domain).

#### Requirements for LAN synchronisation:

- Minimum number of switch hops between master and all slave base stations.
- For internally and uplink switching use Enterprise class switches  $\geq 1$  Gbit/s.
- VLAN based QoS could be fruitful to minimise packet delay and its jitter. Switch port based VLAN can isolate base stations from other devices' traffic.
- DSCP (Differentiated Services Codepoint) based QoS could be even more efficient.

DSCP tagging:

Sync via LAN: PTPv2, DLS (proprietary): DSCP=CS7=56

RTP: DSCP=EF=46

SIP: DSCP=AF41=34

- Synchronisation via LAN makes intensive use of IP multicasts which have to be supported by the switches.

Multicast destination address and ports:

PTPv2: 224.0.1.129 UDP via ports 319/320

Proprietary DLS protocol: 239.0.0.37 UDP via ports 21045/21046

Cascaded switches might need uplink switching of these multicast packets to allow inter-switch LAN synchronisation. Otherwise you need isolated LAN-sync clusters, inter-cluster-synchronized via DECT.

- IGMP snooping is supported and shall be supported by the switch, to configure and minimise multicast distribution only to the LAN synchronising base stations.

### Packet delay jitter

Minimum packet delay jitter is crucial for successful synchronisation over LAN. As multiple LAN traffic parameters could have an impact on packet delay and its jitter, specific switches and maximum number of switch hops are required, to guarantee sufficient maximum packet delay jitter.

Consider the following:

- The less switch hops, the lower the transmission delay and its jitter will be.
- The higher the bandwidth or quality of used switches is regarding packet delay and its jitter, the lower the packet delay and the lower the packet delay jitter will be.
- Enhanced packet processing logics (like L3 switching or packet inspection) could have significant negative impact on the resulting packet delay jitter. If possible, they should be deactivated for Gigaset N870 IP PRO base stations connected switch ports.



- Significantly increased traffic load on a switch, in the range of the maximum throughput, could have significant negative impact on the packet delay jitter.
- VLAN based prioritisation of LAN packets could be a fruitful measure to minimize packet delay and its jitter for Gigaset N870 IP PRO base stations.

### Cluster selective LAN synchronisation

LAN synchronisation consists of two layers:

- Standard PTP which is shared within a multicast IP domain between all DECT managers (cluster numbers 1-c to 7-c)
- Proprietary DLS (DECT over LAN Sync) which synchronises the clusters isolated within one DECT manager (cluster numbers 8-i to 15-i)

#### Cluster numbers from 1-c to 7-c

- Build up one common PTP sync domain
- DECT manager can be splitted in multiple DLS domains (clusters):
  - Maximum one LAN master per cluster
  - Intra-DECT manager split in clusters is possible for LAN sync,
  - Same way as for DECT sync
- DLS sync master and slave do care for matching DECT manager and cluster numbers
- Multiple DLS domains possible per DECT manager as DECT manager clusters
- Inter-DM-LAN sync is only possible with matching cluster number (independent from the PTP domain)

#### Clusters numbers 8-i to 15-i

- Build up an isolated PTP sync domain per each such cluster number
- DECT manager can be splitted in multiple DLS domains (clusters):
  - Maximum one LAN master per cluster
  - Intra-DECT manager split in clusters is possible for LAN sync
  - Same way as for DECT sync
- DLS sync master and slave do care for matching DECT manager and cluster numbers
- Multiple DLS domains possible per DECT manager as DECT manager clusters
- Inter-DM-LAN sync is only possible with matching cluster number (independent from PTP-domain)

A cluster forming an isolated PTP domain needs to have one LAN master of its own.

DECT managers forming one common LAN synchronisation domain need to use a cluster number from common domain (1..7) or an identical cluster number of isolated domain (8..15).

DECT managers using different PTP domains (cluster numbers 8..15) cannot be synchronised by inter-DECT manager LAN synchronisation rule (Reference=**LAN Master of DM x**), but only by inter-DM DECT synchronization rule.

The mentioned PTP domain in aspect of cluster numbers is only relevant for LAN master and LAN slave base stations. For DECT synchronisation, cluster numbers do not have any additional relevance beside just identifying different clusters.

### Acceptable Network Jitter for LAN-synchronisation

LAN synchronisation is based on a two layer design:

- Native PTPv2 is used to synchronise a common reference timer along all base stations involved.

Target quality benchmark to provide sufficient PTP synchronisation along the base stations, is to have a **PTP deviation lower than 500 ns** (rms). For this PTP synchronisation a few single deviations > 500 ns are accepted and might just generate first warnings. If the PTP sync packet deviation does continuously exceed this limit of 500 ns, the PTP synchronisation is considered broken and will lead to new start synchronisation procedure.

- Based on the PTP synchronisation LAN master and LAN slave adjust their DECT reference timer to one common offset to the common PTP reference timer. This common offset will be permanently monitored by a proprietary communication.

The target quality benchmark for this synchronisation level is to see reference timer deviation by this DECT reference timer sync packets: **DECT-LAN-Sync deviation lower than 1000 ns**. A good mean value would be 500 ns (rms).

To meet this criteria the switches themselves do not necessarily need to be PTP aware. But the network should consider the above mentioned guidelines to meet this criteria.



Further information on PTP is available from [wiki.gigasetpro.com](http://wiki.gigasetpro.com).

## Example scenarios for small/medium systems (single DECT manager clusters)

Synchronisation for handovers between base stations in clusters managed by one DECT manager are configured via the base station administration using the web configurator. Below are some example scenarios. Detailed information on configuration can be found in the N870 IP PRO Administration Guide.

### Scenario 1: Pure DECT

- Your environment ensures a stable DECT over the air synchronisation
- Cluster 1-c is created to insure handover, roaming and load balancing
- The base station in the centre is DECT level 1 to reduce the amount of sync levels
- Environment blocks DECT signal (e.g., a passage through a fire door)
- Second cluster 2-c is created to cover the area that can't be reached by cluster 1-c
- No handover (active calls are disconnected when switch over between clusters)
- Roaming between clusters is possible (handsets in idle mode can switch between clusters)

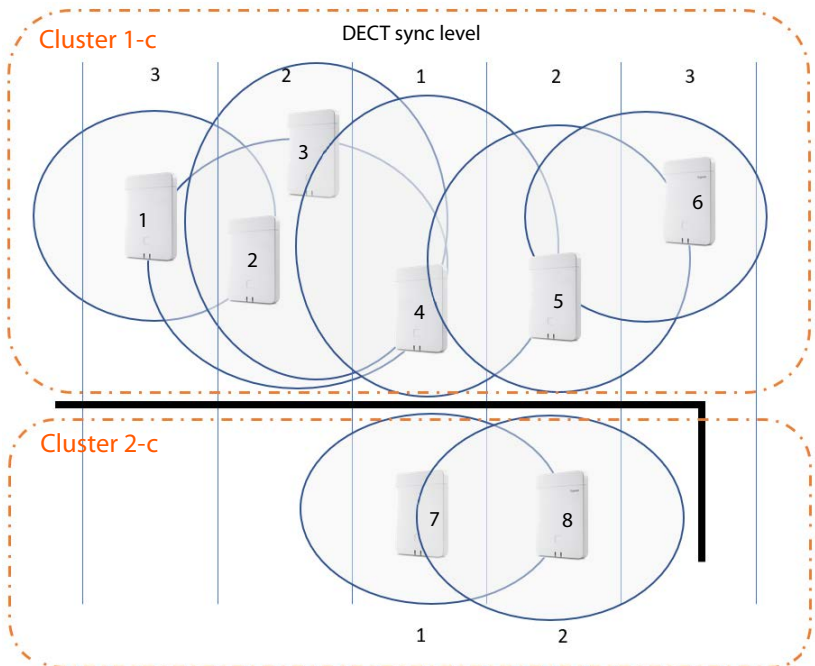

## Planning a DECT multicell network

### Scenario 2: Pure LAN

- Use such a configuration, if all requirements for LAN synchronisation are fulfilled
- Cluster 1-c is created to insure handover, roaming and load balancing
- Base 4 is configured as LAN master
- DECT level has no relevance for pure LAN synchronisation
- Handover and roaming is possible within the whole DECT environment
- That LAN sync is used, does not mean that DECT signal range is not important

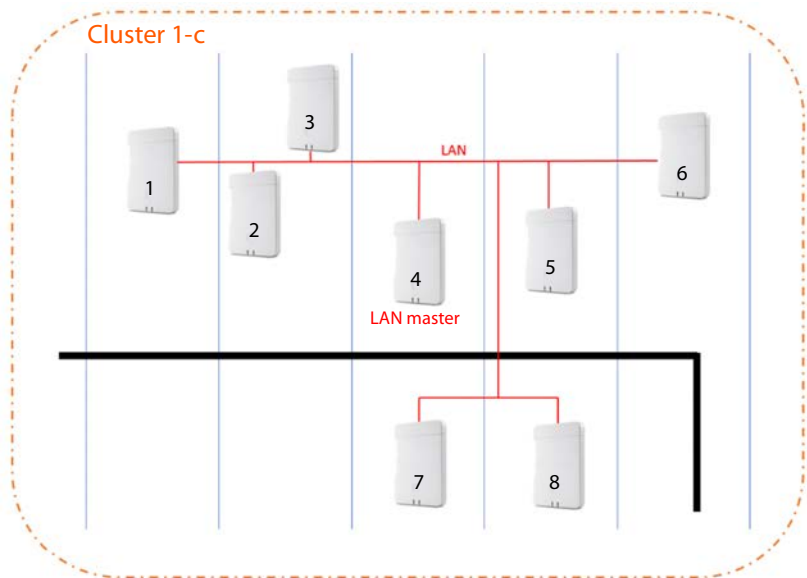

### Scenario 3: DECT-LAN mixed

- Use such a configuration, if your environment is mainly able to synchronise via DECT but there are particular circumstances which cannot always guarantee reliable DECT synchronisation, e.g., a passage through a fire door
- Cluster 1-c is created to insure handover, roaming and load balancing
- Base station 1 in the centre is DECT level 1 to reduce the amount of sync levels
- Base 1 with DECT level 1 is configured as LAN master
- For each base lower than the LAN master you can individually decide whether it should be synchronised via DECT or LAN
- Base 7 is synchronised via LAN and has DECT sync level 4
- Base 8 is synchronised via DECT and will synchronise with Base 7 via DECT, therefore the DECT sync level 5

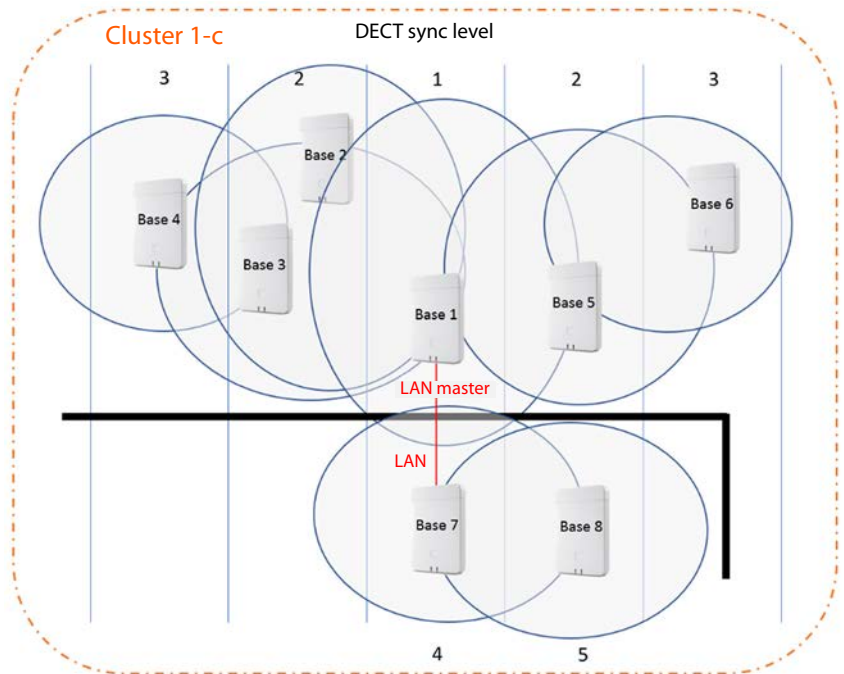

### Example scenarios for large systems (multiple DECT manager clusters)

Synchronisation for handovers between base stations in clusters managed by different DECT managers are configured via the DECT manager administration using the web configurator. Below are some examples based on two DECT managers. Detailed information on configuration can be found in the N870 IP PRO Administration Guide.

#### Scenario 1: DECT – DECT – DECT

- Integrator (virtual or embedded)
- Two devices with role of DECT manager only
- Every DECT manager has two DECT base stations
- Cluster 1-c on the left side uses DECT synchronisation
- Cluster 1-c on the right side uses DECT synchronisation too (even if the name is the same, it is a different cluster as it is part of another DECT manager)
- Between the clusters also DECT synchronisation is used

Advantage:

- Users can move within the system with handover and roaming.
- DECT synchronisation, no network requirements for LAN sync.

Attention:

- Enough DECT signal quality should be available within the complete system, also between the clusters.
- Every DECT manager must have a different RPN group.

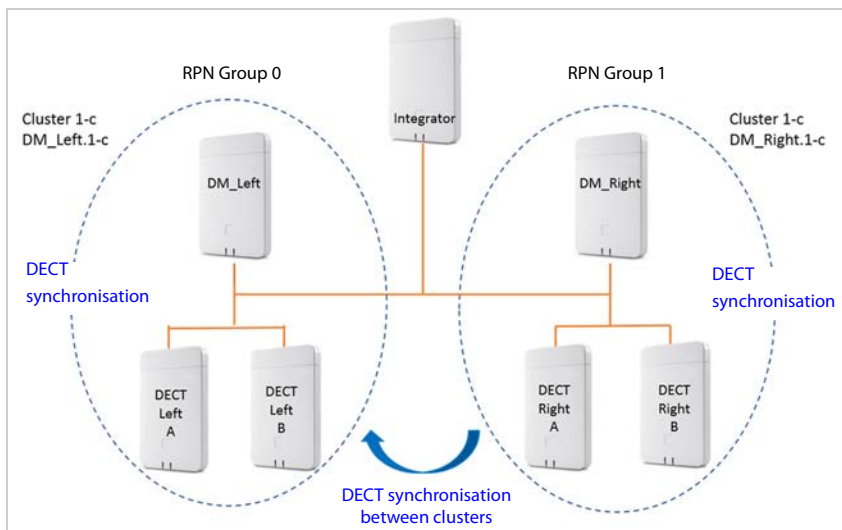

### Scenario 2: DECT – DECT – LAN

- Integrator (virtual or embedded)
- Two devices with role of DECT manager only
- Every DECT manager has two DECT base stations
- Cluster 1-c on the left side uses DECT synchronisation
- Cluster 1-c on the right side uses DECT synchronisation too (even if the name is the same, it is a different cluster as it is part of another DECT manager)
- Between the clusters LAN synchronisation is used
- Base station **DECT\_Left\_A** is the PTP source (LAN master)

#### Advantage:

- Users can move within the system with handover and roaming.
- Synchronisation between the two clusters was not possible due to DECT signal range was not enough. LAN sync is the solution.

#### Attention:

- The customer network between the clusters must be capable to be used for LAN synchronisation. This needs more configuration in the customer network than using DECT synchronisation.

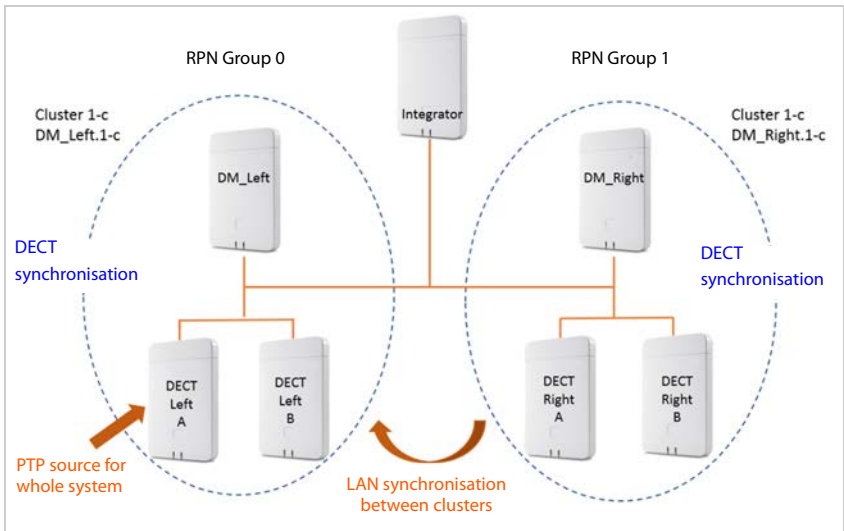





## Projecting the DECT network

There are a number of conditions to be considered when setting up a DECT network. They affect the subscribers' requirements for the telephone system as well as the technical requirements for the DECT wireless network. These conditions must therefore be recorded and evaluated in a projection phase.

To project your DECT network, proceed as follows:

- First determine the requirements for the telephone network and establish the environmental conditions for the DECT wireless network.
- Define how many base stations are required and their probable optimum positioning. Create an installation plan for the base stations.
- **Large installations:** Specify how many DECT managers are required. You need an additional DECT manager when the base stations are not in the same LAN subnet, and when you use more than 60 base stations and/or more than 250 handsets. You can deploy a maximum of 100 DECT managers. In a multi-DECT manager system, you require an integrator as a virtual machine (→ p. 6).
- Take measurements to check whether the positioning of the base stations at the assumed positions meets the requirements and whether the reception and sound quality is sufficient everywhere. If necessary, change the installation plan to optimise the DECT wireless network.

## Determining the requirements for the telephone network

Clarify the following to determine the requirements for the telephone network:

### Subscribers and subscriber behaviour

- How many employees should be able to make calls and how many subscribers should be able to make calls simultaneously?
  - How many handsets are required?
  - How many base stations are required?
- Where should telephone calls be possible?
  - In which buildings (floors, stairwell, basement, underground garage)?
  - Outdoors (on footpaths, on the car park)?  
For more information on this, refer to Section **Outside area** → p. 34.
  - How are the handsets distributed from a location perspective?
- How many calls will be made?
  - What is the telephony behaviour of the subscribers? How long is the average call?
  - Where are the hotspots, i.e., where do a lot of subscribers gather simultaneously (open-plan office, canteen, cafeteria, etc.)?
  - Where are telephone conferences held? How many telephone conferences are held and how long are these?

### Environmental conditions

- Where is the site that is to be covered by the DECT wireless network?
  - Total area of the required wireless coverage
  - Position and dimensions of the rooms, building plan
  - Number of floors, basements
    - ▶ Request a building plan that shows positions and dimensions and that can be used to document the subsequent installation planning.
- What is the basic structure of the building?
  - What materials and construction types have been used for the buildings?
  - What type of windows does the building have (e.g., tinted glass)?
  - What construction changes are expected in the near future?
- What interference influences can be identified?
  - What are the walls made of (concrete, brick, etc.)?
  - Where are the lifts, fire doors, etc. located?
  - What furniture and devices are present or planned?
  - Are there other wireless sources in the vicinity?

For detailed information on material characteristics and interference factors, → p. 31.

---

## Conditions for the positioning of the base stations

---

### Conditions of the N870 IP PRO Multicell System

In the planning stage, you must take into account which build level of the N870 IP PRO multi-cell system you install, which codecs you use and which role a device used has.

#### Installation

- **Small installation:** requires a N870 IP PRO device as integrator / DECT manager / base station and can manage up to 10 base stations and up to 50 handsets.
- **Medium-sized installation:** requires a N870 IP PRO device as integrator / DECT manager and can manage up to 60 base stations and up to 250 handsets.
- **Large installation:** permits the use of up to 100 DECT managers and can manage up to 6,000 base stations and up to 20,000 handsets.

For more information on the installations, refer to → p. 5

#### Codec and bandwidth

The number of parallel connections possible depends on the codecs permitted.

- If only codec G.711 is approved, a base station can realise up to 10 connections simultaneously.
- If codecs G.711 and G.729 are approved, a base station can realise up to 8 connections simultaneously.
- If broadband codec G.722 is approved (**HD voice**), a base station can realise up to 5 connections simultaneously.

#### Device role

The number of parallel calls possible reduces when a N870 IP PRO device houses a DECT manager, or integrator and DECT manager, at the same time as a base station (→ p. 10).

## Large installations: Using multiple DECT managers

The following must be considered when multiple DECT managers are used:

- For roaming and handover beyond DECT manager boundaries, neighbouring base stations must be synchronised. Synchronisation normally only takes place inside a cluster, i.e. roaming and handover beyond DECT manager boundaries are not possible. Synchronisation beyond DECT manager boundaries can be set up from the web user interface.
- The roaming process between two DECT managers is not entirely without transition (a handset switches from a wireless cell to a cell of a base station being managed by another DECT manager). Delays of several seconds can result. This is why DECT manager transitions should not be in areas of the DECT network with high levels of traffic.
- If the requirement is for roaming to be possible between base stations of different DECT managers, certain capacity for visitor handsets of other DECT managers must be planned in. The maximum number of handsets (250) that can register with a DECT manager reduces depending on the number of visitors expected. To make roaming possible at all times, a maximum of 80% of the maximum possible number should be registered, so about 200.
- Neighbouring DECT managers must belong to different RPN groups. This is also set from the integrator web interface.

---

## Technical conditions

The following values can be used as a guide for the planning. They are values that are influenced by environmental conditions and that should therefore be checked via measurements.

- The wireless range of a DECT base station for handsets is (guide values)
  - max. 50 m in buildings
  - Up to 300 m outdoors

These guideline values do not apply to the maximum possible distance between two base stations. To ensure the handover of a handset from the cell of one base station to the cell of another, this distance is derived from the necessary overlap zone.

- Ensure adequately sized overlap zones between neighbouring cells are taken into consideration. For an interference-free handover, a spatial overlap of 5 to 10 metres with satisfactory signal strength should be sufficient, even for fast walking. Neighbouring base stations must be able to receive one another with sufficient signal strength to guarantee the synchronisation and handover (→ p. 39).
- Maintain sufficient distance between the base stations as they can interfere with one another. The minimum distance depends on the circumstances. If no obstacles are present, the required distance can be 5 to 10 metres. If there is an absorbent wall or absorbent furniture between the base stations, 1 to 2 metres may be sufficient.

You will also find information about possible interference in Section **Material characteristics and interference factors**, → p. 31.

- In a horizontal direction, good connections can still be established behind 2–3 normal brick walls. In a vertical direction and on the ground floor or in basements, concrete ceilings are difficult to penetrate. This means that every floor may have to be supplied separately.
- Please note that in empty buildings, adding furniture and equipment (machines, movable walls, etc.) at a later stage will affect the wireless quality.
- Openings in obstacles improve the technical wireless conditions.
- Consider any possible interference factors (→ p. 31).

### Installation guidelines

The following points must be considered when installing DECT base stations:

- For wireless coverage within a building, always install the base stations on internal walls. Information on installation in an outside area, → p. 34.
- The optimal installation height for a base station is between 1.8 and 3 m depending on the room height. If you position the base stations any lower, furniture and moving objects can cause interference. There should be a minimum clearance of 0.5 m to the ceiling.
- We recommend installing all base stations at the same height.
- N870 IP PRO base stations require an Ethernet connection to the PABX, i.e. it must be possible to connect to the LAN.
- N870 IP PRO base stations are powered by PoE (Power over Ethernet, IEEE 802.3af). Therefore, you do not normally require a power connection. However, if you use an Ethernet switch that does not support PoE, you can use a PoE injector as an alternative. If there is an option of connecting to the mains power supply in the vicinity of the base station, you can also use the power adapter to provide a power supply (to be ordered separately).
- Do not install the base station in suspended ceilings, cupboards or other closed furnishings. The wireless coverage can be significantly reduced, depending on the materials used.
- The base station should be installed vertically.
- The location and alignment of the base station installed should be identical to the position deemed optimum during the measurement stage.
- Avoid installation in the direct vicinity of cable channels, metal cupboards or other larger metal parts. These can reduce the radiation and couple into interfering signals. There should be a minimum distance of 10 cm.
- To best exclude interference by transmitter or other indoor radio techniques, a distance of minimum 30 cm recommended.
- Observe the safety distances and safety regulations. Observe the regulations specified in rooms where there is a danger of explosions.

---

### Capacity measurement

The capacity of the DECT system must be high enough to guarantee that subscribers can be reached in high-density traffic. Both the capacity of the entire DECT system and the capacity of the individual cells must be taken into account.

The capacity of the DECT system is determined using the following criteria:

- Number of connection channels available

The number of connection channels available defines how many connections can be managed simultaneously.

**Note:** A connection channel is not only needed for phone calls. All actions for which a handset requires a connection to the phone system occupy a connection channel, such as accesses to the company phone book, querying the answering machine, group pickup, updating the time, . . .

The number of available connection channels on a N870 IP PRO depends on different factors  
→ p. 10.

- Grade of Service, GoS

The grade of service determines the number of connections that may not be achieved due to the system being at full capacity, i.e., the line is engaged. A grade of service of 1% means that out of 100 calls, one cannot be connected for capacity reasons.

The capacity required can be determined using these two factors and the traffic volume expected.

Please note that the volume of traffic can vary during the course of the day.

**The capacity must always be adjusted to the highest possible traffic volume if capacity bottlenecks are to be excluded.**

### Traffic volume



In order to calculate the traffic volume usually the Erlang B formula is used. This formula defines the probability of blocking, e.g., how many calls probably cannot be carried under given conditions. The Erlang B formula relates different values to each other:

- The load during the most active hour of the day (Busy Hour Traffic)  
This is given in Erlang (E). One Erlang corresponds to the continuous full capacity utilisation of one connection channel in a specific observation period, usually over an period of one hour. Accordingly, the occupation of a connection channel over one hour equals 1 E.
- Availability of channels  
Number of phone lines to be made available. The total bandwidth corresponds to the number of lines multiplied with the bandwidth of the used codec.
- Blocking rate (Quality of Service)  
Probability with which it will occur that a call cannot be accepted because all lines are busy.

Detailed information on the Erlang B formula can be found within technical literature for traffic theory. However, there are various Erlang B calculators provided in the Internet allowing you to calculate the necessary number of connection channels by giving the value of traffic load (E) and the desired blocking rate (QoS) without having further knowledge.

#### Example calculation:

Calculation details:

- It is a multi-cell system with only one DECT manager. The DECT manager system includes no base station, i.e. it is provided as a separate N870 IP PRO device. All other devices only include one base station.
- Narrowband connections with codec G.711 or G.729 are permitted, i.e. the base stations each have a maximum of 8 connection channels.

Traffic load (Erlang)	Quality of Service	Connection channels	Base stations
1000 calls (of 3 minutes each)/per 1 hour 1000 x 3 min./60 min. = 50 E	0.1 %	71	9
	0.5 %	66	8
	1 %	64	8
	2 %	60	8
	5 %	57	7

## Projecting the DECT network

Traffic load (Erlang)	Quality of Service	Connection channels	Base stations
2000 calls (of 5minutes each)/per 1 hour 2000 x 5 min./60 min. = <b>167 E</b>	0.1 %	202	26
	0.5 %	192	24
	1 %	187	24
	2 %	181	23
	5 %	170	22



Please consider that the effective availability of connection channels may be reduced by a lot of different influence factors. Therefore, to reach the required Quality of Service you should plan additional base stations as a buffer in any case.

### Alternative calculation for small systems

For smaller systems, an approximate evaluation of the traffic volume can be sufficient.

#### Example:

Calculation details:

- It is a small-scale system. One N870 IP PRO contains the integrator, DECT manager and a base station.
- Narrowband connections with codec G.711 or G.729 are approved.
- The base station that is on a system together with the DECT manager and integrator makes available 5 connection channels. The other base stations each have 8 connection channels.
- The traffic volume is evaluated for every area as "low", "medium" or "high". The evaluation specifies the number of handsets (as a %) that require a connection simultaneously.

Number of handsets, that can be served with GoS  $\leq 1\%$ :

Available codecs	Connection channels	Traffic load examples		
		Low (0.1 E/user)	Medium (0.15 E/user)	High (0.2 E/user)
Wideband DECT: supporting G722	5	14	9	7
Narrowband DECT: G711 or G729	8	31	21	16
Narrowband DECT: G711 only	10	45	30	22

### Hotspots

A hotspot is an area in which more calls than average are conducted simultaneously, e.g., open-plan offices or other areas where there are a lot of handsets in a small space.

You can cover such areas with several base stations since the DECT bandwidths in the coverage areas of neighbouring base stations add up. The DECT standard provides 120 radio channels that can be shared by several base stations. In practice, however, approximately only one quarter of these radio channels can be used without special measures, since the neighbouring channels interfere with one another. This results in a practical value of a maximum of 30 simultaneous connections. With a maximum of eight handsets per base station, this means that four N870 IP PRO base stations would be required.

If we assume that a maximum of 50% of the available handsets are making a call simultaneously in a hotspot, 60 handsets can be used with four base stations.

If interference frequently occurs at a hotspot or more than 30 connections are required simultaneously, the following measures are possible:

- Distribute the base stations that cover the hotspot as widely as possible at the boundaries of the hotspot so that they are as far away from each other as possible and mutual interference is minimised.
- If this measure is not sufficient, use walls or other suitable means to diminish the strong signals.
- It might also be helpful, if the circumstances at the location allow, to arrange the base stations in the shape of a ball, i.e., cover the hotspot through floors and ceilings.

When optimising the coverage of the hotspot areas, make sure that handsets do not suddenly occupy the call channels of the hotspot base stations that were previously supplied by other base stations. When establishing a connection, handsets always occupy channels of the base station that provides the strongest signal. Therefore, moving the hotspot base stations may affect other base stations and you may have to relocate the base stations of the entire network.

---

### Material characteristics and interference factors

There are a number of interference factors that influence the range and quality of the transmission in particular. The types of interference factors include:

- Interference as a result of obstacles that diminish the signal transmission, creating radio shadows
- Interference through reflection that restricts the call quality (e.g., crackling or background noise)
- Interference through other radio signals that can lead to errors in transmission

#### Interference due to obstacles

Possible obstacles are:

- Building constructions and installations such as reinforced concrete ceilings and walls, stairwells, long corridors with fire doors, uptakes and cable channels.
- Metal-clad rooms and objects such as cold stores, computer rooms, metallised glass areas (reflections), firewalls, tank systems, refrigerators, electrical boilers etc.
- Movable metal objects such as lifts, cranes, carts, escalators, shutters
- Room furnishings such as metal shelves, filing cabinets
- Electronic devices.

It is often difficult to locate the exact source of the interference; particularly if the received signal strength of the local DECT signals fluctuates strongly within a few centimetres. In these cases, the interference can be reduced or corrected by small changes to the position.



Wireless coverage in lifts is normally poor or not available at all (→ p. 33).

## Projecting the DECT network

### Loss of range through building materials in comparison to a free wireless field:

Glass, wood, untreated	<b>Approx. 10%</b>
Wood, treated	<b>Approx. 25%</b>
Plasterboard	<b>Approx. 27 – 41%</b>
Brick wall, 10 to 12 cm	<b>Approx. 44%</b>
Brick wall, 24 cm	<b>Approx. 60%</b>
Aerated concrete wall	<b>Approx. 78%</b>
Wired glass wall	<b>Approx. 84%</b>
Reinforced concrete ceiling	<b>Approx. 75 – 87%</b>
Metal-coated glass	<b>Approx. 100%</b>

### Interference from other wireless cells and networks

DECT is very robust against interference from other wireless networks. Co-existence with WLAN for example is not a problem. Most other asynchronous DECT single base stations do not present a problem either.

Problems may occur in special cases, such as an environment where there is a very high level of DECT usage. This applies when there are co-existing asynchronous DECT base stations but, even more so, when base stations have been installed too closely together to cover a hotspot, for example.

Despite sufficient signal strength, the following interference can occur:

- Unexpected termination of the connection
- Loss of synchronisation of handsets
- Poor voice quality
- ▶ When interference occurs because base stations are installed too closely together, try to resolve the problem with the measures described in Section **Hotspots** (increase the distances, use obstacles to absorb the interference, → p. 30)
- ▶ If you have found other DECT sources, check whether you can switch them off, relocate them or integrate them in your DECT network.

### Summary

Wireless traffic interference can have many causes that cannot all be determined in advance, that increase or decrease due to mutual influences and that can change during operation.

Therefore, the actual influence of interference factors on reception and voice quality can only be determined by taking measurements. However, the measurements also only provide an image of the wireless network at the time of measurement. We therefore recommend that when you plan the DECT network areas where interference can be expected, you err on the side of caution when you interpret the thresholds.



## DECT installations in special environments

The **Projecting the DECT network** and **Taking measurements** sections describe all prerequisites and steps for planning a DECT network. In addition to the examples and applications described there, this section contains notes for special construction or topographical requirements.

### DECT networks over several floors

If the DECT network is to cover several floors of a building, you must consider the following when planning the number and location of base stations:

- What material are the suspended ceilings made from?  
If they are reinforced concrete, only one ceiling can be positioned between the base station and telephone for a direct wireless path. Furnishings and partitions in rooms etc. can restrict the wireless transmission even further.  
Use measurements to check where further base stations are required.
- To what extent must a handover between the floors be guaranteed?  
In this case, the base stations must be positioned such that stairwells are also completely covered. Note also that any fire doors or walls can reduce the wireless transmission severely. Add the vertical levels of your planned coverage areas to your measurement plan and record the vertical transmission of the DECT network.
- No handover between floors required  
In this case you can work with clusters (more cost-effective). If you set up one cluster for each floor, the base stations of the cluster are synchronised with one another and a handover is possible. Handover is not possible between floors, but the IP PABX functions (VoIP configuration, directories, etc.) are available in all clusters.

### Stairwells and lifts

Stairwells often have particularly absorbent walls (e.g., reinforced concrete); access to the stairwell may be restricted by fire doors. Planning of the DECT network is therefore subject to special requirements here.

If you want calls via the DECT network to be possible in the stairwell, the most cost-effective variant is to install one (or even several) base station(s) as a separate cluster.

If a handover is required in the stairwell, you should check the position of the stairwell to the corridors (transitions, doors, fire doors), measure the wireless coverage and, if necessary, provide one or more base stations for wireless coverage of the stairwell.

Making calls in lifts is usually not possible due to the highly absorbent and/or reflective materials. However, if this is a requirement, you can check whether you can achieve sufficient signal strength and quality for making calls in a lift by installing a separate base station in the lift shaft.

### Several buildings

Planning a DECT installation for several buildings or for separate parts of buildings requires clarification of the following:

- Should calls only be possible within the internal rooms or across the whole site, even in the outside area?
- In which area should handover be guaranteed?

The cheapest way to connect separate parts of buildings with the DECT system is to use separate clusters (subnet). In this case, only the wiring of the different buildings or building parts via the

## Projecting the DECT network

LAN must be ensured. All phones registered with the DECT system can be used everywhere; handover is not always possible however.

### Outside area

The outside area of a building can often be included in the DECT network through a base station close to a window. The prerequisite for this is that the glass in the window must not contain any metal (metal film, wire mesh).

If the outside area cannot be covered by base stations within the building, a base station can also be installed in the outside area. The base station should then be mounted in a suitable external housing to protect it against weather conditions (available from third-party manufacturers). The thresholds for the operating temperature of the base stations (+5° to +40°) must be taken into consideration.

The installation can be on a mast (not metal), on the roof or on a wall of the building. Please note that the LAN connection must be guaranteed, as this supplies the device with power and is also required for the connection to the DECT Manager.

The range on the site is up to 300 m, but might be restricted by other buildings, walls or trees. A base station mounted in the outside area can also cover further indoor parts of buildings if the walls of these areas do not reduce the radio signal too strongly.

For measurements outside, please note that weather conditions, e.g., rain or snow, can significantly influence the send and receive properties. If necessary, perform further measurements in different weather conditions; plan the radio coverage generously if you want to guarantee secured reception. Changes in the vegetation (leaves on the trees, growth of bushes) can also affect the radio conditions.

### Handover over the whole site

If handover is to be achieved over the whole site, including all buildings, the transition areas between internal rooms and the outside area must be planned and measured carefully.

Example: The building can only be accessed through a metal door with 100% absorption. In this case, when the door is open the handover between the nearest base station indoors and the base station for the outside area must be guaranteed. Both base stations must be synchronised and (with the door open) have the required overlap area.

## Preliminary identification of the positions of the base stations

Now plan the positions of the base stations. Take the following into consideration:

- The information you have collected regarding the requirements for the telephone network
- Your synchronisation planning
- The technical conditions for the wireless DECT.

First create a plan in which you then enter the locations of the base stations. You can use existing building and supply plans, if applicable. For very large buildings, you may be able to work with partial floor plans and then merge the results of the measurements into the evaluation.

## Creating a planning drawing

Create a planning drawing from the information you have collected in the preliminary examination of the location. Enter building dimensions, hotspot areas and any sources of interference already identified.

**Example:**

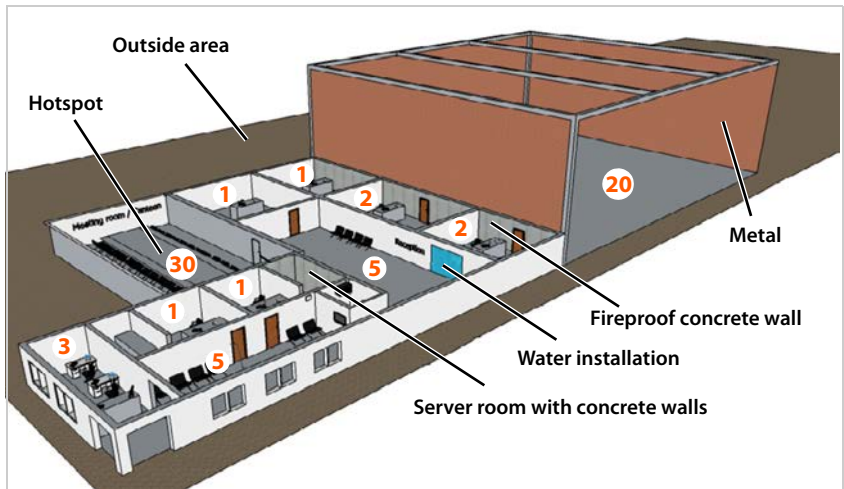

- The orange numbers in the rooms reflect the required number of DECT handsets (71 in total).
- Canteen is defined as a hotspot, where 30 calls should be possible simultaneously.
- Calls should be possible in the building and outside the building.
- Walls that are deemed to have a high absorption effect, or reflections, are indicated.

### Positioning the base stations in the plan

Now define the positions of the base stations in the building plan taking into account the required capacity and the determined influences. As far as possible, you can take note of visual concerns as well as possibilities of technical connectivity.

Give the locations for the DECT bases unique labels.

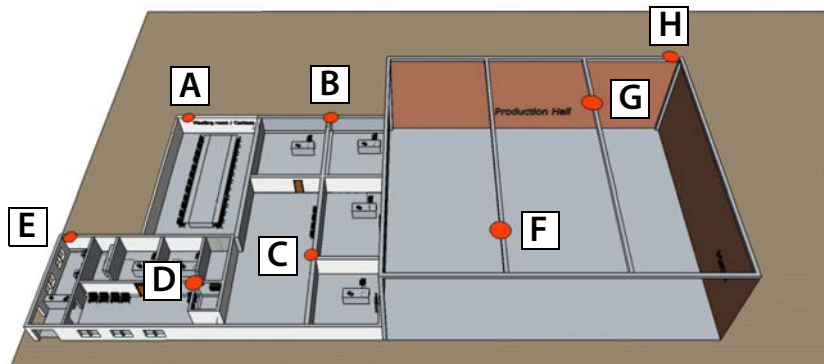

Initially, the assumption is that eight base station (shown as red circles) should be adequate as measurement is not done at this point.

- Base A, B, C, D and E cover the office area and can handle up to 50 parallel calls.
- The hotspot meeting room / canteen is covered with multiple bases to assure 30 simultaneous calls.
- The production hall is covered with two base stations (F and G).
- The outside area is covered with base A, B, E and H.

You then check these initial assumptions later using the measurements ( → p. 38).

## Hints for mounting base stations

Observe the following notes when mounting base stations:

- Min. 1.8 m distance from the ground.
- Min. 0.5 m distance from the ceiling.
- Optimal height between 1.8 and 3 m.
- Min. 0.3 m distance between two base stations.
- Min. 5 - 10 m distance to not synchronised base stations.
- Install all base stations at the same height.
- Operating temperature between +5 ° and +45 °.
- Minimum 10 centimetres recommended distance from metal, supply lines and cable ducts.

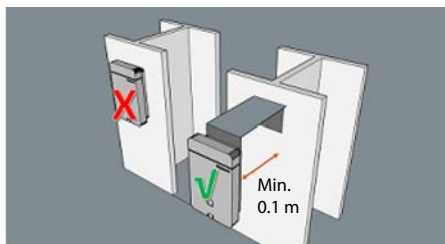
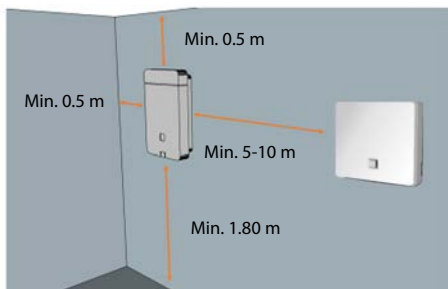

- The base stations should be installed vertically.

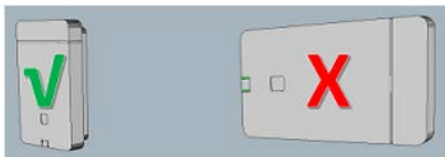

- Do not install the base stations on ceilings, or suspended cup boards or other closed furnishings.

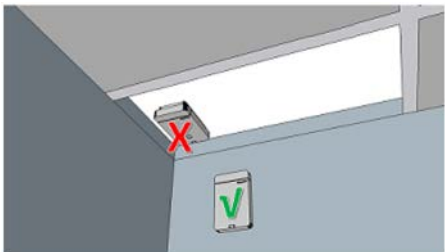

Important is that the location and alignment of the base stations installed should be identical to the position deemed optimum during the measurement stage.

# Taking measurements

You have:

- Determined the requirements for the telephone network ( → p. 25)
- Planned the number of base stations and their positions ( → p. 35)
- Set up and operated the measurement equipment.

You can now start the measurements for your planned DECT network. The aim of the measurements is to determine the following:

- Is sufficient wireless coverage and a good voice quality guaranteed everywhere in the desired area?
- Is synchronisation of the base stations ensured in their planned positions?
- Is a handover between the base stations possible where it is required?

The requirements from these three aspects must be taken into account in the measurements. For information on this, please also refer to Section **Conditions for the positioning of the base stations** → p. 26.



Gigaset provides the DECT Site Planning Kit (SPK) PRO as tool for radio coverage and quality measuring of your DECT network. For information on installing and operating the measure equipment refer to the "DECT Site Planning Kit (SPK) PRO" user guide.

For measurement you can also use any other measuring equipment for DECT radio networks.

## Notes for taking the measurements

- Take two different measurements:
  - Measure the connection quality in the wireless coverage area for the planned base stations.
  - Measure the signal quality between the base stations (synchronisation measurement).
- To measure the connection quality, establish a telephone connection. It is helpful if the measurements are performed by two people, since they can check the voice quality and interference on two measuring handsets directly in a call. If only one person performs the measurements, the connection quality can possibly be checked via a test tone.
- You can also test the connection quality by holding the handset to your ear as you measure, in the same way as you would in a real telephony situation. Turn around as you do so. Note how the acoustics quality of the test tone changes. If interference occurs at the limit of the range (e.g., crackling), power at the measuring site is critical. Your head can impair reception. For this reason, the test against your ear is an additional check for verifying the reception quality in limit areas.
- Use the measuring handset in idle status to measure the signal quality between the base stations. The main criteria for signal quality between base stations is the signal strength. Of course, if the frame quality is already showing lowered quality, this indicates that the quality is not good enough for over the air synchronisation along that path.
- Using the stand, position the measuring base station as precisely as possible in relation to the intended position for the base station.
- To measure the signal strength between base stations, position the measuring handset in the exact planned position of the base station. For example, if you want to position the base stations at a height of 3 m, make sure the measuring handset is at this height.

- Installation closed to metal surface should be prevented best as possible. But if metal surface has to be accepted for the operation, it should **not** be removed for the measuring.
- Document the progress of the measurement by entering it in the layout plan (horizontally and, where applicable, vertically) and in a measurement log.
- In order to be able to recognise subsequent changes, it is helpful to document the planned assembly positions of the individual measurement series and their environment with photographs.
- If the DECT system is to be used for several floors or very high rooms (e.g., with a gallery), you must also measure the vertical range and enter it in a plan of the building. For further information on this, please also refer to the DECT installations in special environments chapter → p. 33.

### Fluctuations in the measurement result

When you are performing the measurements, the signal strength displayed on the handset can fluctuate strongly, particularly if you are moving around with the handset. The base stations have two aerials, so the handset displays the values for the aerial for which it receives the best signal. Since the measuring handset takes measurements at defined time intervals (2.5 seconds as standard), the values can change quickly.

For example, if you block the signal for the aerial that is in a better position for the handset with part of your body, the handset receives the signal from the weaker aerial. Turning your body slightly can significantly alter the measurement value, since the handset is suddenly able to receive the signal from the "better" aerial. By moving around, you determine an average value that you can use as the measurement value.

In case of marked fluctuations it makes sense to perform the measurement while a connection is established as you then have an additional check based on voice quality.

When the DECT system is being operated in real-life situations, these fluctuations are barely noticeable as the base stations automatically establish the connection with the best positioned aerial.

---

## Defining thresholds

During the measurement process, the measuring handsets receive wireless signals from the measuring base station and display various characteristics for the reception quality. The following are relevant for the reception quality:

- Received signal strength
- Connection quality

The values specified below are guidelines for determining thresholds for operating the DECT telephone system under optimum conditions. Since the DECT network can be restricted by many factors that can also occur temporarily, we do not recommend positioning the base stations at the thresholds. Instead, you should include a buffer according to the requirements for grade of service and voice quality. It may be acceptable for example, that voice quality is restricted at times in the basement, and that calls cannot always be made there. In contrast, restrictions are unacceptable for meeting rooms where telephone conferences are held.

### Received signal strength

The reception field strength is measured to assess the quality of transmission. The received signal strength (proportional to the field strength) is displayed on the measuring handset in dBm. A very good received signal strength is approximately -50 dBm. Systems that are measured at up to -60 dBm generally offer a good quality. For measurements up to -70 dBm, the measurement must be checked and evaluated with an audio connection to ensure sufficient quality. A handover is no longer possible in this area.

Different thresholds can be used for the measurement, based on the quality or use of specific areas (e.g., office, corridor, basement). Different quality requirements can also be defined at the various base stations within a partial system.

Typical thresholds for normal, low-interference environments are:

- 1 Limit value for guaranteed call quality: -65 dBm

This is the value at which a handset must receive the signal of a base station for a subscriber to be able to benefit from good quality telephony. For an interference-free handover, the handset must receive both base stations at this level of quality.

- 2 Limit value for synchronisation -70 dBm

This is the value at which a base station must receive the signal of another base station to be able to synchronise.



When the received signal strength is not high enough in certain areas for synchronisation using DECT, base stations can also be synchronised over LAN. A minimum received signal strength must also be available here however (→ p. 13).

The following table gives an initial guideline for the quality of the wireless connection.

Received signal strength	Quality evaluation
-50 dBm	Very good
-60 dBm	Good
-65 dBm	Satisfactory
-70 dBm	Adequate
-73 dBm	Weak, not suitable
-76 dBm	Poor, not suitable



## Connection quality

In principle, the measurement of the field strength should always be supplemented by a check of the connection quality. Interference, e.g., through reflection or external systems that influence the voice quality, can also occur with good received signal strength.

The **Frame quality** is therefore also displayed on the measuring handset in addition to the received signal strength. This indicates the percentage rate of the packages received without errors in a measurement interval. The optimum value is 100%.

Frame quality	Quality evaluation
100%	Good
99%	Satisfactory
98%	Adequate
97%	Weak, not suitable
96%	Poor, not suitable

## Measuring the wireless range of the planned base stations

Take two different measurements.

- 1 Measure the connection quality between the measuring handset and measuring base station in their wireless cells to ensure that sufficient voice quality is guaranteed at every position in the required coverage area. Taking the same measurement for the neighbouring station produces the overlap zone required for a handover.
- 2 Measure the strength of the signal from the measuring base station that you receive at the planned position of the neighbouring base station to ensure sufficient synchronisation overlap.

### Measurement sequence

The sequence in which you measure the wireless range of the planned base stations depends on the size of your DECT network and your assumptions with regard to the existing "problem areas". As a rule of thumb, first measure the base stations whose positions have the least leeway.

Take the following aspects into consideration:

- Assumed problem areas

For base stations that are to cover specific problem areas, e.g., a stairwell or entrance area, there are often few alternative positioning options. In this case, measure these base stations first because the positioning of all other base stations depends on these initial positions.

- For large installations

The more base stations you use, the higher the requirements of the synchronisation hierarchy (→ p. 14). In this case, we recommend starting with the base station for which a subsequent change would mean the greatest effort. This is usually the base station with sync level 1. Start here and move outwards from sync level to sync level.

- For small installations

Here it makes sense to start with the base station where the highest call traffic is to be expected, e.g., base stations in hotspots or other high-traffic areas. Once the coverage of these areas is ensured by measurement, check the positioning of the other base stations.

### Measuring the cell of a base station

- ▶ Temporarily secure the measuring base station in the position in which the base station is to be installed.
- ▶ Establish a telephone connection between the two measuring handsets or activate the continuous test tone of the measuring base station, if available.
- ▶ Move away from the base station with the handset, observing the display and the signal in the earpiece, until the limit value of  $-65$  dBm is displayed or a wireless transmission boundary is reached (e.g., lift, exterior wall). Transfer this point to your plan and enter the value in the measurement log.
- ▶ Use this method to determine the border line around the base station. The theoretical ideal case of a ring-shaped transmission is considerably altered in reality by walls (depending on the construction material) and metal furnishings.
- ▶ Check the voice quality in the limit areas using the connection to the second measuring handset or the measuring tone of the base station.
- ▶ Enter deviations in the reception signal measurement of the voice quality in the layout plan or the measurement log.

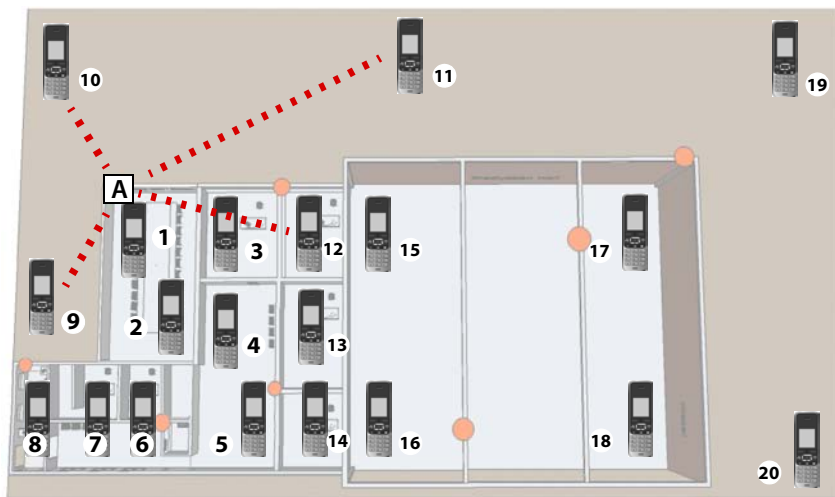

### Example of a measurement log for the cell of a base station

Measuring point	Base station A
1	-60 dBm/100%
2	-65 dBm/98%
...	...
14	-73 dBm/70%
...	...
20	---

If you have measured the cells of multiple base stations, the results may look like this, for example:

Measuring point	Base station A	Base station B	Base station C	Base station D	...
1	-60 dBm/100%				
2	-50 dBm/98%				
3	-65 dBm/100%				
4	-48 dBm/100%				
5	-55 dBm/98%				
6	-65 dBm/100%	-50 dBm/100%			
7	-68 dBm/96%	-59 dBm/100%			
8	-55 dBm/98%	-46 dBm/98%			
9		-60 dBm/96 %			
10		-52 dBm/98%	-65 dBm/100%		
11		-63 dBm/100%	-57 dBm/100%		
12		-48 dBm/98%	-42 dBm/100%		
13			-46 dBm/98%		
14			-40 dBm/100%		
15			-60 dBm/98%	-52 dBm/100%	
16			-43 dBm/100%	-42 dBm/100%	
17				-56 dBm/100%	
18				-50 dBm/98%	
19				-53 dBm/100%	
20				-60 dBm/98%	

Measuring points where two base stations are received with at least -65 dBm are located in an overlap zone of the two base stations in which a handover is possible (highlighted grey in the table).

### Measuring the synchronisation overlap of neighbouring base stations

For the base stations to be able to synchronise via DECT, the signal strength between two neighbouring base stations must not be less than  $-70$  dBm. This value applies in good environmental conditions, → p. 39.

Proceed as follows for the measurements:

- ▶ Leave the measuring base station at the last measuring site and proceed with the handset to the planned position of a base station that is to synchronise with the first base station.  
In order to reliably assess the synchronisation, you must be located, with the handset, at the exact position of the planned base station (use a ladder to measure at the correct height, if necessary).
- ▶ Check whether the signal is within the limit of  $-70$  dBm at 100% frame quality. If this is not the case, you should change the location of the base station until this minimum requirement is met. Alternatively, you can think about LAN synchronisation between
- ▶ Install the measuring base station at this location and take the measurements as for the first position.
- ▶ Enter the results in the plan and the measurement log.
- ▶ Now take this measurement for all planned assembly locations.

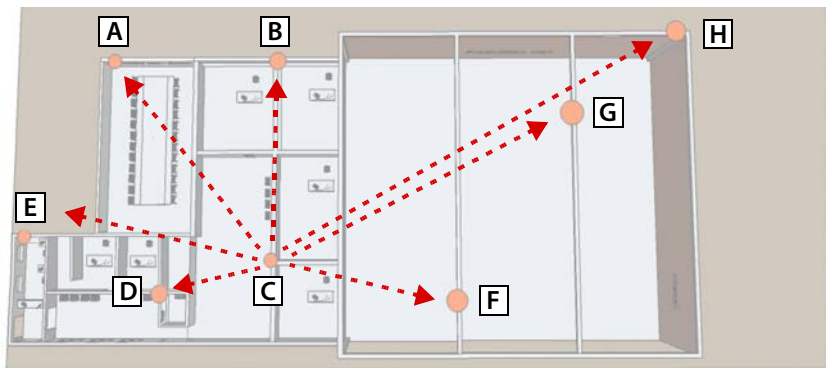

### Example of a measurement log for measuring the synchronisation overlap

M.point	BS A	BS B	BS C	BS D	BS E	BS F	BS G	BS H
A		-52 dBm/ 100%	-40 dBm/ 100%	-58 dBm/ 100%	----	----	----	----
B	-50 dBm/ 100%		-48 dBm/ 100%	----	-70 dBm/ 92%	----	----	-60 dBm/ 93%
C	-42 dBm/ 100%	-46 dBm/ 100%		-50 dBm/ 100%	----	----	----	----
D	-60 dBm/ 100%	----	-48 dBm/ 100%		-64 dBm/ 100%	----	----	----
E	----	-68 dBm/ 94%	----	-62 dBm/ 100%		----	----	----
F	----	----	----	----	----		-52 dBm/ 100%	-56 dBm/ 100%
G	----	----	----	----	----	-50 dBm/ 100%		-54 dBm/ 100%
H	----	-62 dBm/ 100%	----	----	----	-56 dBm/ 100%	-53 dBm/ 100%	

The result of the measurement is that the signal strength is sufficient for synchronisation of base station A - E and H. Base station E only receives base station D with sufficient quality. Base station H only receives base station B, G and H with sufficient quality.

Here, a sensible synchronisation hierarchy would be:

- Sync level 1      Base station C
- Sync level 2      Base stations A, B and D
- Sync level 3      Base station E and H
- Sync level 4      Base station G and F

## Evaluating measurements

A graphical display of your measurement results in the layout plan may show the overlap areas of the individually planned base stations. However, the measurement results of all stations must be used to check whether a further base station is required in the areas.

- ▶ Using the measurement results (where necessary), define new positions for the base stations and check them with further measurements.  
Note that moving one installation location also influences the other measurement results. Always consider how this affects the synchronisation of the base stations.
- ▶ Enter the determined optimum installation locations for the base stations in the plan (including the height and special construction circumstances, if necessary). We recommend you also document the assembly positions with photographs.
- ▶ In particular, check rooms or areas with very high wireless signal shielding (e.g., lifts, reinforced concrete ceilings, etc.) and add further base stations to your plan where necessary.

Once the measurements are complete and the positions of the base stations have been defined, the telephone system can be installed. This is described in the user guide for the N870 IP PRO Multicell System.



### Recommendation

After installation and commissioning of the DECT network, the voice quality, roaming and handover should be checked again with the system telephones.

The web user interface for the N870 IP PRO offers different tools for monitoring the operation and diagnosis in the event of problems occurring.

The page **Status** → **Statistics** → **Base stations**

shows counters for various events occurring on base stations, such as active radio connections, incoming handover, outgoing handover and connections terminated unexpectedly.

On the page, you can also display graphics of the relationships between the base stations, the synchronisation level and information on the quality of the connections here.

### Example:

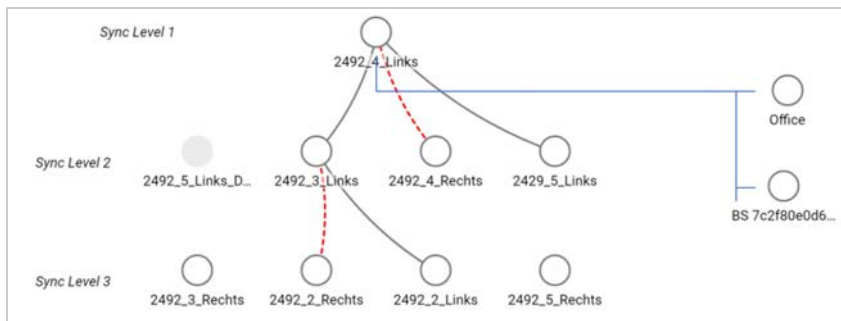

### Presentation:

Connections		
		RSSI range 43 - 100, good - excellent
		RSSI range 0 - 42, poor
		No data available

Base Status		
		Active and synchronised
		Other status (click on the symbol for more information)
		Deactivated

Synchronisation Mode		
		DECT, internal synchronisation
		DECT, external synchronisation
		LAN, internal synchronisation
		LAN, external synchronisation
		RFPI, external synchronisation

---

## DECT installations in special environments

The **Projecting the DECT network** and **Taking measurements** sections describe all prerequisites and steps for planning a DECT network. In addition to the examples and applications described there, this section contains notes for special construction or topographical requirements.

---

### DECT networks over several floors

If the DECT network is to cover several floors of a building, you must consider the following when planning the number and location of base stations:

- What material are the suspended ceilings made from?  
If they are reinforced concrete, only one ceiling can be positioned between the base station and telephone for a direct wireless path. Furnishings and partitions in rooms etc. can restrict the wireless transmission even further.  
Use measurements to check where further base stations are required.
- To what extent must a handover between the floors be guaranteed?  
In this case, the base stations must be positioned such that stairwells are also completely covered. Note also that any fire doors or walls can reduce the wireless transmission severely.  
Add the vertical levels of your planned coverage areas to your measurement plan and record the vertical transmission of the DECT network.
- No handover between floors required  
In this case you can work with clusters (more cost-effective). If you set up one cluster for each floor, the base stations of the cluster are synchronised with one another and a handover is possible. Handover is not possible between floors, but the IP PABX functions (VoIP configuration, directories, etc.) are available in all clusters.

---

### Stairwells and lifts

Stairwells often have particularly absorbent walls (e.g., reinforced concrete); access to the stairwell may be restricted by fire doors. Planning of the DECT network is therefore subject to special requirements here.

If you want calls via the DECT network to be possible in the stairwell, the most cost-effective variant is to install one (or even several) base station(s) as a separate cluster.

If a handover is required in the stairwell, you should check the position of the stairwell to the corridors (transitions, doors, fire doors), measure the wireless coverage and, if necessary, provide one or more base stations for wireless coverage of the stairwell.

Making calls in lifts is usually not possible due to the highly absorbent and/or reflective materials. However, if this is a requirement, you can check whether you can achieve sufficient signal strength and quality for making calls in a lift by installing a separate base station in the lift shaft.

### Several buildings

Planning a DECT installation for several buildings or for separate parts of buildings requires clarification of the following:

- Should calls only be possible within the internal rooms or across the whole site, even in the outside area?
- In which area should handover be guaranteed?

The cheapest way to connect separate parts of buildings with the DECT system is to use separate clusters (subnet). In this case, only the wiring of the different buildings or building parts via the LAN must be ensured. All phones registered with the DECT system can be used everywhere; handover is not always possible however.

### Outside area

The outside area of a building can often be included in the DECT network through a base station close to a window. The prerequisite for this is that the glass in the window must not contain any metal (metal film, wire mesh).

If the outside area cannot be covered by base stations within the building, a base station can also be installed in the outside area. The base station should then be mounted in a suitable external housing to protect it against weather conditions (available from third-party manufacturers). The thresholds for the operating temperature of the base stations (+5° to + 40°) must be taken into consideration.

The installation can be on a mast (not metal), on the roof or on a wall of the building. Please note that the LAN connection must be guaranteed, as this supplies the device with power and is also required for the connection to the DECT Manager.

The range on the site is up to 300 m, but might be restricted by other buildings, walls or trees. A base station mounted in the outside area can also cover further indoor parts of buildings if the walls of these areas do not reduce the radio signal too strongly.

For measurements outside, please note that weather conditions, e.g., rain or snow, can significantly influence the send and receive properties. If necessary, perform further measurements in different weather conditions; plan the radio coverage generously if you want to guarantee secured reception. Changes in the vegetation (leaves on the trees, growth of bushes) can also affect the radio conditions.

### Handover over the whole site

If handover is to be achieved over the whole site, including all buildings, the transition areas between internal rooms and the outside area must be planned and measured carefully.

Example: The building can only be accessed through a metal door with 100% absorption. In this case, when the door is open the handover between the nearest base station indoors and the base station for the outside area must be guaranteed. Both base stations must be synchronised and (with the door open) have the required overlap area.



# Index

- 
- B**
- Base station ..... 3, 7
    - events ..... 46
    - mounting hints ..... 37
    - positioning ..... 36
  - Base stations
    - minimum distance ..... 27
    - planning locations ..... 35
  - Broadband ..... 26
  - Building materials
    - loss of range ..... 32
  - Building property ..... 27
- 
- C**
- Capacity ..... 10
    - measuring ..... 28
  - Connection quality ..... 41
- 
- D**
- DECT base station ..... 3, 7
  - DECT integrator ..... 3, 5
  - DECT manager ..... 3
  - DECT managers
    - using multiple ..... 27
  - DECT network
    - planning ..... 25
  - DECT wireless network ..... 9
    - technical conditions ..... 27
  - Deployments ..... 5
  - Diagnostics ..... 46
  - Diagnostics, base stations ..... 46
  - DLS (DECT over LAN Sync) ..... 17
  - DSCP (Differentiated Services Codepoint) ..... 16
- 
- E**
- Embedded integrator ..... 7
  - Erlang ..... 29
- 
- G**
- Gigaset N870 IP Multicell System
    - capacity ..... 26
  - Gigaset N870 IP PRO
    - power supply ..... 28
  - Grade of service ..... 29
  - Grade of Service (GoS) ..... 29
- 
- H**
- Handover ..... 7
  - Handset ..... 4, 7
  - Hotspot ..... 30
    - interference ..... 31
- 
- I**
- Installation
    - large ..... 6
    - medium ..... 5
    - small ..... 5
  - Installation guidelines ..... 28
  - Installation height, optimum ..... 28
  - Integrator ..... 3, 5
    - embedded ..... 7
    - virtual ..... 6
  - Interference factors ..... 31
    - material characteristics ..... 32
    - obstacles ..... 31
    - other wireless networks ..... 32
- 
- J**
- Jitter ..... 18
- 
- L**
- LAN master/slave ..... 15
  - LAN synchronisation ..... 13, 15
    - advantages ..... 15
    - cluster selective ..... 17
  - Large installation ..... 6
  - Limit values ..... 39
  - Load balancing ..... 7
  - Loss of range ..... 32
- 
- M**
- Material characteristics ..... 31
  - Measurement
    - preparing ..... 25
  - Measurement log ..... 43, 45
  - Measurement process ..... 42
  - Measurement result ..... 45
  - Medium installation ..... 5
  - Minimum distance ..... 27
  - Multi-cell system ..... 3
- 
- N**
- Narrowband ..... 26
  - Network jitter ..... 18
- 
- O**
- Overlap ..... 12
- 
- P**
- Packet delay jitter ..... 16
  - Phone system ..... 4
  - Planning drawing ..... 35
  - PoE (Power over Ethernet) ..... 28
  - PTP (Precise Time Protocol) ..... 17
  - PTP deviation ..... 18

## Index

---

### R

Received signal strength .....	40
Limit values .....	40
Roaming .....	7

---

### S

Signal strength, received .....	40
Signal transmission .....	10
Small installation .....	5
Sync level .....	14
Sync master/slave .....	13
Synchronisation	
DECT .....	14
over LAN .....	13, 15
over the air .....	13, 14
requirements .....	16
Synchronisation example	
large, DECT-DECT-DECT .....	22
large, DECT-DECT-LAN .....	23
large, LAN-PTP domain-LAN .....	24
small/medium, DECT-LAN mixed .....	21
small/medium, pure DECT .....	19
small/medium, pure LAN .....	20
Synchronisation hierarchy .....	13
Synchronisation planning .....	13

---

### T

Taking measurements .....	38
Telephone network requirements .....	25
Traffic volume	
evaluating approximately .....	30
evaluating in erlangs .....	29

---

### V

Virtual integrator .....	6
VoIP PABX .....	3

---

### W

Wireless coverage .....	9
optimum .....	9
Wireless range .....	27

Issued by

Gigaset Technologies GmbH  
Frankenstr. 2, 46395 Bocholt, Germany

© Gigaset Technologies GmbH 2024

Subject to availability.  
All rights reserved. Rights of modification reserved.

[www.gigaset.com](http://www.gigaset.com)