

Gigasetpro

N720 SPK PRO

Multicell System

Site Planning Kit

BECAUSE IT'S YOUR BUSINESS.

Table of Contents

Safety precautions	3
Working with the Gigaset N720 SPK PRO	4
Checking the package contents	4
Further recommended accessories	5
Before you begin	5
Setting up the measuring base station	6
Starting up the measuring handset	10
Operating the measuring handset	12
Customer service and help	16
Questions and answers	16
Environment	16
Appendix	17
Approval	17
Care	17
Contact with liquid	17
Technical details	18
Index	20

Safety precautions



Read the safety precautions and the user guide before use.

Comprehensive user guides for all telephones and telephone systems as well as for accessories can be found online at gigasetpro.com in the Support category. We thereby help to save paper while providing fast access to the complete up-to-date documentation at any time.



The device cannot be used in the event of a power failure. In case of a power failure it is also **not** possible to make **emergency calls**.

Emergency numbers **cannot** be dialled if the **keypad/display lock** is activated!



Use only **rechargeable batteries** that correspond to the **specification** (see list of permitted batteries → www.gigaset.com/service). Never use a conventional (non-rechargeable) battery or other battery types as this could result in significant health risks and personal injury. Rechargeable batteries, which are noticeably damaged, must be replaced.



The handset must not be operated if the battery cover is open.



Do not use the devices in environments with a potential explosion hazard (e.g. paint shops).



The devices are not splashproof. For this reason do not install them in a damp environment such as bathrooms or shower rooms.



Use only the power adapter indicated on the device.

Whilst charging, the power socket must be easily accessible.



Remove faulty devices from use or have them repaired by our Service team, as these could interfere with other wireless services.



Do not use the device if the display is cracked or broken. Broken glass or plastic can cause injury to hands and face. Send the device to our Service department to be repaired.



Keep small cells and batteries, which can be swallowed, out of the reach of children.

Swallowing a battery can lead to burns, perforation of soft tissue and death. Severe burns can occur within 2 hours of swallowing.

In the case of a swallowed cell or battery, seek medical care immediately.



Using your telephone may affect nearby medical equipment. Be aware of the technical conditions in your particular environment, e.g. doctor's surgery. If you use a medical device (e.g. a pacemaker), please contact the device manufacturer. They will be able to advise you regarding the susceptibility of the device to external sources of high frequency energy (for the specifications of your Gigaset product see "Technical data").

Working with the Gigaset N720 SPK PRO

The Gigaset N720 SPK PRO (Site Planning Kit) helps you to plan and install your DECT multi-cell system. It contains one measuring base station, two measuring handsets and further helpful accessories for exact determination of the DECT environmental conditions for the planned network, and is delivered in a case.

You can use the measuring devices in the case to determine the DECT wireless coverage at your location, establish how many base stations are required and their optimum location and find sources of interferences in the wireless network.



Detailed information on planning a multicell system and performing measurements to find the optimum positions for the base stations can be found in the Gigaset N870 IP PRO Site Planning and Measurement Guide.

Checking the package contents

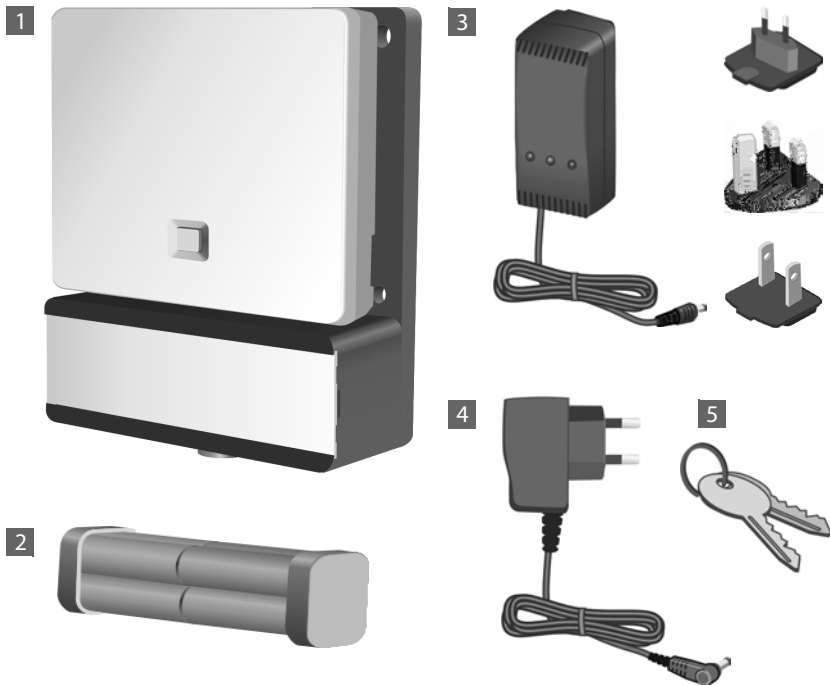

Further recommended accessories

Stand

To obtain an exact measurement, we recommend that you mount the measuring base station and battery carrier securely on a stand. The base carrier is fitted with a thread connection for this purpose. This enables you to simulate the installation of a base station at every possible height and check the layout and range of the network.

The stand should have a screw thread and be extendable to a height of 2.50 to 3.00 m.



Before you begin

Please note that the measuring devices run on batteries that must be charged before you start taking measurements. Bear this in mind when planning your time.

You need eight batteries for the measuring base station, provided as a battery pack. The case contains a charging device for charging the battery pack. The charging time is approximately 3 hours.

You need two batteries for each measuring handset. These can be charged in the chargers and in standard charging devices. The charging time in the charger is approx. 5 hours.



Only use rechargeable batteries (→ P. 18) recommended by Gigaset Technologies GmbH, i.e., never use conventional (non-rechargeable) batteries, otherwise serious health risks and personal injury cannot be ruled out. For example, the outer casing of the batteries could be damaged or the batteries could explode. The device could also malfunction or be damaged as a result of using batteries that are not of the recommended type.

Setting up the measuring base station

To ensure freedom of movement when measuring and not be dependent on being able to reach a power connection, operate the measuring base station with external batteries. The case contains a battery pack with eight integrated batteries and one charging device for this purpose.

Preparing the base carrier

- ▶ Remove the base carrier from the case together with the measuring base station and battery pack.
- ▶ Slide the lid to the left to open the battery compartment **1**.
Lift the lid gently with your fingernail to get past the lock on the right edge.



- ▶ Plug the connector on the battery pack cable onto the two pins on the left side of the battery compartment **2**.

Note: The connector is shaped so that it can only be attached the correct way round. If the connector is forced into the wrong position, the pins may be damaged, rendering the device unusable.

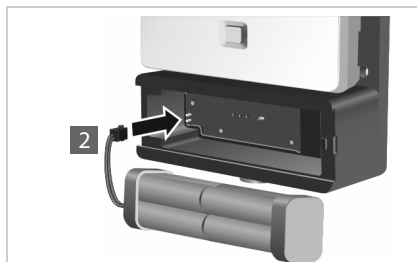

- ▶ Insert the battery pack into the battery compartment in the base carrier **3**.
- ▶ Slide the lid onto the battery compartment **4** until it clicks into place.

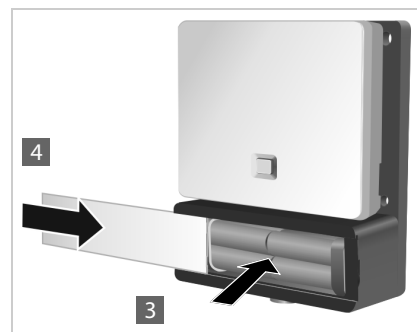

Charging the batteries

The measuring base station is connected to the power supply by means of a cable [1].

The charging socket is located behind opening [2], while there is a switch for switching between "Operation" and "Charge" behind opening [3].

- ▶ Move the switch to the charging position by sliding it towards the charging socket.

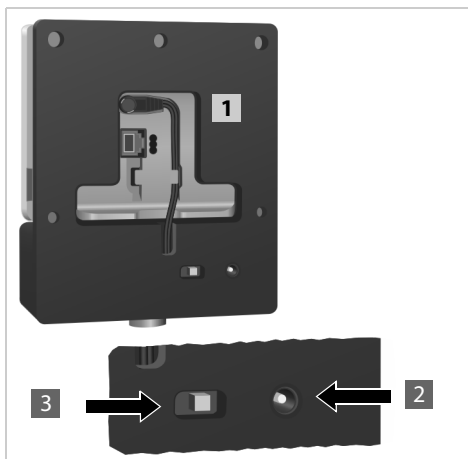

- ▶ Plug the battery charger into a mains socket [4].

You may need to attach the appropriate plug-in module first.

- ▶ Plug the battery charger plug into the charging socket on the back of the base carrier [5].
- ▶ Charge the batteries until the charger's charging indicator lights up.
- ▶ When the batteries are charged, unplug the charger plug from the charging socket and return the switch to the "Operation" position.

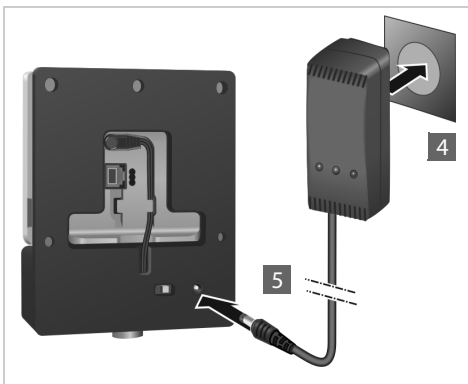

The measuring station has sufficient power when the LED on the front is illuminated.

To save energy, move the switch to "Charge" when you do not need the device.



Alternative power supply

The measuring base station is supplied with power via the battery pack inserted in the battery carrier. Alternatively, you can also use one of the following power supplies:

- ▶ Unplug the power cable plug from the base station.

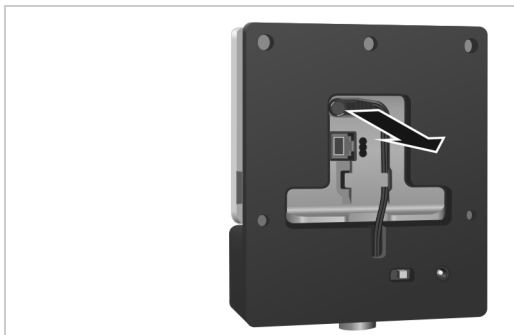

Connecting to the mains power supply

- ▶ Connect the cable for the power adapter provided to the power connection on the measuring base station **1**. Use the power adapter provided (no. **4**) in the figure on P. 4).
- ▶ Plug the power adapter into a mains socket **2**.

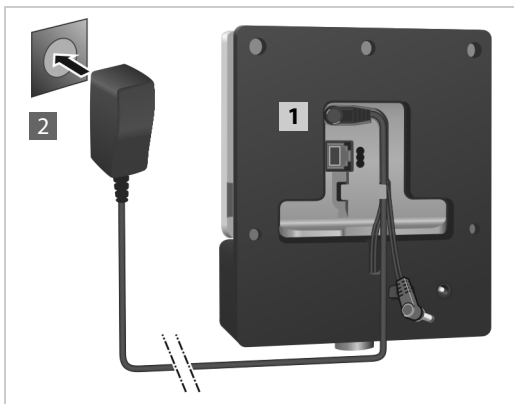

Connecting to a switch with PoE functionality (Power over Ethernet).

- ▶ Connect the LAN socket on the measuring base station **1** to a connection on an Ethernet switch **2**.

Use a shielded Ethernet cable.

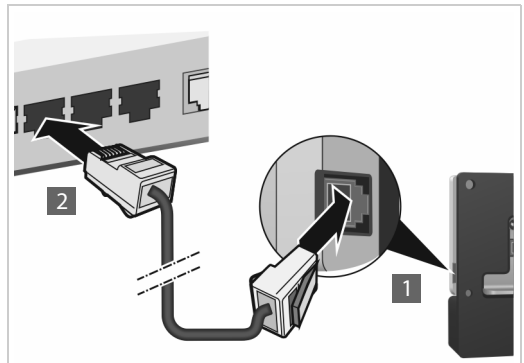

Mounting the measuring base station on the stand

The base carrier is fitted with a bracket for mounting the measuring base station on a stand.

- ▶ Position the thread of the battery carrier on the stand and screw the battery carrier into place.



Starting up the measuring handset

- ▶ Remove the measuring handsets and accessories from the case. For each handset there is:
 - 1 One charging cradle
 - 2 One power adapter
 - 3 One battery cover
 - 4 One belt clip
 - 5 Four batteries (AAA), of which two are spares

The display and keypad are protected by plastic film; **please remove it.**



Connecting the charger cradle

- ▶ Connect the flat plug of the power adapter to the charger **1**.
- ▶ Insert the power adapter into a mains socket **2**.

If you have to remove the plug from the charger again:

- ▶ Press the release button **3** and disconnect the plug.

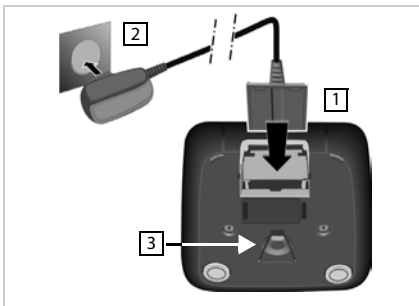

Inserting the batteries and closing the battery cover

- ▶ Insert the batteries with the polarity in the correct direction. The polarity is indicated in/on the battery compartment.
- ▶ Insert the battery cover from the top.
- ▶ Then press the cover until it clicks into place.

To open the battery cover; for example, to change the batteries:

- ▶ Insert your fingernail into the notch on the casing (see arrow), then pull the battery cover in an upward direction.

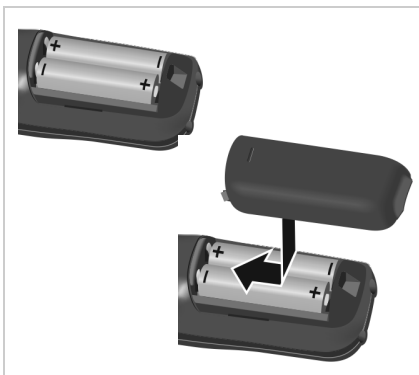

Initial charging and discharging of the batteries

The correct charge status can only be displayed if the batteries are fully charged and discharged first.

- ▶ Charge the handset in the charger for 5 hours.
- ▶ After charging, remove the handset from the charger and only replace it when the batteries are **fully discharged**.







The handset may only be placed in the associated charging cradle.



Battery charging status in the display

The charging status of the battery is shown in the top right corner of the display:



	Lights up white	Charged over 66%
	Lights up white	Charged between 34% and 66%
	Lights up white	Charged between 11% and 33%
	Lights up red	Less than 11% charged
	Flashes red	Battery almost flat (less than 10 minutes of operating time)
	Lights up white	Battery is charging

Connecting a headset to the handset

To assess the quality of the sound transmitted from the measuring station, you can connect headsets to the measuring handsets.

The connection for one of the headsets delivered is on the left side of the measuring handset.

This also means that your hands are free to enter the locations determined in the plan and you can read the display during the measurement phase.

The headset volume corresponds to the setting for the receiver volume.



Operating the measuring handset



This section only describes the functions of the handsets relevant for measurements. For information on the standard functions of the Gigaset S650H PRO handset, see the user guide for the device. See the product page at gigasetpro.com.

The measuring handsets

- Switch on automatically when they are placed in the charger
- Are already registered to the measuring base station on delivery
- Are already in metering mode on delivery.

Display in metering mode

In metering mode, the display shows the current status values of the connection to the base station. The values are updated at brief intervals. You can change this measuring interval (→ P. 15).

Display in idle mode

The display shows the following information in idle status:

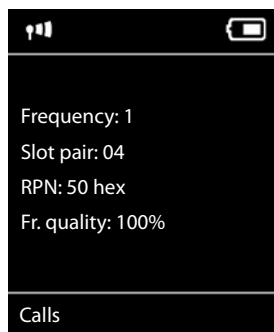

Values for determining the connection quality:

RSSI value **RSSI value.** Base station signal reception strength with the best reception in **dBm**.
Acceptable value: -20 to -70 dBm.
Units for signal strength → P. 15.

Fr. quality **Frame quality.** Percentage rate of the packages received without error in the last measuring interval.
Acceptable value: 95 – 100%

Otherwise the following information is displayed:

Frequency	Frequency. Carrier frequency of the signal received. Value range: 0 – 9.
Slot pair	Duplex Slot pair used (0 – 11) Time slot for the reception channel on which the measurement was performed. Note: During the transition in the connection status, value 15 is occasionally displayed.
RPN	RPN (Radio Fixed Part Number) ID of the base station to which the handset is connected. The value is displayed in hexadecimal format.

You will find detailed information on evaluating the measurement results in the Gigaset N870 IP PRO Site Planning and Measurement Guide.

Display not in idle mode

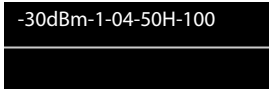

-30dBm-1-04-50H-100

If the display is not in idle status, it shows the measurement data at the top edge.

Checking the quality of the connection to the measuring base station

Connecting the measuring handsets

If two people perform the measurements, you can check the voice quality by establishing a connection between the two measuring handsets.

The handsets are in metering mode in idle status.



Initiate internal call.



Enter the internal number of the other handset using the keypad.

or:



Initiate internal call.



Select handset. Your own handset is identified by a "<" on the right.



Press the talk key.

Calling all handsets



Press and **hold**.

Switching on the continuous test tone for the base station

If you perform the measurements alone, you can play a continuous test tone to test the connection to a measuring base station from a measuring handset.



Enter the number string from the keypad.



Press the talk key.

The test melody is played via the loudspeaker. If you have connected a headset, press the speaker key  to hear the melody.

Activating/deactivating the measuring handset

The measuring handset is activated automatically when it is placed in the charger. This means that it is activated after charging in the charger.



With the phone in idle status, press and **hold** the end call key (confirmation tone) to deactivate the handset. Press and **hold** the end call key again to reactivate the handset.

Switching the handsfree function on/off

You can also test the quality of the connection via the loudspeaker instead of via the headset.



Press the speaker key to switch between earpiece mode and speaker mode.



- ▶ In this case, place the plastic cover supplied on the headset socket. This improves the quality in speaker mode.

Activating/deactivating metering mode

The handset is in metering mode when it is activated.

Exiting metering mode

You exit metering mode by resetting the handset:

 →  → System → Handset Reset





Reactivating metering mode via the service menu

If you have exited metering mode, you can reactivate it via the service menu. Proceed as follows:

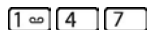

Press and **hold** the off key to deactivate the handset.



Press ,  and  at the same time and hold them down. Then press and hold the on key .



The handset is now in Service mode.



Enter the five-digit service PIN. On delivery this is 76200.

The service menu is opened.

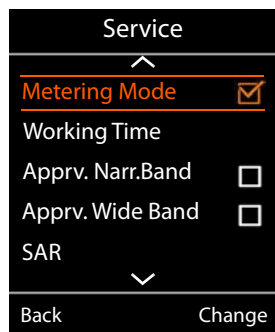

Select the **Metering Mode** entry with the navigation key.

Change

Press the display key to activate the entry.

Once you activate metering mode, the **RSSI measurement** menu is opened.

Here you can change the settings for the unit of measure and the measurement interval.

Changing the settings for metering mode

In the service menu, you can change the unit of measure and the measurement interval for metering mode.

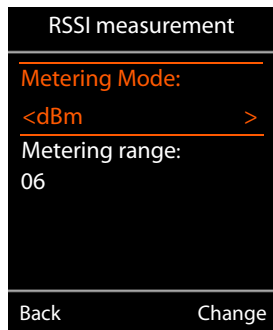

Metering Mode (unit of measure)

On the display, the signal strength (**RSSI value**) is shown in dBm as standard. You can also display the signal strength as a percentage value. This represents the signal strength of the package received as a ratio of the maximum possible RSSI (100%).



Use the navigation key to select the desired display of the signal strength.

dBm: The signal strength measured is displayed in dBm. This is preset and is the recommended mode.

%: The signal strength measured is displayed as a percentage of the maximum possible RSSI

SEN: Not relevant.

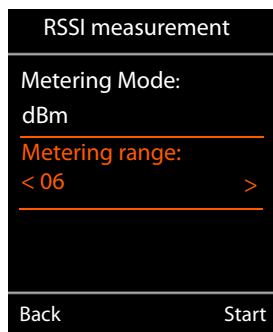

Metering range (measurement interval)

The measurement interval defines the time intervals at which measurements are taken.

Value range: 06 – 16 (1.0 s – 2.5 s)

Recommended value: 16



Use the navigation key to select the required measurement interval.

Start Press the display key to activate metering mode.

Back Press the display key to exit the service menu again.

The handset is deactivated. When you reactivate it, it is in metering mode with the selected settings.



You should not make changes to other settings in the service menu.

Customer service and help

Do you have any questions?

For quick help and information, please refer to this user guide or visit gigasetpro.com.

For online information and services concerning

- Products
- Documents
- Interop
- Firmware
- FAQ
- Support

please refer to wiki.gigasetpro.com.

For further information our Gigaset specialised reseller will be happy to help you related to your Gigaset product.

Questions and answers

If you have any queries about the use of your telephone, visit our website at gigasetpro.com.

Environment

Environmental management system



Gigaset Technologies GmbH is certified pursuant to the international standards ISO 14001 and ISO 9001.

ISO 14001 (Environment): Certified since September 2007 by TÜV SÜD Management Service GmbH.

ISO 9001 (Quality): Certified since 17/02/1994 by TÜV SÜD Management Service GmbH.

Disposal

All electrical and electronic products should be disposed of separately from the municipal waste stream via designated collection facilities appointed by the government or the local authorities.



This crossed-out wheeled bin symbol on the product means the product is covered by the European Directive 2012/19/EU.

The correct disposal and separate collection of your old appliance will help prevent potential negative consequences for the environment and human health. It is a pre-condition for reuse and recycling of used electrical and electronic equipment.

For more detailed information about disposal of your old appliance, please contact your local council refuse centre or the original supplier of the product.

Appendix

Approval

Voice over IP telephony is possible via the LAN interface (IEEE 802.3).

Depending on your telecommunication network interface, an additional router/switch could be necessary.

For further information please contact your Internet provider.

This device is intended for use worldwide. Use outside the European Economic Area (with the exception of Switzerland) is subject to national approval.

Country-specific requirements have been taken into consideration.

Hereby, Gigaset Technologies GmbH declares that the radio equipment type

Gigaset N720 SPK PRO - Gigaset S650H PRO is in compliance with Directive 2014/53/EU.

The full text of the EU declaration of conformity is available at the following internet address: www.gigaset.com/docs.

This declaration could also be available in the "International Declarations of Conformity" or "European Declarations of Conformity" files.

Therefore please check all of these files.

Care

Wipe the device with a **damp** cloth or an antistatic cloth. Do not use solvents or microfibre cloths.

Never use a dry cloth; this can cause static.

In rare cases, contact with chemical substances can cause changes to the device's exterior. Due to the wide variety of chemical products available on the market, it was not possible to test all substances.

Impairments in high-gloss finishes can be carefully removed using display polishes for mobile phones.

Contact with liquid

If the device comes into contact with liquid:

- 1 **Disconnect the power supply.**
- 2 Allow the liquid to drain from the device.
- 3 Pat all parts dry.
- 4 Place the device in a dry, warm place **for at least 72 hours (not in a microwave, oven etc.)** with the keypad facing down (if applicable).
- 5 **Do not switch on the device again until it is completely dry.**

When it has fully dried out, you will normally be able to use it again.

Technical details

Handset batteries

Technology	Nickel metal hydride(NiMH)
Size	AAA (Micro, HR03)
Voltage	1.2 V
Capacity	700 mAh

Each handset is supplied with four recommended batteries.

Operating times/charging times for batteries

The operating time of your Gigaset devices depends on the capacity and age of the batteries and the way they are used (all times are maximum times).

Battery pack for the measuring base station

Capacity	2000 mAh
Usage time	5.8 hours
Charging time in charger	3 hours

Base station mains unit

Manufacturer	Salom Electric (Xiamen) Co. Ltd. Commercial registration number: 91350200612003878C 31 Building, Huli Industrial District, Xiamen, Fujiam361006, P.R. China
	Salcomp (Shenzen) Co. Ltd. Commercial registration number: 91440300618932635P Salcomp Road, Furond Industrial Area, Xinqiao, Shajing, Baoan District, Shenzen 518125 China
Model identifier	EU: C557 UK: C608
Input voltage	230 V
Input AC frequency	50 Hz
Output voltage	6,5 V
Output current	0,6 A
Output power	3,9 W
Average active efficiency	> 76,1%
Efficiency at low load (10%)	not relevant - only at output power > 10 W
No-load power consumption	< 0,1 W

Handset mains unit

Manufacturer	Salom Electric (Xiamen) Co. Ltd. Commercial registration number: 91350200612003878C 31 Building, Huli Industrial District, Xiamen, Fujiam361006, P.R. China
	Salcomp (Shenzen) Co. Ltd. Commercial registration number: 91440300618932635P Salcomp Road, Furond Industrial Area, Xinqiao, Shajing, Baoan District, Shenzen 518125 China
Model identifier	EU: C705 UK: C710
Input voltage	230 V
Input AC frequency	50 Hz
Output voltage	4 V
Output current	0,15 A
Output power	0,6 W
Average active efficiency	> 46 %
Efficiency at low load (10%)	not relevant - only at output power > 10 W
No-load power consumption	< 0,10 W

Accessories

Ordering Gigaset products

You can order Gigaset products from your specialist retailer.

Case with measuring equipment	Part number
Gigaset N720 SPK PRO	S30852-H2316-R101

Spare parts for the Gigaset N720 SPK PRO

Spare part
Measuring base station Gigaset N720 SPK PRO
Base carrier
Battery pack/base station
Charging device/base station
Calibrated Gigaset S650H PRO measuring handset
Headset

Index

A	
Approval.....	17
B	
Base carrier.....	6
mounting on the stand.....	9
Batteries	
charging.....	8
inserting in handset.....	10
Battery charge status, handset.....	11
Battery charger.....	7
Battery compartment cover, handset.....	10
Battery pack	
charging.....	7
inserting in the base carrier.....	6
Broken display.....	3
C	
Care.....	17
Care of the device.....	17
Carrier frequency.....	12
Charging socket.....	7
Contact with liquid.....	17
Contents.....	4
Customer service.....	16
D	
Display	
broken.....	3
in idle mode.....	12
in metering mode.....	12
not in idle mode.....	13
Disposal.....	16
E	
Emergency numbers	
not possible.....	3
Environment.....	16, 19
F	
Frame quality.....	12
G	
Gigaset N720 SPK (Site Planning Kit).....	4
H	
Handsfree mode.....	13
Headset	
connect.....	11
L	
Liquid.....	17
Looking after the phone.....	16
M	
Measurement interval.....	15
Measuring base station	
LED.....	7
mounting on the stand.....	9
setting up.....	6
Measuring base station, power supply	
via battery pack.....	7
via mains power supply.....	8
via PoE.....	9
Measuring equipment.....	4
Measuring handset	
accessories.....	10
activating/deactivating.....	13
battery charge status.....	11
charging batteries.....	11
connecting.....	13
connecting charger.....	10
connecting headset.....	11
inserting batteries.....	10
operating.....	12
starting up.....	10
Medical equipment.....	3
Metering mode	
%.....	15
dBm.....	15
display.....	12
exiting.....	14
reactivating.....	14
O	
Opening the battery compartment.....	6
P	
Playing test melody.....	13
PoE (Power over Ethernet).....	9
Power adapter.....	3, 8
Q	
Questions and answers.....	16
R	
Readings	
display on handset.....	12
RSSI.....	15

S	
Safety precautions	3
Service menu	14
Service mode	14
Signal strength	12
change unit of measure	15
Slot pair	12
Stand	5
mounting	9

T	
Time slot	12
Troubleshooting	16

Issued by

Gigaset Technologies GmbH
Frankenstr. 2, 46395 Bocholt, Germany

© Gigaset Technologies GmbH 2024

Subject to availability.

All rights reserved. Rights of modification reserved.

www.gigaset.com