

# Gigaset pro



## Maxwell 4

BECAUSE IT'S YOUR BUSINESS.

# Contents

<b>Overview</b> .....	<b>3</b>
Keys .....	3
Connections .....	5
Illustration in the user guide .....	6
<b>Safety precautions</b> .....	<b>8</b>
<b>Using the telephone</b> .....	<b>9</b>
Getting to know your telephone .....	9
Making calls .....	16
Call lists .....	27
Message Centre .....	29
Voice mails .....	30
Directories .....	31
<b>Settings</b> .....	<b>36</b>
Basic settings .....	36
Configuring other settings with the Web configurator .....	42
Status of the telephone .....	53
<b>Appendix</b> .....	<b>54</b>
Customer Service & Help .....	54
Manufacturer's advice .....	54
Menu tree .....	58
Display icons .....	59
<b>Index</b> .....	<b>61</b>



If the telephone is connected to a telephone system, the telephone system can have a bearing on the telephone functions or block or add to them.

Further information: → User guide for the telephone system

This guide is aimed at telephone users.

Information for administrators: → [wiki.gigasetpro.com](http://wiki.gigasetpro.com)



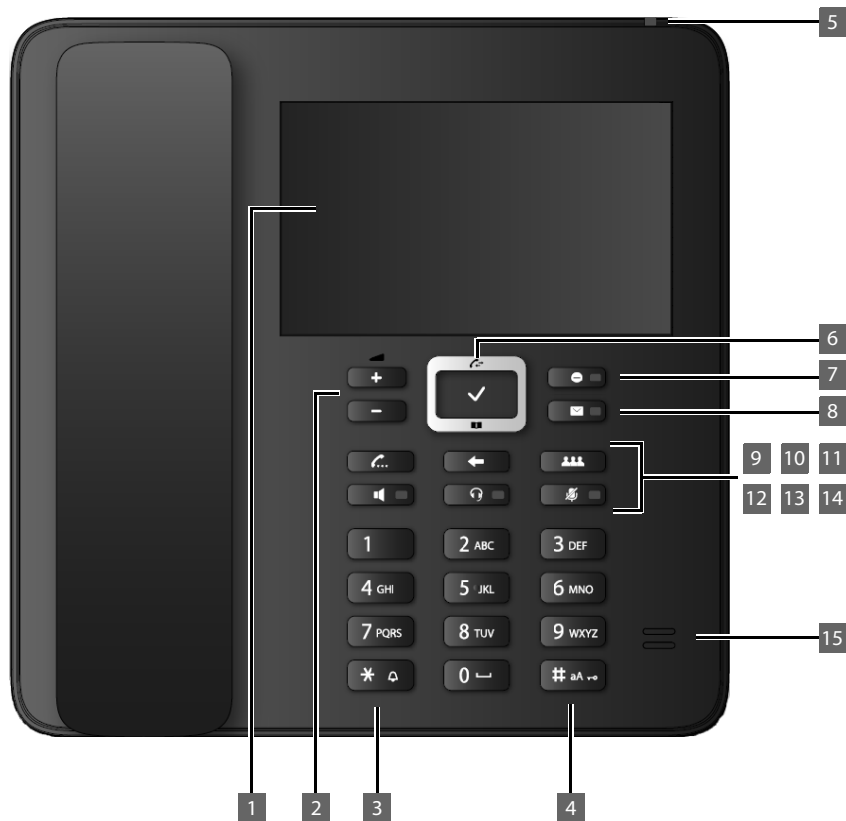

# Overview

## Keys









1	<b>Touch screen</b>	Activate the display key functions	→ page 9
2	<b>Volume keys</b>	Depending on the operating mode: Adjust the volume of the speaker, receiver, headset or ringtone	→ page 21
3	<b>Star key</b>	Display special characters when inputting text Activate/deactivate the ringtone	→ page 14 → page 20
4	<b>Hash key</b>	Switch text mode (upper/lower case letters, digits) Lock/unlock the keypad	→ page 14 → page 15

## Keys

5	<b>Status LED</b> 	Status display for incoming calls Flashes: Incoming call Lights up: Call in progress	
6	<b>Control key</b>	Scroll through lists and entries. In idle status:  Open the call list  Open the menu  Open the directory	→ page 12 → page 27 → page 13 → page 31
7	<b>Do Not Disturb key</b>	Activate/deactivate Do Not Disturb (DND) Lights up: "Do Not Disturb" function is activated	→ page 20
8	<b>Message Centre</b>	Open call and message lists Flashes: New message in the Message Centre	→ page 27
9	<b>Consultation call key</b>	Initiate/end consultation call; put participant on hold	→ page 24
10	<b>End/back key</b>	Cancel function; go back one menu level (press <b>briefly</b> ); return to idle status (press <b>and hold</b> )	→ page 13
11	<b>Conference call key</b>	Initiate conference call	→ page 24
12	<b>Handsfree key</b>	Activate/deactivate speakers Start dialling Lights up: Call is being made via the speaker (handsfree mode)	→ page 21 → page 16
13	<b>Headset key</b>	Make call via headset Start dialling Lights up: Call is being made via the headset	→ page 16
14	<b>Mute key</b>	Activate/deactivate microphone (mute) Lights up: The microphone is muted	→ page 21
15	<b>Microphone</b>	Microphone of the handsfree unit	



## Connections















- 1  Expansion module with additional function keys
- 2  LAN (PoE)
- 3  PC; a PC can also be connected to the telephone instead of to the local network, the telephone establishes the network connection
- 4  Receiver
- 5  Headset with RJ9 plug
- 6 **EHS** EHS headset (Electronic Hook Switch)
- 7  Power adapter
- 8  USB; to connect for example a USB stick with a directory or a Bluetooth headset

## Illustration in the user guide

### Icons



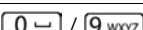

	Important information regarding function and appropriate handling or functions that could generate costs.
	Prerequisite for carrying out the following action.
	Additional helpful information.













### Keys

	Handsfree key		Do not disturb key
	Headset key		Message key
	End/Back key		Volume keys
	Conference call key		Hash key
	Consultation call key		Star key
	Mute key		Digit/letter keys
	Control key rim / centre		

## Procedures

**Example:** Setting the display language

- ▶  ▶  **Settings** ▶  **Language** ▶  Select the language ▶  Select  
 (◉ = selected)

Step	Actions required
▶ 	Press the <b>middle</b> of the control key when the handset is in idle mode. The main menu is opened.
▶  <b>Settings</b>	Tap  <b>Settings</b> or use the Control key  to select <b>Settings</b> and press  . The <b>Settings</b> submenu is opened.
▶  <b>Language</b>	Scroll through the menu entries by swiping up or down, or by using the Control key. Tap <b>Language</b> or press the Control key  . The <b>Language</b> submenu is opened.
▶  Select language	Scroll to the required language by swiping up or down, or by using the Control key.
▶  Select	Next to the required language, tap symbol  or press the Control key  . The option selected is denoted by  .

## Safety precautions



Read the safety precautions and the user guide before use.

**Comprehensive user guides for all telephones and telephone systems as well as for accessories can be found online at [gigasetpro.com](http://gigasetpro.com) in the Support category. We thereby help to save paper while providing fast access to the complete up-to-date documentation at any time.**

The device cannot be used in the event of a power failure. In case of a power failure it is also **not** possible to make **emergency calls**.

Emergency numbers **cannot** be dialled if the **keypad/display lock** is activated!



Do not use the devices in environments with a potential explosion hazard (e.g. paint shops).



The devices are not splashproof. For this reason do not install them in a damp environment such as bathrooms or shower rooms.



Use only the power adapter indicated on the device.



Remove faulty devices from use or have them repaired by our Service team, as these could interfere with other wireless services.



To connect the phone to the local network and PC only use shielded cables.

### Data protection notice

When the device is connected to the router, it will automatically contact the Gigaset Support Server. It will send the following device-specific information daily:

- Serial number / Item number
- MAC address
- Private IP address for the Gigaset in the LAN, its port numbers
- Device name
- Software version

On the support server, this information is linked to the existing device-specific information:

- System-related / Device-specific passwords



# Using the telephone

## Getting to know your telephone

### Display

The display of the Gigaset Maxwell 4 is realised as a touch screen. The phone is operated by directly touching the display (swiping or tapping) or from the Control key on the phone.

When the phone is in idle mode, it is possible to switch between four display screens:

- A start screen with access to important phone functions
- Two screens with function keys, right (→ page 10)
- One screen with information on calls and incoming messages, on very left (→ page 11)

Switching between the idle display screens:

- ▶  Swipe left or right or press the Control key left or right

### Start screen (example)

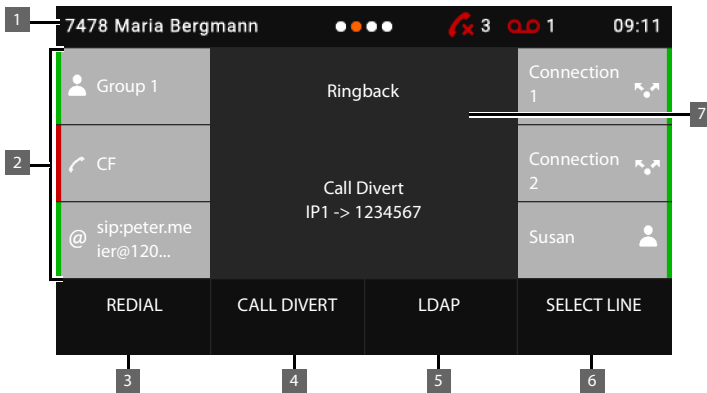

- 1 Status bar
- 2 Three function keys each on the left and right → page 10
- 3 Open the redial list → page 17
- 4 Set up call forwarding, enable/disable → page 25
- 5 Open company directory (if configured) → page 34
- 6 Select the line for the next call → page 16
- 7 Information area: displayed here for example is an incoming call or when call forwarding is active or a ringback has been initiated.  
Change the background colour/image: → page 38

## Getting to know your telephone

### Status bar

All idle display screens have the same status bar.

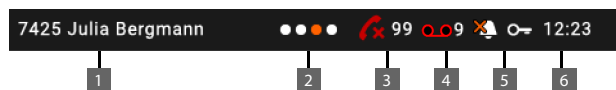

- 1 Name of the standard connection (is assigned by the administrator, e. g. extension and/or name of the phone user) → page 16
- 2 Position of the screen being displayed (orange dot)
- 3 Number of missed calls → page 27
- 4 Number of new voice messages → page 30
- 5 Status icons → page 59
- 6 Time → page 36











If a lack of space means not all status icons can be displayed, the display is alternate.

### Function keys

Programmable function keys offer rapid access to frequently used numbers and functions. A total of 38 function keys are available, six on the central start screen and 16 each on the two start screens on the right. The current assignment is shown on the start screens on the idle display.

To switch between the screens: ▶  Swipe left or right or press the Control key left or right

The function key grid is a 4x4 grid of buttons. The top bar shows '7425 Julia Bergmann', three dots, and '12:23'. The buttons are as follows:

 Connection 3	 Phillip Black	 August Zimmerman	
 Connection 4	 Group 2	 Susan Brown	
 Alexander Maxwell	 #62*	 @ Egon SIP	
 Benjamin Smith	 Answ. mach.	 @ Max SIP	







The number of function keys can be increased using an expansion module.

## Assigning function keys

Use the Web configurator to assign function keys: → page 49

The function keys are arranged on the display starting in the top left, from the top down and from left to right. They can be assigned the following functions:

Icon	Function
	Line
	Quick Dial, Park + Retrieve, BLF
	Call Divert, FAC, DTMF
	SIP URI
	SIP Info

For detailed function descriptions → page 49

It is possible to select colours for keys with functions **Line**, **BLF**, **SIP Info** and **FAC**. A colour indicates, on the left-hand side of a key, whether the function is active or not.

For key assignments **Line** and **BLF**, the **Standard** selection means:

Yellow Not registered with the provider / phone system, or error

Green Free

Permanently red Conversation ongoing

Flashing red Incoming call

## Event list

The event list is displayed as the left-hand side of the idle display.

► From the start screen, swipe right or press the Control key left .

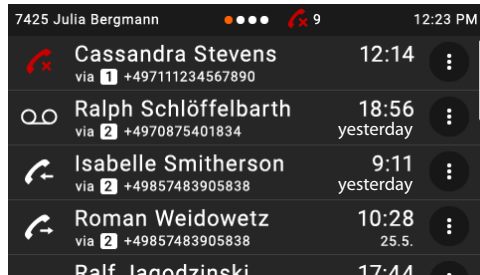

The list contains all entries in the call lists (incoming, outgoing and missed calls) and messages on the answering machine.

For additional information



- about the call lists → page 27
- about voice messages → page 30

## Control key



The Control key enables you to navigate the menus and input fields, and also to call up certain functions depending on the situation.

Most functions can also be performed by touching the touch screen.

In the description below, the side of the Control key (up, down, right, left) that you have to press in the different operating situations is marked in black, e. g.  for "press right on the Control key" or  for "press the centre of the Control key".

### In idle status

Open the main menu



Open the call lists



Open the directory assigned to the key

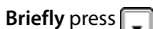

Open the list of available directories

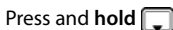

Scroll through the idle display screens

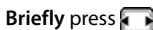

### In submenus and lists and selection fields

Select/confirm function



Scroll one line upwards/downwards

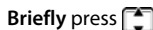

Scroll the list upwards/downwards

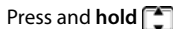

### In input fields

Moves the cursor to the left/right one character at a time

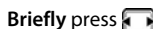

### During a conversation

Open the directory

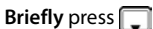

Open the list of available online directories

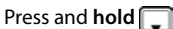

## Menu navigation

The functions of the telephone are displayed in a menu that consists of several levels.  
Menu overview → page 58

### Main menu

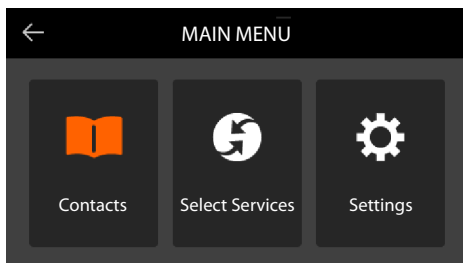

In idle mode: ▶ Press the **centre** of the Control key 

The functions of the display menu are displayed each with their icon.



The icon for the submenu selected is shown orange.

Select submenu:

- ▶ Tap the submenu, or select the submenu using the Control key  and press the middle of the Control key 

### Submenus

The functions in the submenus are displayed as lists. The selected function is highlighted.

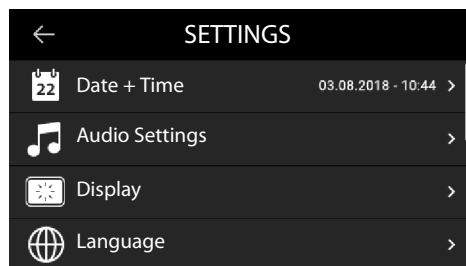

To select a function:



- ▶  Swipe up or down, or scroll through the list using the Control key

To open a submenu:

- ▶ Tap the submenu or press the Control key 

If not all functions can be displayed, you will see a scroll bar on the right-hand side.

### Returning to the previous menu level

- ▶ Tap  or press the End key 

## Getting to know your telephone

### Returning to idle status

- ▶ Press and **hold** the End key 



If no key is pressed, the display **automatically** switches to idle mode after about 3 minutes.

Settings which have not been saved or confirmed are rejected.

---

## Entering text



### Input position

- ▶ Use  to move the position of the cursor.

### Correcting incorrect entries

Delete **characters** to the left of the cursor: ▶ 

### Entering letters/characters

Multiple letters and digits are assigned to each key between  and  and the  key. As soon as a key is pressed, the possible characters are displayed at the bottom of the display.

The selected character is highlighted.

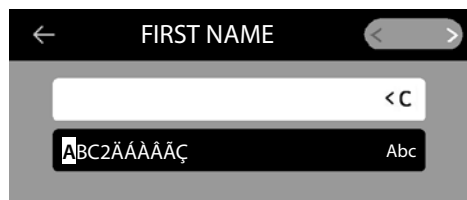



Select letters/digits:

- ▶ Press the key **briefly** several times in succession

Switch between lower case, upper case and digit entry mode:

- ▶ Press the Hash key  ... the mode set is displayed on the right in the black field  
When editing a directory entry, the first letter and each letter following a space is automatically in upper case.

Entering special characters:

- ▶ Press the Star key  ... the available special characters are displayed ▶ Tap the character required, or use  to navigate to it and confirm it with .

## Locking/unlocking the keypad

The keypad lock prevents any accidental use of the telephone.

Locking the keypad: ▶ Press and **hold**  ... the following icon appears on the display 

Unlocking the keypad: ▶ Press and **hold**  ▶  Enter the PIN for the keypad lock (default: 1234) ▶ **OK**



Changing the keypad lock PIN with the Web configurator: → page 42

If a call is indicated on the handset, the keypad automatically unlocks and you can accept the call. It then locks again when the call is finished.

It is not possible to call emergency numbers either when keypad lock is activated.

## Making calls



The phone is connected to the LAN.

At least one VoIP connection has been set up and assigned to the telephone.



VoIP connections are set up by the administrator with the Web configurator or assigned using a PABX.

Up to six VoIP connections (call numbers) can be assigned to the phone. The first connection to be set up is the standard send connection. The name of the standard send connection is displayed in idle mode in the top left in the status bar (→ page 9).

No connection available: the following icon is shown in the display

Information about the telephone connections and the standard send connection: Web configurator → page 53

## Making a call

▶ Enter the number ▶ Lift the handset

or

▶ lift the handset ▶ Enter the number ▶ **DIAL**

Use + as a prefix for calls abroad: ▶ Press and hold key

Calls are initiated via the standard send connection if you do not select another option. To use another VoIP connection:

▶ **SELECT LINE** ▶ select required connection ▶ Enter the number ▶ **DIAL**

Using the speaker to make calls: ▶ Enter the number ▶ Press the handsfree key

Using the headset to make calls: ▶ Enter the number ▶ Press the headset key



You can switch over at any time during the conversation.

In the following instructions, the icon also always stands for or .

When entering the call number:

Deleting incorrectly entered numbers to the left of the cursor: ▶

Cancel dialling: ▶ **END**

Incoming call during number entry:

Accept the call: ▶ **ACCEPT**

Reject the call: ▶ **REJECT**



## Dialling from the directory

▶  Open the directory ▶  select entry ▶  lift the handset

or

▶  ▶  **Contacts** ▶ **OK** ▶  select entry ▶  lift the handset

More than one number in the directory entry: ▶  Select the phone number

## Dialling from the redial list

The redial list contains the most recently dialled numbers.





▶ In idle status press **REDIAL** ▶  select entry ▶  lift the handset

or

▶  Open the call lists ▶  **OUTGOING** ▶  select entry ▶  lift the handset

## Dialling from a call list

The call lists contain the most recent accepted, outgoing and missed calls (→ page 27). If the number is saved in the directory, the name is displayed.

▶ Use  to open the call lists ▶  select a list (**ALL, ACCEPTED, MISSED, OUTGOING**) ▶  select entry ▶  lift the handset





The list of new missed calls can also be opened by pressing the Message key .

## Dialling with quick dial keys

Keys 1 to 4 on the phone can be assigned a phone number, that is then dialled with one keypress.



Assign quick dial key from the Web configurator: → page 48

▶ Press and **hold** quick dial key  –  **GHI** ... the number saved for the key is dialled, the handsfree function or the headset is enabled

## Dialling a number using a function key

Dialling numbers with one press of a function key.



A quick dial number is assigned to the function key.

Assigning numbers to function keys: Web configurator (→ page 49)

▶ Press the function key assigned the required number ... the number saved for the function key is dialled, the handsfree function is activated

---

### Ringback

Asking for a ring back when the line of a participant you have called is busy.



The PABX or the provider supports this function.

### Initiating ringback

- ▶ **RINGBACK** . . . the ringback request is registered, **Ringback** and the phone number are shown on the display

When the other participant's line is free, the ringback is initiated. The telephone rings, **Ringback** is displayed in the header.

There can be an active ringback on each line.



---

### Anonymous calling

Withhold Calling Line Identification. The number is not shown to the person receiving the call.



The PABX or the provider supports this function.

- ▶  ▶  **Select Services** ▶ Enable the switch next to **Withhold Number**  
( = the connection is established without Calling Line Identification)

## Incoming calls

An incoming call is indicated by ringing, by a display on the screen and by the flashing Status LED.

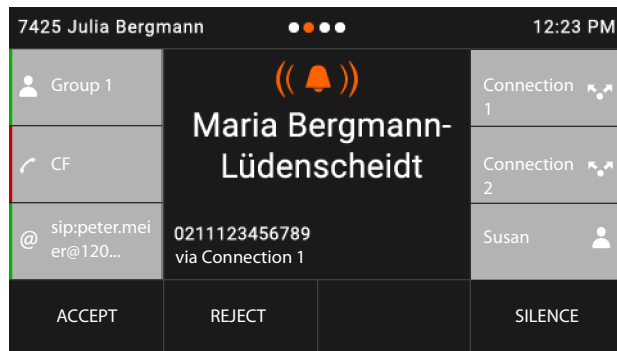

The display shows

- the caller's name if it has been stored in the directory
- the caller's number if it has been sent
- the line on which the call is coming in
- a picture of the caller, if one has been transmitted (CNIP)

Accepting the call: ▶  Lift the handset

or

▶ **ACCEPT** ... the call is accepted using the handsfree function

Switch the ringtone off: ▶ **SILENCE**

Rejecting the call: ▶ **REJECT**



If the call is a ringback, **Ringback** is shown on the display.

When a call comes in, the system looks for a matching entry in the local directory. If the number is not found there, other directories are searched, if any have been configured.

## Protection from incoming calls

---

### Activating/deactivating the ringtone

An incoming call is not signalled by ringing, but is displayed on the screen.

Switching the ringtone on/off: ▶ Press and **hold** the Star key 

Ringtone is switched off: the following icon appears on the display 



Ringtone silencing for anonymous calls: → page 37

---

### Switching the "Do not disturb" function on and off

Incoming calls are not signalled.

Switching "Do not disturb" on or off: ▶ Press the Do not disturb key 

"Do not disturb" is switched on: the Do not disturb key  is illuminated, the display shows **"Do not disturb" active**



Set up call forwarding: → page 25

The administrator can create a list of numbers which should never be signalled by the telephone in the Web configurator.

## During a conversation

### Changing the volume

Changing the volume of the handset, the handsfree function or the headset during a call.

Louder:  ▶ Save

The volume can be set at 10 levels.

Quieter:  ▶ Save

The current setting is displayed.

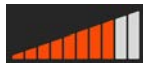

If there is no input for two seconds, the most recent value is stored automatically.



Permanent volume settings: → page 37

### Muting

Switching off the microphone in the handset, the handsfree facility and the headset. The other party to the call no longer hears what is being said.

Activating/deactivating the microphone: ▶ Press the Mute key 

Microphone is switched off: the Mute key  is illuminated

### Switching the handsfree function on/off

Making calls via the speaker and the microphone of the handsfree function.

Switching on the handsfree function during a call:

▶ Press the Handsfree key  ▶ Replace handset 

Handsfree function is switched on: the  key is illuminated

Switching off the handsfree function during a call:

▶ Lift the handset  ▶ continue the call through the handset

### Ending a call

▶ Replace the handset  or END

---

# Talking with several participants on the telephone

---

## Accepting/rejecting Call Waiting



The PABX or the provider supports this function and the function is activated on the telephone (→ page 44).

Another call comes in during a conversation. The call is signalled in the display and by the Call Waiting tone. The second call is shown on the display.

Accepting the call:



- ▶ Tap the call display ▶ **ACCEPT** ... the connection to the waiting participant is established. The first participant is put on hold and hears some on-hold music.

Rejecting the call:

- ▶ Tap the call display ▶ **REJECT**

## Permit/prevent Call Waiting

Permit or prevent Call Waiting during a call for all or for certain lines.

- ▶  ▶  **Select Services** ▶ Enable the switch next to **Call Waiting** (  = call waiting is permitted)



Define settings for Call Waiting with the Web configurator → page 44

---

## Two simultaneous incoming calls

When there are two simultaneous incoming calls, both are shown on the display.

- ▶  Select the call you want to accept ▶  Pick up the receiver ... the required connection is established

The other call is handled as a waiting call.

---

## Consultation calls

Consulting a second participant during a conversation.

- ▶ Press the Consultation call key 

or

- ▶ Tap **CONSULTATION**

... the first conversation is put on hold

- ▶ Initiate a consultation call from the keypad, from the directory, from the call list or using a function key

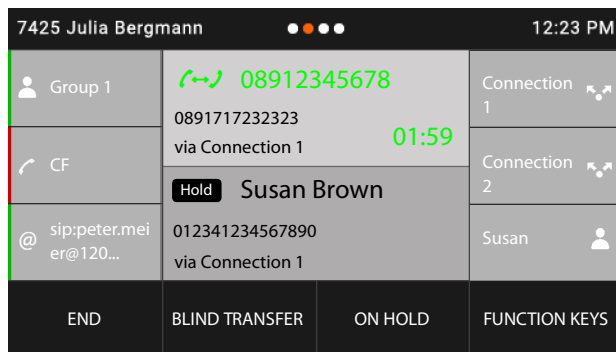

Ending a consultation call:

- ▶ **END** ... the connection to the person on hold is reactivated

Connect the parties to each other:

- ▶ Replace the handset 





or

- ▶ select the call on hold ▶ **Transfer** ... the call on hold is transferred to the consultation party.

If the consultation party does not accept the call, a recall is initiated by the party on hold (your phone rings). If you accept the call, you will be reconnected to the participant previously on hold.

### Initiating a consultation call from the directory or call list

During the conversation:

- ▶ Tap **CONSULTATION** or press the Consultation key  ... the call is put on hold
- ▶ **OPEN DIRECTORY/OPEN CALL LIST** ▶  Select the entry ▶  ▶  Select the number as required ▶  ... the number is dialled

### Initiating a consultation call from a function key





The number is stored on a function key, such as a quick dial number.

During the conversation:

- ▶ Tap **FUNCTION KEYS** ... the first screen with function keys is displayed ▶  Select another screen as required ▶ Tap the function key with the required number ... the number is dialled, the first call is put on hold

### Call swapping

Switch back and forth between two participants. The other call is placed on hold.

- ▶ Call a second participant during an external conversation (consultation call) or accept a waiting call ▶ Switch back and forth between the parties by tapping twice or with  ▶  Select the party

Ending the connection to the active participant:

- ▶ **END** ... the connection to the participant on hold is reactivated



Other ways of ending the call-swapping session:

- Replace the handset : The other two participants will be connected to one another.
- The **active** participant ends the conversation: The connection to the participant on hold is reactivated
- The participant **on hold** ends the conversation: The connection to the active participant remains active.

### Conference call

Speaking to two parties at the same time.

Initiating a conference call during a conversation:

- ▶ Press the Conference call key  ▶ call second party ... the conference is established as soon as the call is accepted

Initiating a conference from call swapping:

- ▶ Press the Conference call key  ... the active party and the party on hold are connected into the conference call

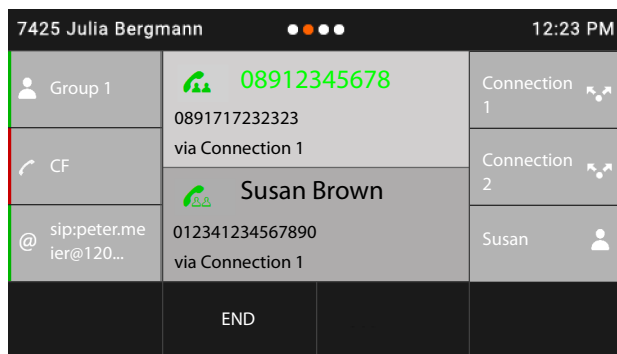

Removing a party from the conference call: ▶  Select the party ▶ **END**

Ending a conference call: ▶ Replace the handset  ... the conference call is ended for all parties



## Transferring a call

Forwarding a call to another external participant during the call:

- ▶ **BLIND TRANSFER** ▶ enter the number with the keypad or select from the directory ▶ **TRANSFER** ▶ replace the handset 

Connecting both external participants to one another during call swapping or in an external consultation call:

- ▶ select the call on hold ▶ **TRANSFER** ... the call on hold is transferred to the consultation party.

If the active participant does not accept the call, a recall will be initiated by the participant on hold.

## Call divert

Incoming calls are diverted to another line or a network mailbox. For every phone connection, you can set up call diverts for

<b>All Calls</b>	Calls are diverted immediately
<b>When Busy</b>	Calls are diverted if the line is busy
<b>No reply</b>	Calls are diverted if no one picks up after several rings



The PABX or the provider supports this function.

If calls are diverted to an answer machine, this must be set up by the administrator from the Web configurator.

### Activating call divert

- ▶ From the start screen, tap **CALL DIVERT**

or

- ▶  ▶  **Select Services** ▶  **Call Divert** ▶  Select a connection

- ▶ Select when call forwarding is to apply:

**All Calls / When Busy / No reply**

- ▶ Select where the call is to be forwarded:

To a phone number:

- ▶ **Phone Number** ▶ Tap the bottom of the entry field ▶ Enter the number ▶ **Save** ▶  Back

To the answering machine:

- ▶ **Voice Mail** ▶ **Save** ▶  Back ... calls are forwarded to the answering machine assigned to the connection

For call forwarding of type **All Calls**, the display shows in idle mode **Call Divert** as well as the connection and forwarding destination.



Call forwarding of type **No reply** becomes active after 120 seconds as standard. You can change the delay time from the Web configurator (→ page 44).





## Making calls

### Disabling call forwarding

For call forwarding of type **All Calls**:

- ▶ From the start screen, tap **CALL DIVERT**

For all types:

- ▶  ▶  **Select Services** ▶  **Call Divert** ▶  Select the connection ▶ Select the forwarding type (**All Calls / When Busy / No reply**) ▶ **Off** ▶  **Back**

If you assign a function key with the **Call Divert** function, you can enable and disable call forwarding using this function key.



Setting up call forwarding from the Web configurator: → page 44

Assigning function keys from the Web configurator: → page 49



## Call lists













The telephone saves different types of calls in lists. The following call lists are available:

<b>All Calls</b>	All outgoing, accepted and missed calls.
<b>Accepted Calls</b>	Calls that were accepted.
<b>Missed Calls</b>	Calls that were not accepted. Missed calls that have not yet been viewed can also be accessed via the Message key  (→ page 29).
<b>Outgoing Calls</b>	Last selected numbers (redial list).





If the call list is full, a new entry overwrites the oldest.

### Opening the call list





- ▶  ▶  Select list (**ALL, ACCEPTED, MISSED, OUTGOING**) ... The calls for the list type selected are displayed

←	ALL	ACCEPTED	MISSED	OUTGOING
	Susan Brown via  123456778987			10:15 
	Phil White via  203948572390857			20:13 yesterday 
	Alexander Abercrombie via  203948572390857			09:53 yesterday 
	089170987654 via  123456778987			16.09. 04.09. 

### Information about the calls





- Icon for the call type:
  -  Missed calls
  -  Accepted calls
  -  Outgoing calls
  -  Recordings on an answering machine
- Name of the caller if the number is stored in the directory
- Line over which the call was conducted
- Phone number of the caller or called party
- Date and time of the call

### Calling back a caller



- ▶  ▶  Select the list ▶  Select the entry ▶  Lift the receiver ... the number is dialled

---

## Copying a number to the directory

- ▶  ▶  Select the list ▶  Select the entry ▶ Tap  ▶ **Save Number ...** the directory is opened

Creating a new directory entry:

- ▶  **New ...** a form is opened for a directory entry, the phone number is entered with type **Office** ▶ Enter  **Name:** and **Surname:** ▶ If required, change the number type (**Office/Mobile/Home**) ▶ **Save ...** the entry is saved with the name specified and the phone number from the call list

Adding a number to an existing directory entry:

- ▶  Select the directory entry ... the number from the call list is added to the entry ▶ Select as required the number type (**Office/Mobile/Home**) ▶ **Save**





An error message is displayed if all number fields are assigned already. Delete as required old phone numbers.

 For more information about the local directory: → page 31

---

## Deleting entries

Deleting an entry:

- ▶  ▶  Select the list ▶  Select the entry ▶ Tap  ▶ **DELETE ENTRY**

Deleting all the entries in the list currently selected:

- ▶  ▶  Select the list ▶ Tap  ▶ **DELETE LIST**

## Message Centre

The Message Centre gives you quick access with a single key press to missed calls and voice mails on an answer machine.

The Message key  flashes if there are new messages. A missed call is considered new if it has been received since the **Missed Calls** list was last opened; a voice mail is considered new if it has not been listened to.



The administrator can use the Web configurator to specify which types of messages are accessible via the Message Centre.

Icons for message types and the number of **new** messages are shown in the status bar.





New messages:

 in the **Missed Calls** list (→ page 27)

 on a network mailbox (→ page 30)

The number displayed indicates the total for all the connections involved.

Opening the Message Centre:

- ▶ Press the Message key  ▶  Select the message type (**Voice Mail** or **Missed Calls**)

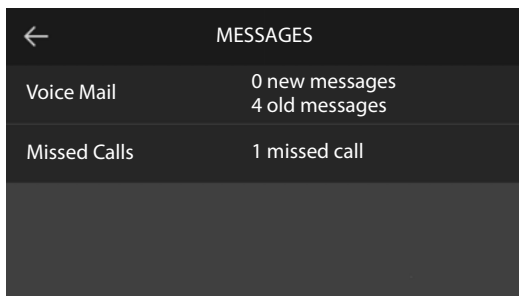

The **Voice Mail** list is always displayed, when an answer machine is stored in the telephone, the **Missed Calls** list only if it contains messages.



## Voice mails

Managing messages stored in a network mailbox. Every network mailbox accepts incoming calls on the corresponding VoIP phone number.



The administrator has entered the network mailbox(es) in the telephone with the Web configurator or there is an answer machine available with the PABX.

### Playing back voice mails

- ▶ Press the Message key  ▶  Select as required Answering machine (connection) ... all voice messages for the connection are displayed ▶  Select an entry ▶ **PLAY** ... the message is played over the phone speaker

Listening to messages through the handset:

- ▶  Lift the handset

Ending playback:

- ▶ Press the End Call key  or replace the handset 



An incoming call ends playback.

## Directories

The options are:

- Local directory
- Company directory (→ page 34)



The local directory is pre-set as a standard directory. This means that it is the directory that is opened with the Control key and into which entries are copied with the **Save Number** function (→ page 28).

The administrator can make another directory, such as the company directory, the standard directory.

## Local directory

### Opening the directory

In idle status:

- ▶ Press the Control key

or

- ▶ ▶ **Contacts**

The entries are shown in alphabetical order and are sorted by last name by default.

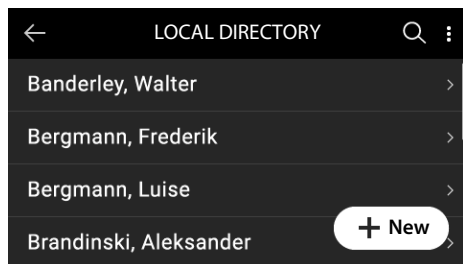

### Changing the sort order

- ▶ Tap ▶ **SORT BY FIRST NAME** or **SORT BY SURNAME**



If an entry does not include a name, the first phone number entered is stored and displayed as the last name.



---

## Displaying a directory entry

### Searching for an entry

▶  Swipe up or down, or press the up or down Control key

or

▶ Tap  ▶  Enter the initial letters of a name or digits of a phone number ... the entries matching the entry are displayed

### Opening an entry

▶ Tap the entry or press the Control key 

A directory entry can contain the following information

- First name and last name: (max. 32 characters each)
- Up to six phone numbers (max. 32 digits each)  
Two numbers each can be assigned to categories **Office**, **Mobile** and **Home**.
- Company name (max. 32 characters)

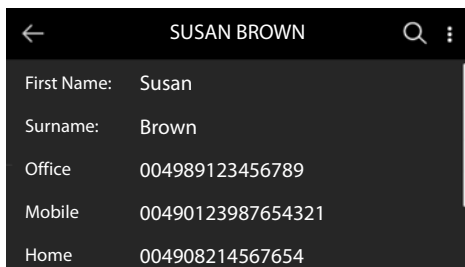

▶ Use  to scroll through the directory entry



---

## Creating a new entry

▶ Open the directory ▶ Tap  **New**

▶  Enter the name ▶ **Save**

or

▶  Select another field (**Surname:** or **Company:**) ▶  Enter the details ▶ **Save**

Entering phone numbers:

▶ Tap **Add Phone** ▶ Select the number category (**Office / Mobile / Home**) ▶  Enter the phone number ▶ **Save**

Saving a directory entry: ▶ **Save**



Creating a new entry with a number from the call list: → page 28

Information on entering text: → page 14





## Changing an entry

- ▶ Open the directory ▶ Open the entry ▶ **Edit** ▶  Select the entry field ▶ Delete old text as required, enter the new text ▶ **Save**

 Information on entering text: → page 14

## Dialling from the directory

- ▶ Open the directory ▶  Select an entry ▶  Lift the handset  
More than one number in the directory entry: ▶  Select the phone number

or



- ▶ Open the directory ▶  Select an entry ▶  Open the entry ▶  Select the phone number ▶  Lift the receiver or press the Control key 

Line selection for a call: ▶ Tap  ▶ Select the connection ... the call is initiated immediately over the connection selected

 Initiate a consultation call from the directory: → page 22

## Deleting directory entries

Deleting from the list the entries selected:

- ▶ Open the directory ▶ Tap  ▶ **EDIT LIST** ▶ Select one or more entries ( = selected) ▶ **Delete** ▶ Confirm the prompt with **Yes** ... the entries selected are deleted

Deleting the whole list:

- ▶ Tap  ▶ **EDIT LIST** ▶ Tap  ▶ **SELECT ALL** ▶ **Delete** ▶ Confirm the prompt with **Yes** ... all entries are deleted

---

## Using a company directory

If there is a directory available on your company's network, you can use it on the phone.



The administrator has set up and activated the directory in the Web configurator.

---

## Opening the company directory

In idle mode:

▶ Tap **LDAP**

or

▶ Press and **hold** the Control key  ▶ Select the company directory





The company directory is shown with the name specified by the administrator in the Web configurator.

---

## Searching for an entry

▶  Enter the search term

or

▶ Tap  ▶  Enter the name (i.e. its initial letters)

... the search process starts as soon as input is stopped. All the matching entries are displayed. If a matching entry is not found, the search field is redisplayed. You can launch a new search.

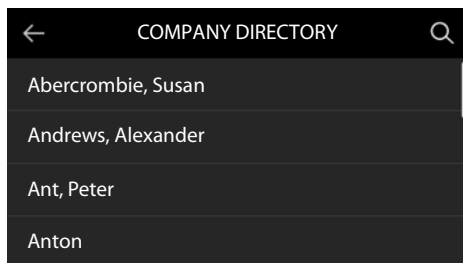

## Displaying an entry



- ▶ Search for the entry ▶ Tap the entry or press the Control key 

← ABERCROMBIE, SUSAN	
First Name:	Susan
Surname:	Abercrombie
Job:	CEO
Company:	Company
Office	004989123456789
Mobile	00490123987654321

A directory entry can contain the following information (depending on the information provided by the company directory):

Personal information:	<b>First Name; Surname; Job; Company:</b>
Numbers:	<b>Office, Mobile, Home</b>
Other contact details:	<b>Email; Web Address; Fax:</b>
Address information:	<b>Street; City; ZIP Code; Country:</b>

## Dialling a number from the company directory

- ▶  Select the entry ▶  Lift the receiver
- More than one number in the directory entry: ▶  Select the phone number

# Settings

The telephone is preconfigured. Individual settings can be modified via the display menu or on a PC using the Web configurator. Web configurator → page 42

## Basic settings

### Date and time



The address of a time server on the Internet or on the local network is stored on your phone. The date and time are taken from this time server provided that the phone is connected to the network and synchronisation with the time server is activated. Manual settings are overwritten in this case.

Settings for the time server in the Web configurator: → page 51

▶ ▶ **Settings** ▶ **Date + Time**

To switch between the entry fields: ▶ Swipe up or down or press the Control key up or down

- Date format: ▶ Tap the date format required:  
**DD MM YYYY:** e.g. 17.04.2019 for 17 April 2019  
**MM DD YYYY:** e.g. 04.17.2019
- Date: ▶ Swipe up and down to set the day, month and year
- Time format: ▶ Tap the time format required:  
**24h:** 24 hours, e.g. 10:00, 18:00  
**12h:** 12 hours, e.g. 10:00 AM, 06:00 PM
- Time: ▶ Set the hour and minute by swiping up or down, also select PM or AM in the 12 hour format
- Save settings: ▶ Tap or press the End key ▶ **Save**

## Ringtones

Set the volume and melody for the ringtone and/or completely silence the ringtone for anonymous calls.



### Volume

The volume of the ringtone for incoming calls can be set at 10 levels.

▶  ▶  **Settings** ▶  **Audio Settings** ▶ **Ringtones** ▶ **Volume** ...



the ringtone will be played with the melody set for external calls at the current volume; the volume is shown graphically

▶ Tap the required level or use  to select the volume required ▶

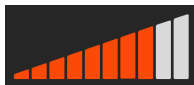
Tap  or press the End key  ... the setting is saved









Changing the volume of the ringtone during an incoming call:

▶ Press the volume keys  (for louder) or  (for quieter)

### Melody

Specify different ringtone melodies for different events (**Default Ringtone**, **External Calls**, **Internal Calls**, **Group Calls**) and VoIP connections.





▶  ▶  **Settings** ▶  **Audio Settings** ▶ **Ringtones** ▶ **Melodies** ▶  Select the event to be indicated by the melody ▶  Select the required melody ▶ Tap  or press the End key  ... the setting is saved



Loading more ringtones onto the phone: → page 46





### Ringtone silencing for anonymous calls

Prevent the telephone ringing when no number is transmitted with an external call.

▶  ▶  **Settings** ▶  **Audio Settings** ▶ **Ringtones** ▶ Enable the switch next to **Anonymous Call Silencing** ( = the phone does not ring for anonymous calls)



### Call volume

The call volume (volume during a call) can be set on 10 levels separately for the receiver, speaker and a headset connected.

▶  ▶  **Settings** ▶  **Audio Settings** ▶ **Call Volume** ▶ 

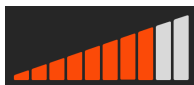
Select **Handset**, **Handsfree** or **Headset** ... the current volume is displayed graphically



▶ Tap the required level or use  to select the volume required ▶ Tap  or press the End key  ... the setting is saved

## Basic settings



Changing the volume during a call:

- ▶ Press the volume keys (for louder) or (for quieter)

---

## Display

### Screensaver

You can choose a digital or analogue clock as the screensaver for the phone's display when in idle status.

- ▶ ▶ **Settings** ▶ **Display** ▶ **Screensaver** ... then
  - Switch on: ▶ next to **Start after**, use to select the time the display spends in idle before the screensaver becomes active (10, 20, 30, 40, 50 or 60 minutes)
  - Select the screensaver: ▶ Tap **Digital Clock** or **Analog Clock** ( = selected)
  - Save the selection: ▶ **Save**
  - Switch off: ▶ Next to **Start after**, use to select **Never** ▶ **Save**

### Exiting the screensaver

- ▶ Press any key **briefly** ... the display changes to idle status



Setting the screensaver from the Web configurator: → page 47

---

## Brightness

The display lighting levels for idle display, normal mode and screensaver are separately adjustable on 10 levels.

- ▶ ▶ **Settings** ▶ **Display** ▶ **Standby brightness | Brightness | Screensaver brightness** ... the current setting is shown graphically ▶ Tap the required level or use to select the brightness required ▶ Tap or press the End key ... the setting is saved

---

## Background colour/image

Change the background image for the start screen. You can select from different images and single-colour motifs. If you have loaded your own images to the phone, they are also offered for selection.

- ▶ ▶ **Settings** ▶ **Display** ▶ **Background** ... the images available are displayed ▶ Select the image you want ( = selected)



To load you own images: → page 47

## Language

Set the language for the display screen.

▶  ▶  **Settings** ▶  **Language** ▶  Select the language ( = selected)



Setting the display language with the Web configurator: → page 47

## Local network

Display network settings for the telephone.

▶  ▶  **Settings** ▶ **Local Network**

- IP Address Type:**      **dynamic or static**
- dynamic**      The telephone obtains its IP address automatically from a DHCP service in the network (the router, for example). The following fields show the current settings. These settings cannot be changed.
- static**      The telephone is provided with a permanent IP address. The administrator makes the network settings using the other fields.
- IP Address:**      The phone's IP address in the local network.
- Subnet Mask:**      The subnet mask for the local network. It specifies how many parts of the IP address make up the network prefix and how many parts make up the device address. The network prefix must be the same for all the devices in the local network.
- Standard Gateway:**      IP address of the system in the local network which assigns the address and forwards information to other networks. This is frequently a router.



Changes to these settings should only be made by the administrator.

### VLAN

A local network can be divided into logical subnetworks known as VLANs (VLAN = Virtual Local Area Network). VLANs are used for example to separate the data traffic of different services (Internet telephony, Internet TV, etc.) and to define different priorities for the data traffic.

Show the phone's VLAN settings.

▶  ▶  Settings ▶ VLAN

**VLAN Tagging:** No, LAN or LAN and PC (when a PC is connected to the phone, → page 5)

For VLAN tagging LAN:

**VLAN Identifier (LAN):** ID of the virtual network to which the phone belongs.

**LAN Priority (LAN):** Priority of the virtual network to which the phone belongs.

Additional parameters for VLAN tagging LAN and PC:

**VLAN Identifier (PC):** ID of the virtual network for the PC.

**LAN Priority (PC):** Priority of the virtual network for the PC.





Changes to these settings can only be made by the administrator.

---

### Restarting the phone

You can restart the device if required. All settings are retained.

▶  ▶  Settings ▶ Reboot ▶ Confirm the prompt with **Reboot now**

---



### Resetting the device to the factory settings



The function can only be run by the administrator.

You can back up your personal settings before a reset: → page 52

A reset returns all the settings to the default settings. Network configuration, VoIP connections, directories, call lists and all the individual settings are deleted or restored to the factory settings.

▶  ▶  Settings ▶ Reset ▶ Confirm the prompt with **Reset now** ▶  Enter the password ▶ OK



### Resetting using the device keys

▶ Disconnect the phone from the power ▶ Press the Control key  ▶ With the key still pressed, reconnect the phone to the power ▶ Release the key after about 10 seconds



## Displaying device information

The menu entry **Info** provides information about important settings on the telephone.

▶  ▶  **Settings** ▶ **Info** . . . the following information is displayed:

<b>Device:</b>	Telephone product name.
<b>SW Version:</b>	Version of the firmware currently loaded on the phone.
<b>Variant:</b>	Country-specific version of the product.
<b>MAC Address:</b>	The phone's device address.
<b>IP Address:</b>	The phone's current IP address within the local network. The IP address is usually set automatically via a DHCP server in the network.
<b>Subnet Mask:</b>	The subnet mask for the local network. It specifies how many parts of the IP address make up the network prefix and how many parts make up the device address. The network prefix must be the same for all the devices in the local network.
<b>Standard Gateway:</b>	IP address of the system in the local network which assigns the address and forwards information to other networks. This is frequently a router.
<b>Preferred DNS:</b>	IP address of the system in the local network providing IP addresses belonging to domain names.



There is more information about the settings and the status of the telephone in the status display of the Web configurator (➔ page 53).

## Configuring other settings with the Web configurator



Your phone is connected to the local network.



This chapter describes the user functions in the Web configurator.

Information for administrators: → [wiki.gigasetpro.com](http://wiki.gigasetpro.com)

## Web configurator

### Finding out the IP address of the phone

You need the IP address of the telephone to access the web configurator.

Displaying the IP address on the phone display:

- ▶ ▶ **Settings** ▶ **Info** ... the IP address is displayed



The IP address can sometimes change, depending on the settings of the DHCP server in your network.

### Starting the web configurator

- ▶ Open the Internet browser on the PC ▶ enter the IP address of the telephone (without any leading zeros) in the address field of the browser ... the login screen is displayed
- ▶ Select the language ▶ Select user role **User** ▶ enter the password (preset: user) ▶ **Login** ... the Web configurator is launched, the **Ringtones** page is displayed

### Changing the password

- ▶ Click on the icon in the top right ▶ select **Change Password** ▶ enter new password ▶ re-enter new password ▶ **Set**



The password can also be changed by the administrator.

### Changing the telephone PIN

The telephone PIN is used to lock the telephone keypad, for example (→ page 15).

- ▶ Click on the icon in the top right ▶ select **Change Phone PIN** ▶ enter current PIN (preset to 1234) ▶ enter new PIN ▶ re-enter new PIN ▶ **Set**

### Changing the language

- ▶ Click on the icon in the top right ▶ select **Change Language** ▶ select required language from the **Language** list ▶ **Set**

### Ending the Web configurator

- ▶ Click on the icon in the top right ▶ select **Logout** ... the login screen is displayed again

## Functions of the Web configurator

The following illustration shows the menu entries of the Web configurator for users.

Information on the administrator functions → [wiki.gigasetpro.com](http://wiki.gigasetpro.com)

Settings	Telephony	Connections	→ page 44
		Call Settings	→ page 44
		Call Divert	→ page 44
		Do not Disturb	→ page 45
	Desk Phone	Ringtones	→ page 46
		Display	→ page 47
		Pictures	→ page 47
		Keys and LEDs	→ page 48
	System	Date and Time	→ page 51
		Save and Restore	→ page 52
		Reboot and Reset	→ page 52
	Status	Device	→ page 53
		Connections	→ page 53
	Storage Allocation	→ page 53	

## Telephony

---

### Changing the standard send connection

If the telephone has more than one VoIP connection, outgoing calls are initiated via the standard send connection (→ page 16).

Changing the standard send connection:

▶ **Settings ▶ Telephony ▶ Connections**

All the configured connections are shown. The check box  under **Default send Connection** shows which connection is currently selected.

▶ Check the connection required ▶ **Set**

Only active connections can be selected.

---

### Settings for Call Waiting

Specify the telephone's response when another call comes in during a call.

▶ **Settings ▶ Telephony ▶ Call Settings**

For each connection:

Prevent/permit Call Waiting:

▶ Select the option under **Display Waiting Call** ( = Call Waiting permitted) / deselect ( = Call Waiting not permitted)

Permit Call Waiting:

▶ Select **Acoustic signal** from the list

**Off:** the incoming call is shown in the display only

or signalling with a Call Waiting tone (beep): once or every 4, 10, or 20 seconds

Save the settings: ▶ **Set**

---

### Setting up Call Divert



The provider/the PABX supports this function.

Forwarding incoming calls to another number or a network mailbox.

▶ **Settings ▶ Telephony ▶ Call Divert**

For each connection (**Incoming line**):

**All Calls** Forward all incoming calls.

**When Busy** Forward incoming calls when the line is busy.

**No Answer** Forward incoming calls after a defined period if they are not accepted.

Specifying the destination of diverted calls:

- ▶ Check the box  under **Voicemail**

or

- ▶ check the box  under **Target number** ▶ enter the number, to which calls are to be diverted

For diverting calls when **No Answer**:

- ▶ From the **Delay** list, select the period after which Call Divert should be activated.

Activating/deactivating Call Divert:

- ▶ Select the option under **Active** ( = activated) / deselect ( = not activated) ▶ **Set**



Setting up Call Divert via the display menu: → page 25

## Do not Disturb



The provider/the PABX supports this function.

Block phone numbers and/or all anonymous calls. Calls from blocked numbers are not signalled.

- ▶ **Settings** ▶ **Telephony** ▶ **Do not Disturb**

The black list contains all the blocked numbers.

Activate the black list: ▶ Set the switch next to **DND list** to **Yes** (**Yes** = activated)

Block a number: ▶ Enter **Name** and **Phone number** of the call ▶ click on **Add**

Delete an entry: ▶ Click next to the entry

Delete all entries: ▶ Click **Delete all**

Block all anonymous calls: ▶ Activate the option **Block anonymous callers** (**Yes** = activated)

Save the settings: ▶ **Set**

## Desk Phone

### Specifying and loading ringtones

Set a ringtone for each configured VoIP connection or use a standard ringtone for all of them.

▶ **Settings ▶ Desk Phone ▶ Ringtones**

#### Selecting ringtones

The standard ringtone is used for connections or events for which no individual ringtone has been set up.

▶ Select a ringtone from the **Default ringtone** list ▶ click on **Play** ... the melody selected is played on the telephone ▶ **Set**

Use the standard ringtone for all calls:

▶ click on **Use for all calls** ▶ **Set**

or

set a different ringtone for each connection:

▶ Select ringtones for the various events from the lists ▶ click on **Play** ... the melody selected is played ▶ **Set**

Different ringtones can be used for the following events: **External Calls, Internal Calls, Group calls**.



Setting ringtones using the display menu: → page 37

### Loading ringtones from the PC

The ringtones available are displayed with a file name and size. A maximum of 20 more ringtones can be loaded into the telephone memory from the PC.

The data on the PC must be in the following format:

Format	Max. number	Total size
mp3, ogg, wav	20	max. 5 MB

▶ Next to the **Ringtone file** click on **Browse** ▶ in the file system of the PC navigate to the location of the ringtone files in the memory and select the file required ... the file name is displayed

Load the ringtone file: ▶ Click on  ... the ringtone file is loaded into the telephone's internal memory and presented for selection in the lists

Delete a ringtone file: ▶ Click on  ... the ringtone file is deleted from the list

Save the settings: ▶ **Set**



Check available space in the memory: → page 53

---

## Settings for the display

Tailor the telephone display to personal preferences and requirements.

▶ **Settings** ▶ **Desk Phone** ▶ **Display**

- Language:** ▶ Select the language to be used for the display from the **Language** list
- Standby Brightness:** ▶ Use the slider to select the display brightness when the phone is in idle status (1 – 10; 1 = dark, 10 = light)
- Backlight:** ▶ Use the slider to select the intensity of the display light (1 – 10; 1 = dark, 10 = light)
- Save the settings: ▶ **Set**



All the settings can also be made through the display menu: ➔ page 38

---

## Loading images and setting the screensaver

An analogue or digital clock is available as the screensaver.

Different images are offered as the background for the start screen. You can also download your own images to the phone.

▶ **Settings** ▶ **Desk Phone** ▶ **Pictures**

### Setting up a screensaver

- ▶ From the **Screensaver Activation** list, select the time the display spends in idle status before the screensaver becomes active. 0 = Screensaver disabled
- ▶ Select from the **Screensaver** list the required screensaver (**Analog clock** or **Digital Clock**)

Save the settings: ▶ **Set**



Setting the screensaver from the display menu: ➔ page 38

## Configuring other settings with the Web configurator

### Loading pictures

You use images as the background for the start screen. In addition to the motifs provided, you can load a maximum of 20 images from your PC to the phone memory. The images available are displayed in the **Stored Pictures** list.

The data must be in the following format on the PC:

Format	Image size	Size
jpg	480 x 272 px	max. 5 MB

▶ Next to **Picture file**, click **Browse** ▶ in the PC file system, navigate to the location of the image files and select the file required ... the file name is displayed

Load an image file: ▶ Click on  ... the image file is loaded into the telephone's memory and presented for selection

Select an image file: ▶ Highlight the image file ( = selected) ... the image file is used as the background for the start screen

If multiple files are selected, they are shown alternately on the display.

Delete an image: ▶ Click on  ... the ringtone file is deleted from the list

Save the settings: ▶ **Set**



Check available space in the memory: → page 53

---

### Assigning quick dial keys

Assign a quick dial number or function to the phone's  –  keys.

Select with quick dial: → page 17

▶ **Settings** ▶ **Desk Phone** ▶ **Keys and LEDs**

The **Quick Dial Keys** table contains an entry each for keys 1 - 4.

Assigning a function:

▶ Click the entry ▶ Select function from the list ▶ **Set**

**Default** The key has the standard function (digit key).

**Quick Dial** The key is used for quick dialling a number

▶ Enter the number in the text field

**FAC** (Function Access Code) The key sends a code to the phone system or provider to enable/disable a function or service.

▶ Enter the code in the text field

Example: \*71 Enable call divert

\*071 Disable call divert

**Action URL** The key is used to call an Action URL. An Action URL is used by the phone to communicate with a Web server application.

▶ Enter the URL in the text field



## Assigning function keys

Function keys: → page 10

▶ **Settings** ▶ **Desk Phone** ▶ **Keys and LEDs**

The **Function Keys - Idle Screen** and **Screen 1 - Screen 2** tables contain an entry for every function key.



If an expansion module is connected to the phone, more function keys are available in **Function Keys - Expansion Module**. They are assigned exactly the same way as the function keys on the display.

<b>Key</b>	Name of the key, denotes the position of the key. Key 1 is always in the top left. The other keys are arranged from the top down and from left to right.
<b>Function</b>	Function assigned to the key.
<b>LED colour</b>	Colour with which the key signals an event, such as an incoming call. On the keys on the expansion module, the LEDs are used for the display. Change colour: ▶ Click the entry ▶ Select the colour required

### No Auto Provisioning

Function keys can automatically be assigned via a PABX. Preventing the key from being overwritten by the PABX:

▶ Activate the option ( = activated)

Assigning a function:

▶ Click the entry ▶ Select function from the list ▶ **Set**

Possible functions:

<b>No function</b>	No function assigned.
<b>Line</b>	Assigns a specific connection (line) to the function key. The key is used to initiate or accept a call on this connection. The key flashes if a call comes in and lights up if the line is busy. ▶ Select the desired connection
<b>Shared Line</b>	The telephone is connected to a PABX which supports this function and the number is assigned to a group. Assigns a "shared line" to the function key. This means several users share the same VoIP connection. The key is used to make a call via the shared connection or to answer an incoming call. It is configured on all extensions of the group. The keys flash on all extensions when a call arrives, and light up when the line on any extension is busy. ▶ Select the required connection ▶ Enter the <b>Phone number</b> of the "shared line"

## Configuring other settings with the Web configurator

- Park + Retrieve** The phone is connected to a PABX which supports this function and the number is assigned to a group.  
This function key allows you to “park” a call to transfer it within a group using a shared line. It is configured on all extensions of the group. The “Park + Retrieve” keys on all extensions light up when a call is “parked” on an extension. The call can be picked up on any extension by pressing the key.
- ▶ Select the required connection ▶ Enter the **Parking Space** (number) of the shared line
- Quick Dial** Assigns a number to the function key.
- ▶ Select the desired connection ▶ Enter the **Target number**
- BLF** (Busy Lamp Field) The phone is connected to a PABX which supports this function and the number is assigned to a group.  
A function key that is configured as BLF indicates the status of a shared line. It is configured on all extensions of the group. The keys flash on all extensions when a call arrives, and light up when the line on any extension is busy.
- ▶ Select the desired connection ▶ Enter the **Target number**
- Accept incoming calls: ▶ Enter **Call Pickup Code**
- SIP URI** Assigns the function key a SIP URI (Internet phone number in SIP notation).
- ▶ Enter the SIP URI (e.g. sip:Susan.Brown@211.122.10.15)
- Call Divert** Enable the call divert set up previously (⇒ page 44).
- ▶ Select the **Line** for which the call divert is set up
- DTMF** Assigns the function key a number dialled using DTMF. This is used for example for querying network mailboxes using digit codes, for controlling dialogue systems (IVR) and for dialling into a conference call by entering a PIN.
- ▶ Enter the number to be dialled using DTMF signalling.
- Action URL** Assigns an Action URL to the function key. An Action URL is used by the phone to communicate with a Web server application.
- ▶ Enter the URL in the text field
- SIP Info** Assigns the function key a SIP INFO call to the PABX. The following calls can be assigned:
- |                    |   |
|--------------------|---|
| <b>Record</b>      | Start/stop call recording               |
| <b>Divert CFU</b>  | Divert all calls                        |
| <b>Divert CFB</b>  | Divert calls when the phone is busy     |
| <b>Divert CFNR</b> | Divert calls when they are not accepted |
| <b>Day/Night</b>   | Enable/disable day/night activation     |
- FAC** (Function Access Code) The key sends a code to the phone system or provider to enable/disable a function or service.  
Example:  
\*71 Enable call divert  
\*071 Disable call divert

- ▶ In the **Display Name** field, enter a description for the function key. This name is shown on the display next to the function key.

For the **Line**, **BLF** and **FAC** key assignments, you can select the LED colour.

- ▶ Select the required colour next to **LED colour**

For key assignments **Line** and **BLF**, the selection **Standard** means:

Yellow	Not registered with the provider/phone system, or error
Green	Free
Permanently red	Conversation ongoing
Flashing red	Incoming call

Save the settings: ▶ **Set**

## System settings

### Date and time

The date and time can be set manually or using a time server.

- ▶ **Settings ▶ System ▶ Date and Time**

- ▶ From the **Automatic adjustment of system time with Time Server** list, select how the date and time are to be set.

#### With time server





- ▶ Select one of the following options:

<b>Provisioning</b>	The date and time are set automatically. The time server is specified using provisioning (such as on a PABX).
<b>DHCP Option 42</b>	The time server is determined with DHCP Option 42.
<b>Manual</b>	The date and time are set automatically by a time server you specify yourself. <ul style="list-style-type: none"> <li>▶ In the <b>Time Server</b> field, enter the name or IP address of the required server</li> </ul>

The most recent synchronisation carried out with the time server is shown.

#### Entering manually

- ▶ From the **Automatic adjustment of system time with Time Server** list, select option **Local**

<b>Time:</b>	▶ Set the time using the arrows	 
<b>Date:</b>	▶  Open the calendar ▶ Select the date	 06 : 32 

## Configuring other settings with the Web configurator

### Other settings

- Time Zone:** ▶ Select the time zone from the list
- Summer time:** ▶ **Automatically adjust clock for daylight saving changes:** Select **Yes/No**
- Time format:** ▶ Select the time format from the list:  
**12h** (e.g. 6:00 AM) or **24h** (e.g. 18:00)
- Date order:** ▶ Select the date format from the list:  
**Day Month Year** (e.g. 17.04.2019) or  
**Month Day Year** (e.g. 04.17.2019)
- Save the settings: ▶ **Set**



Setting the time and date with the display menu: → page 36

---

## Saving and restoring settings

Save data from the telephone to the PC and restore it back to the telephone if necessary.

- ▶ **Settings** ▶ **System** ▶ **Save and Restore**

### Save Device settings to PC

All settings: System settings and personal settings  
(only possible as administrator)

Personalised settings: e. g. directory entries, ringtones, display settings, function key assignments

- ▶ click **Save personalized settings**
- ▶ select a storage location on the PC ▶ save file

### Restore device settings from PC

- ▶ Click **Browse** ▶ select the stored back-up file from the file system ... the file is displayed ▶ click  ... the file is loaded; a message indicates whether the loading process has been successful or not ▶ confirm the message with **OK**

Deleting unwanted back-up files: ▶ click 

---

## Restarting the system

- ▶ **Settings** ▶ **System** ▶ **Reboot and Reset** ▶ Click **Reboot system now** ▶ confirm prompt with **Yes** ... the telephone is rebooted and temporarily not ready for operation

Once this has been completed, the login screen is displayed again, the telephone is in idle status.



Resetting is only possible as administrator.

## Status of the telephone

The **Status** menu contains information about the status of the telephone.

### Device

The screen shows general information about the phone, such as the IP address, the current firmware version and the date and time settings.

▶ **Status** ▶ **Device**

### Connections

The page shows information about the VoIP connections configured for the telephone.

▶ **Status** ▶ **Connections** . . . name and status are shown for each connection

<b>Status</b>	<b>Registered</b>	VoIP connection available.
	<b>Not registered</b>	Currently there is no VoIP connection assigned. The telephone cannot be used.
		▶ Please contact the administrator

The **Default send Connection** is marked with .



Changing the standard send connection: → page 44

### Storage Allocation

The page shows the memory space occupied by the internal memory and how much is still available (in percent). Ringtone files are stored in the internal memory, for example.

▶ **Status** ▶ **Storage Allocation**

## Appendix

---

### Customer Service & Help

Do you have any questions?

For quick help and information, please refer to this user guide or visit [gigasetpro.com](http://gigasetpro.com).

For online information and services concerning

- Products
- Documents
- Interop
- Firmware
- FAQ
- Support

please refer to [wiki.gigasetpro.com](http://wiki.gigasetpro.com).

For further information our Gigaset specialised reseller will be happy to help you related to your Gigaset product.

---

### Manufacturer's advice

---

#### Authorisation

Voice over IP telephony is possible via the LAN interface (IEEE 802.3).

Depending on your telecommunication network interface, an additional router/switch could be necessary.

For further information please contact your Internet provider.

This device is intended for use worldwide. Use outside the European Economic Area (with the exception of Switzerland) is subject to national approval.

Country-specific requirements have been taken into consideration.

Hereby, Gigaset Communications GmbH declares that the radio equipment type Gigaset Maxwell 4 is in compliance with Directive 2014/53/EU.

The full text of the EU declaration of conformity is available at the following internet address: [gigasetpro.com/docs](http://gigasetpro.com/docs).

This declaration could also be available in the "International Declarations of Conformity" or "European Declarations of Conformity" files.

Therefore please check all of these files.

---

## Data protection

We at Gigaset take the protection of our customers' data very seriously. It is precisely for this reason that we are ensuring all our products feature "Privacy by Design" as standard. All information we collect is used to make our products as good as possible. In the process, we ensure your details are protected and only used for the purposes of making available to you a product or service. We know which path your data takes through the company and ensure this happens in line with data protection specifications in a secure and protected manner.

The full text of the privacy policy is available from: [gigaset.com/privacy-policy](https://gigaset.com/privacy-policy)

---

## Environment

### Our environmental statement

We at Gigaset Communications GmbH are aware of our social responsibility. That is why we actively take steps to create a better world. In all areas of our business – from product planning and production to sales and waste of disposal – following our environmental conscience in everything we do is of utmost importance to us.

Learn more about our earth-friendly products and processes online at [gigasetpro.com](https://gigasetpro.com).

---

### Environmental management system



Gigaset Communications GmbH is certified pursuant to the international standards ISO 14001 and ISO 9001.

**ISO 14001 (Environment):** Certified since September 2007 by TÜV SÜD Management Service GmbH.

**ISO 9001 (Quality):** Certified since 17/02/1994 by TÜV SÜD Management Service GmbH.

---

### Disposal

All electrical and electronic products should be disposed of separately from the municipal waste stream via designated collection facilities appointed by the government or the local authorities.



This crossed-out wheeled bin symbol on the product means the product is covered by the European Directive 2012/19/EU.

The correct disposal and separate collection of your old appliance will help prevent potential negative consequences for the environment and human health. It is a precondition for reuse and recycling of used electrical and electronic equipment.

For more detailed information about disposal of your old appliance, please contact your local council refuse centre or the original supplier of the product.

## Care

Wipe the device with a **damp** cloth or an antistatic cloth. Do not use solvents or microfibre cloths.

**Never** use a dry cloth; this can cause static.

In rare cases, contact with chemical substances can cause changes to the device's exterior. Due to the wide variety of chemical products available on the market, it was not possible to test all substances.

Impairments in high-gloss finishes can be carefully removed using display polishes for mobile phones.

---

## Contact with liquid

If the device comes into contact with liquid:

- 1 **Unplug all cables from the device.**
- 2 Allow the liquid to drain from the device.
- 3 Pat all parts dry.
- 4 Place the device in a dry, warm place **for at least 72 hours (not in a microwave, oven etc.)** with the keypad facing down (if applicable).
- 5 **Do not switch on the device again until it is completely dry.**

When it has fully dried out, you will normally be able to use it again.



---

## Open Source Software

---

### General

Your Gigaset device includes Open Source software that is subject to various license conditions. With regard to Open Source software, the granting of usage rights that go beyond the operation of the device in the form supplied by Gigaset Communications GmbH is governed by the relevant license conditions of the Open Source software.

The respective license texts regularly contain limitations of liability with regard to the relevant licensor of Open Source Software. The exclusion of liability for the GPL Version 2, for example, reads as follows:

"This program is distributed in the hope that it will be useful, but WITHOUT ANY WARRANTY; without even the implied warranty of MERCHANTABILITY or FITNESS FOR A PARTICULAR PURPOSE. See the GNU General Public License for more details."

and for the LGPL Version 2.1:

"This library is distributed in the hope that it will be useful, but WITHOUT ANY WARRANTY; without even the implied warranty of MERCHANTABILITY or FITNESS FOR A PARTICULAR PURPOSE. See the GNU Lesser General Public License for more details."

The liability of Gigaset Communications GmbH remains unaffected by this.

---

### Licence and copyright information

Your Gigaset unit includes Open Source software which is subject to the GNU General Public License (GPL) or the GNU Library/Lesser General Public License (LGPL). The corresponding licence conditions in their original version and the relevant source code can be found in the Internet at [gigasetpro.com/opensource](http://gigasetpro.com/opensource). The appropriate source code can also be requested from Gigaset Communications GmbH at cost price within three years of purchasing the product. Please use the contact details provided at [gigasetpro.com/service](http://gigasetpro.com/service).

## Menu tree







The following illustration shows the full menu tree of the display menu.

Contacts	Local Directory					→ page 31
	Enterprise					→ page 34
Select Services	Call Divert					→ page 25
	Withhold Number					→ page 18
	Call Waiting					→ page 22
	Active Ring-backs					→ page 18
Settings	Date + Time					→ page 36
	Audio Settings	Ringtones	Volume			→ page 37
			Melodies	Default Ring-tone		→ page 37
				External Calls		→ page 37
				Internal Calls		→ page 37
				Group Calls		→ page 37
			Anonymous Call Silencing			→ page 37
		Call Volume	Handset			→ page 37
			Handsfree			→ page 37
			Headset			→ page 37
	Display	Screensaver				→ page 38
		Screensaver Brightness				→ page 38
		Standby brightness				→ page 38
		Brightness				→ page 38
		Background				→ page 38
	Language					→ page 39
	Local Network					→ page 39
	VLAN					→ page 40
	Reset	for administrators only				→ page 40
	Reboot					→ page 40
	Info					→ page 41





## Display icons

The following icons are displayed depending on the settings and the operating status of your telephone.





### Icons in the status bar

Icon	Meaning
	No VoIP connection
	USB device connected
	Keypad lock activated
	Ringtone deactivated
	Headset connected over USB
	Voice message on an answering machine

### Display icons to indicate . . .







Icon	Meaning
	Incoming call
	Establishing a connection (outgoing call)
	Connection established
	No connection established / connection terminated
	Conference established

### Symbols for the function keys

Icon	Meaning
	Line
	Quick Dial, Park + Retrieve, BLF
	Call Divert, FAC, DTMF
	SIP URI
	SIP Info

## Display icons

### Other display icons

Icon	Meaning
	Action complete (green)
	Action failed (red)
	Information
	Warning
	(Security) prompt
	Open Options menu
	Searching for an entry

# Index

- 
- A**
- Accepted calls . . . . . 27
  - Activating DTMF using a function key . . . . . 50
  - Analogue clock, as screensaver . . . . . 38
  - Anonymous calling . . . . . 18
  - Authorisation . . . . . 54
- 
- B**
- Back key . . . . . 4
  - Background colour . . . . . 38
  - Background image . . . . . 38
  - Black list . . . . . 45
  - BLF (Busy Lamp Field) . . . . . 50
- 
- C**
- Call
    - accept . . . . . 19
    - anonymous . . . . . 18
    - block . . . . . 45
    - during number entry . . . . . 16
    - forwarding . . . . . 25
    - in call list . . . . . 27
    - incoming . . . . . 19
    - information . . . . . 27
    - initiate . . . . . 16
    - outgoing . . . . . 16
    - rejecting . . . . . 19
  - Call divert
    - set up (display menu) . . . . . 25
    - set up (Web configurator) . . . . . 44
  - Call forwarding
    - disable . . . . . 26
  - Call list . . . . . 27
    - accepted calls . . . . . 27
    - all calls . . . . . 27
    - clear . . . . . 28
    - copying a number to the directory . . . . . 28
    - delete entry . . . . . 28
    - dialling a number . . . . . 17, 27
    - missed calls . . . . . 27
    - opening . . . . . 27
    - outgoing calls . . . . . 27
  - Call swapping . . . . . 24
  - Call volume . . . . . 37
  - Call waiting . . . . . 24
    - accepting a call . . . . . 22
    - activating/deactivating . . . . . 22
    - rejecting a call . . . . . 22
    - settings (Web configurator) . . . . . 44
  - Caller
    - name on display . . . . . 19
    - picture on display . . . . . 19
  - Caller display . . . . . 18
  - Caller picture . . . . . 19
- 
- Calls
    - put on hold . . . . . 22
  - Care . . . . . 56
  - Care of the device . . . . . 56
  - Change telephone PIN . . . . . 42
  - Change the volume . . . . . 21
  - Company directory . . . . . 34
    - displaying an entry . . . . . 35
    - open . . . . . 34
  - Conference call . . . . . 24
  - Conference call key . . . . . 4
  - Connection . . . . . 44
    - expansion module . . . . . 5
    - headset . . . . . 5
    - LAN . . . . . 5
    - PC . . . . . 5
    - power adapter . . . . . 5
    - receiver . . . . . 5
    - status . . . . . 53
  - Consultation call . . . . . 22
  - Consultation call key . . . . . 4, 22
  - Contact with liquid . . . . . 56
  - Control key . . . . . 4, 12
  - Copying a number
    - from the call list to the directory . . . . . 28
  - Corporate directory
    - searching for entry . . . . . 34
  - Correcting incorrect entries . . . . . 14
  - Correction of incorrect entries . . . . . 14
  - Country version . . . . . 41
  - Customer Care . . . . . 54
  - Customer Service . . . . . 54
- 
- D**
- Data protection . . . . . 55
  - Date format . . . . . 36, 52
  - Deactivating the microphone . . . . . 21
  - Default setting see Factory settings
  - Delete numbers . . . . . 16
  - Device, status . . . . . 53
  - Dialling a number
    - from the call list . . . . . 17, 27
    - from the company directory . . . . . 35
    - from the directory . . . . . 17, 33
    - from the redial list . . . . . 17
    - using a quick dial key . . . . . 17
    - via function key . . . . . 17
    - via the keypad . . . . . 16
  - Dialling numbers
    - cancelling . . . . . 16
  - Digital clock, as screensaver . . . . . 38
  - Directories . . . . . 31
  - Directory entry
    - change . . . . . 33
    - delete . . . . . 33
    - in the corporate directory . . . . . 34

## Index

- Directory, local  
  changing an entry . . . . . 33  
  copying a number from the call list . . . . . 28  
  delete . . . . . 33  
  delete entry . . . . . 33  
  open . . . . . 31
- Display . . . . . 9  
  brightness when phone is in idle status . . . . . 47  
  caller display . . . . . 19  
  contrast . . . . . 47  
  menu tree . . . . . 58  
  returning to idle status . . . . . 14
- Display icons . . . . . 59
- Display illumination  
  set brightness (display menu) . . . . . 38
- Display MAC address . . . . . 41
- Display menu . . . . . 58
- Disposal . . . . . 55
- Do not disturb (DND) . . . . . 20, 45
- Do Not Disturb key . . . . . 4, 20  
  LED . . . . . 4
- 
- E**
- Emergency numbers  
  not possible . . . . . 8
- End key . . . . . 4
- Ending  
  a call . . . . . 21
- Entering letters . . . . . 14
- Entering numbers . . . . . 14
- Entering text . . . . . 14
- Environment . . . . . 55
- Event list . . . . . 11
- Expansion module . . . . . 49
- Expansion module, connection . . . . . 5
- 
- F**
- Factory settings . . . . . 40
- Firmware version . . . . . 41, 53
- Forwarding a call . . . . . 25
- Function key . . . . . 17  
  BLF . . . . . 50  
  Colour . . . . . 11  
  connection . . . . . 49  
  DTMF . . . . . 50  
  Park + Retrieve . . . . . 50  
  quick dial . . . . . 50  
  shared line . . . . . 49
- Function keys . . . . . 10
- 
- G**
- GPL . . . . . 57
- 
- H**
- Handset  
  changing volume . . . . . 21
- Handsfree  
  switching on/off . . . . . 21
- Handsfree key . . . . . 4, 21  
  LED . . . . . 4
- Handsfree mode . . . . . 16  
  changing volume . . . . . 21
- Hash key . . . . . 3
- Headset  
  changing volume . . . . . 21  
  using to make calls . . . . . 16  
  volume . . . . . 37
- Headset connection . . . . . 5
- Headset key . . . . . 4  
  LED . . . . . 4
- Help . . . . . 54
- 
- I**
- Icons  
  indications . . . . . 59  
  status bar . . . . . 59
- Idle display . . . . . 9
- Idle status, returning to . . . . . 14
- Image  
  load . . . . . 48
- Indications, icons . . . . . 59
- Information on the telephone . . . . . 41
- Initiate consultation call  
  from the directory . . . . . 23
- IP address . . . . . 41  
  dynamic . . . . . 39  
  finding via the display . . . . . 42  
  finding via the Web configurator . . . . . 53  
  obtaining automatically . . . . . 39  
  static . . . . . 39
- 
- K**
- Key  
  conference call . . . . . 4  
  consultation call . . . . . 4, 22  
  control key . . . . . 4  
  do not disturb . . . . . 4, 20  
  end/back . . . . . 4  
  handsfree . . . . . 21  
  handsfree mode . . . . . 4  
  hash . . . . . 3  
  headset . . . . . 4  
  message . . . . . 29  
  message centre . . . . . 4  
  mute . . . . . 4  
  star . . . . . 3  
  volume . . . . . 3, 21
- Keypad  
  locking/unlocking . . . . . 15
- Keypad lock  
  changing the PIN . . . . . 42  
  PIN . . . . . 15

<b>L</b>	
LAN connection	5
Language for the display screen setting (display menu)	39
<b>LED</b>	
do not disturb key	4
handsfree key	4
headset key	4
message key	4
mute key	4
LED colour	51
LGPL	57
<b>Line</b>	
selecting for call	16
Liquid	56
<b>M</b>	
Main menu	13
Making calls	16
Manufacturer's advice	54
Menu	13
navigation	12, 13
opening	13
<b>Menu tree</b>	
display	58
web configurator	43
Message Centre	4, 29
Message key	4, 29
LED	4
Missed calls	27
on idle display	10
Mute key	4
LED	4
Muting	21
<b>N</b>	
<b>Number</b>	
showing on display	19
<b>O</b>	
Open Source Software	57
<b>P</b>	
<b>Park + Retrieve</b>	
assigning a function key	50
PC connection	5
<b>Phone</b>	
rebooting	52
<b>Picture</b>	
delete	48
<b>Port</b>	
USB	5
Power adapter	8
Power adapter, connection	5
Put on hold	22
<b>Q</b>	
Quick dial	50
Quick dial key	17
<b>R</b>	
<b>Receiver</b>	
connection	5
volume	37
Redial list	27
dialling a number	17
Restart	40, 52
<b>Restore factory settings</b>	
using the device keys	40
using the display menu	40
<b>Ringback</b>	
initiate	18
<b>Ringtone</b>	
activating/deactivating	20
delete	46
load	46
set using the display menu	37
set using the Web configurator	46
setting the melody	37
standard	46
volume for incoming calls	37
<b>S</b>	
Safety precautions	8
<b>Screensaver</b>	
enable/disable (display menu)	38
setup	38, 47
<b>Setting the date</b>	
display menu	36
Setting the language for the Web configurator	42
<b>Setting the time</b>	
display menu	36
<b>Shared line</b>	
assigning function key	49, 50
<b>Speaker</b>	
volume	37
Specifying the time zone	52
Standard connection	10
Standard ringtone	46
Standard send connection	16
change	44
display	53
Star key	3
Start screen	9
<b>Status</b>	
connections	53
device	53
memory assignment	53
Status bar	10
icons	59
Storage allocation	53
Submenu	13
Summer time	52

## Index

SW version see Firmware version

System settings	
date and time . . . . .	51
saving/restoring . . . . .	52

---

## T

Telephone	
connections . . . . .	5
keys . . . . .	3
Telephone settings	
in display menu. . . . .	36
in the Web configurator. . . . .	42
Time . . . . .	10
Time format . . . . .	36, 52
Time server . . . . .	36, 53
defining . . . . .	51
Touch screen. . . . .	3

---

## U

USB port . . . . .	5
--------------------	---

---

## V

VLAN (Virtual Local Area Network) . . . . .	40
Voice mail . . . . .	30
playing . . . . .	30
VoIP connection . . . . .	16, 44
Volume for ringtone. . . . .	37
Volume key . . . . .	3, 21

---

## W

Web configurator	
accessing . . . . .	42
changing password . . . . .	42
de-registration . . . . .	42
menu structure (users) . . . . .	43
selecting language . . . . .	42
settings . . . . .	42
starting . . . . .	42



Issued by

Gigaset Communications GmbH

Frankenstr. 2a, D-46395 Bocholt

© Gigaset Communications GmbH 2019

Subject to availability.

All rights reserved. Rights of modification reserved.

[gigasetpro.com](http://gigasetpro.com)